

HISTORY INFORMATION FOR THE FOLLOWING MANUAL:

SERVICE MANUAL

BA-5D CHASSIS

<u>MODEL NAME</u>	<u>REMOTE COMMANDER</u>	<u>DESTINATION</u>	<u>CHASSIS NO.</u>
KV-27FV300	RM-Y181	US	SCC-S65AA
KV-27FV300	RM-Y181	CND	SCC-S64AA
KV-29FV300	RM-Y181	LATIN NORTH	SCC-S62BA
KV-29FV300	RM-Y181	LATIN SOUTH	SCC-S62CA
KV-32FV300	RM-Y182	US	SCC-S65BA
KV-32FV300	RM-Y182	CND	SCC-S64BA
KV-36FV300	RM-Y182	US	SCC-S65CA
KV-36FV300	RM-Y182	CND	SCC-S64CA
KV-36FV300	RM-Y182	HAWAII	SCC-S67AA

ORIGINAL MANUAL ISSUE DATE: 3/2002

ALL REVISIONS AND UPDATES TO THE ORIGINAL MANUAL ARE APPENDED TO THE END OF THE PDF FILE.

<u>REVISION DATE</u>	<u>REVISION TYPE</u>	<u>SUBJECT</u>
3/2002	No revisions or updates are applicable at this time.	
5/2002	Correction - 1	Critical parts incorrectly identified in Exploded View, Electrical Parts List, A Board Schematic.
10/2002	Correction - 2	Exploded View PN correction for Door

TRINITRON® COLOR TELEVISION
SONY®

SERVICE MANUAL

BA-5D CHASSIS

<u>MODEL NAME</u>	<u>REMOTE COMMANDER</u>	<u>DESTINATION</u>	<u>CHASSIS NO.</u>
KV-27FV300	RM-Y181	US	SCC-S65AA
KV-27FV300	RM-Y181	CND	SCC-S64AA
KV-29FV300	RM-Y181	LATIN NORTH	SCC-S62BA
KV-29FV300	RM-Y181	LATIN SOUTH	SCC-S62CA
KV-32FV300	RM-Y182	US	SCC-S65BA
KV-32FV300	RM-Y182	CND	SCC-S64BA
KV-36FV300	RM-Y182	US	SCC-S65CA
KV-36FV300	RM-Y182	CND	SCC-S64CA
KV-36FV300	RM-Y182	HAWAII	SCC-S67AA



KV-36FV300



RM-Y182

TRINITRON® COLOR TELEVISION

SONY®

TABLE OF CONTENTS

SECTION TITLE	PAGE
Specifications.....	4
Warnings and Cautions.....	5
Safety Check-Out	6
Self-Diagnostic Function.....	7
1. Disassembly	
1-1. Rear Cover Removal	10
1-2. Chassis Assembly Removal	10
1-3. Service Position	10
1-4. Picture Tube Removal	11
Anode Cap Removal Procedure.....	11
2. Set-up Adjustments	
2-1. Beam Landing	12
2-2. Convergence	13
2-3. Focus.....	15
2-4. Screen (G2).....	15
2-5. White Balance Adjustments.....	15
3. Safety Related Adjustments	
3-1. <input checked="" type="checkbox"/> R530, R531 Confirmation Method (Hold-Down Confirmation) and Readjustments	16
3-2. B+ Voltage Confirmation and Adjustment	16
4. Circuit Adjustments	
4-1. Setting Service Adjustment Mode.....	17
4-2. Memory Write Confirmation Method	17
4-3. Remote Adjustment Buttons and Indicators	17
4-4. Service Data Lists.....	18
4-5. ID Map Table	26
4-6. Board Adjustments	26
5. Diagrams	
5-1. Circuit Board Location	29
5-2. Printed Wiring Board and Schematic Diagrams Information	29
5-3. Block Diagram and Schematics.....	30
A Board Schematic Diagram	31
BC Board Schematic Diagram	39
HU Board Schematic Diagram.....	42
P Board Schematic Diagram	44
HR Board Schematic Diagram.....	46
T Board Schematic Diagram.....	47
C Board Schematic Diagram	48
V Board Schematic Diagram	50
GK Board Schematic Diagram.....	52
5-4. Semiconductors	54
6. Exploded Views	
6-1. Chassis (KV-27FV300/29FV300 ONLY).....	55
6-2. Picture Tube (KV-27FV300/29FV300 ONLY)	56
6-3. Chassis (KV-32FV300 ONLY)	57
6-4. Picture Tube (KV-32FV300 ONLY)	58
6-5. Chassis (KV-36FV300 ONLY)	59
6-6. Picture Tube (KV-36FV300 ONLY)	60
7. Electrical Parts List	61

SPECIFICATIONS

	KV-27FV300 KV-29FV300	KV-32FV300	KV-36FV300
Power Requirements	120V, 60Hz		
Number of Inputs/Outputs			
Video ¹⁾	3		
S Video ²⁾	2		
Y, P_B, P_R ³⁾	1		
Audio ⁴⁾	3		
Audio Out ⁵⁾	1		
Monitor Out	1		
Speaker Output (W)	7.5 W x 2, 15 W subwoofer		
Power Consumption (W)			
In Use (Max)	220 W	230 W	230 W
In Standby	1W	1W	1W
Dimensions (W x H x D)			
mm	784 x 601.5 x 520 mm	898 x 682 x 584 mm	1020 x 760 x 640 mm
in	30 ^{7/8} x 23 ^{11/16} x 20 ^{1/2} in	35 ^{3/8} x 26 ^{7/8} x 23 in	40 ^{1/4} x 30 x 25 ^{1/4} in
Mass			
kg	48 kg	78 kg	102 kg
lbs	105 lbs. 13 oz.	171 lbs. 15 oz.	224 lbs. 14 oz.

Television system

American TV standard, NTSC

Channel coverage

VHF: 2-13/ UHF: 14-69/ CATV: 1-125

Picture tubeFD Trinitron[®] tube**Visible screen size**

27 inch picture measured diagonally (KV-27FV300/29FV300)

32 inch picture measured diagonally (KV-32FV300)

36 inch picture measured diagonally (KV-36FV300)

Actual screen size

29 inch measured diagonally (KV-27FV300/29FV300)

34 inch measured diagonally (KV-32FV300)

38 inch measured diagonally (KV-36FV300)

Antenna

75-ohm external antenna terminal for VHF/UHF

Supplied Accessories

Size AA (R6) batteries (2)

Remote Control RM-Y181 (1) (KV-27FV300/29FV300)

Remote Control RM-Y182 (1) (KV-32FV300/36FV300)

Wireless Headphones (1) (KV-32FV300/36FV300)

Optional Accessories

TV Stand: SU-27HV2 for (KV-27KV300/29FV300)

SU-32HV3 for (KV-32KV300)

SU-36HV3 for (KV-36KV300)

Design and specifications are subject to change without notice.

- 1) 1 Vp-p 75 ohms unbalanced, sync negative
- 2) Y: 1 Vp-p 75 ohms unbalanced, sync negative
C: 0.286 Vp-p (Burst signal), 75 ohms
- 3) Y: 1.0 Vp-p, 75 ohms, sync negative;
PB: 0.7 Vp-p, 75 ohms
PR: Vp-p, 75 ohms
- 4) 500 mVrms (100% modulation), Impedance: 47 kilohms
- 5) More than 408 mVrms at the maximum volume setting (variable)
More than 408 mVrms (fix)

XBR

TruSurround[™]
by SRS (●)

TruSurround is a trademark of SRS Labs, Inc. SRS and the SRS symbol are registered trademarks of SRS Labs, Inc. in the United States and in select foreign countries. SRS and TruSurround are incorporated under license from SRS Labs, Inc. and are protected under United States Patent Nos. 4,748,669 and 4,841,572 with numerous additional issued and pending foreign patents. Purchase of this product does not convey the right to sell recordings made with the TruSurround technology.

(●) SRS (SOUND RETRIEVAL SYSTEM)

The (●) SRS (SOUND RETRIEVAL SYSTEM) is manufactured by Sony Corporation under license from SRS Labs, Inc. It is covered by U.S. Patent No. 4,748,669. Other U.S. and foreign patents pending.

The word 'SRS' and the SRS symbol (●) are registered trademarks of SRS Labs, Inc. BBE and BBE symbol are trademarks of BBE Sound, Inc. and are licensed by BBE Sound, Inc. under U.S. Patent No. 4,638,258 and 4,482,866.

WARNINGS AND CAUTIONS

CAUTION

Short circuit the anode of the picture tube and the anode cap to the metal chassis, CRT shield, or carbon painted on the CRT, after removing the anode.

WARNING!!

An isolation transformer should be used during any service to avoid possible shock hazard, because of live chassis. The chassis of this receiver is directly connected to the ac power line.



SAFETY-RELATED COMPONENT WARNING!!

Components identified by shading and mark on the schematic diagrams, exploded views, and in the parts list are critical for safe operation. Replace these components with Sony parts whose part numbers appear as shown in this manual or in supplements published by Sony. Circuit adjustments that are critical for safe operation are identified in this manual. Follow these procedures whenever critical components are replaced or improper operation is suspected.

ATTENTION!!

Après avoir déconnecté le cap de l'anode, court-circuiter l'anode du tube cathodique et celui de l'anode du cap au châssis métallique de l'appareil, ou la couche de carbone peinte sur le tube cathodique ou au blindage du tube cathodique.

Afin d'éviter tout risque d'électrocution provenant d'un châssis sous tension, un transformateur d'isolement doit être utilisé lors de tout dépannage. Le châssis de ce récepteur est directement raccordé à l'alimentation du secteur.



ATTENTION AUX COMPOSANTS RELATIFS A LA SECURITE!!

Les composants identifiés par une trame et par une marque sur les schémas de principe, les vues explosées et les listes de pièces sont d'une importance critique pour la sécurité du fonctionnement. Ne les remplacer que par des composants Sony dont le numéro de pièce est indiqué dans le présent manuel ou dans des suppléments publiés par Sony. Les réglages de circuit dont l'importance est critique pour la sécurité du fonctionnement sont identifiés dans le présent manuel. Suivre ces procédures lors de chaque remplacement de composants critiques, ou lorsqu'un mauvais fonctionnement suspecte.

SAFETY CHECK-OUT

After correcting the original service problem, perform the following safety checks before releasing the set to the customer:

1. Check the area of your repair for unsoldered or poorly soldered connections. Check the entire board surface for solder splashes and bridges.
2. Check the interboard wiring to ensure that no wires are “pinched” or touching high-wattage resistors.
3. Check that all control knobs, shields, covers, ground straps, and mounting hardware have been replaced. Be absolutely certain that you have replaced all the insulators.
4. Look for unauthorized replacement parts, particularly transistors, that were installed during a previous repair. Point them out to the customer and recommend their replacement.
5. Look for parts which, though functioning, show obvious signs of deterioration. Point them out to the customer and recommend their replacement.
6. Check the line cords for cracks and abrasion. Recommend the replacement of any such line cord to the customer.
7. Check the B+ and HV to see if they are specified values. Make sure your instruments are accurate; be suspicious of your HV meter if sets always have low HV.
8. Check the antenna terminals, metal trim, “metallized” knobs, screws, and all other exposed metal parts for AC leakage. Check leakage as described below.

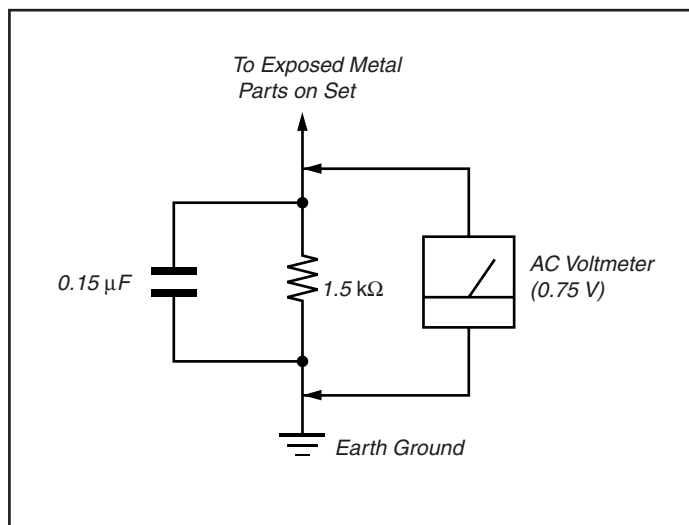

Figure A. Using an AC voltmeter to check AC leakage.

Leakage Test

The AC leakage from any exposed metal part to earth ground and from all exposed metal parts to any exposed metal part having a return to chassis, must not exceed 0.5 mA (500 microamperes). Leakage current can be measured by any one of three methods.

1. A commercial leakage tester, such as the Simpson 229 or RCA WT-540A. Follow the manufacturers' instructions to use these instructions.
2. A battery-operated AC milliampmeter. The Data Precision 245 digital multimeter is suitable for this job.
3. Measuring the voltage drop across a resistor by means of a VOM or battery-operated AC voltmeter. The “limit” indication is 0.75 V, so analog meters must have an accurate low voltage scale. The Simpson's 250 and Sanwa SH-63TRD are examples of passive VOMs that are suitable. Nearly all battery-operated digital multimeters that have a 2 VAC range are suitable (see Figure A).

How to Find a Good Earth Ground

A cold-water pipe is a guaranteed earth ground; the cover-plate retaining screw on most AC outlet boxes is also at earth ground. If the retaining screw is to be used as your earth ground, verify that it is at ground by measuring the resistance between it and a cold-water pipe with an ohmmeter. The reading should be zero ohms.

If a cold-water pipe is not accessible, connect a 60- to 100-watt trouble-light (not a neon lamp) between the hot side of the receptacle and the retaining screw. Try both slots, if necessary, to locate the hot side on the line; the lamp should light at normal brilliance if the screw is at ground potential (see Figure B).

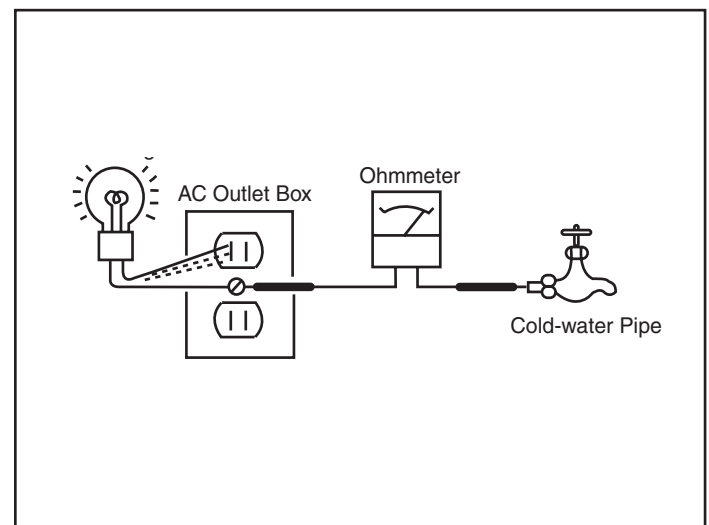

Figure B. Checking for earth ground.

SELF-DIAGNOSTIC FUNCTION



The units in this manual contain a self-diagnostic function. If an error occurs, the STANDBY/TIMER LED will automatically begin to flash. The number of times the LED flashes translates to a probable source of the problem. A definition of the STANDBY/TIMER LED flash indicators is listed in the instruction manual for the user's knowledge and reference. If an error symptom cannot be reproduced, the Remote Commander can be used to review the failure occurrence data stored in memory to reveal past problems and how often these problems occur.

Diagnostic Test Indicators

When an error occurs, the STANDBY/TIMER LED will flash a set number of times to indicate the possible cause of the problem. If there is more than one error, the LED will identify the first of the problem areas.

Results for all of the following diagnostic items are displayed on screen. If the screen displays a "0", an error has occurred.

Diagnostic Item	No. of times STANDBY / TIMER lamp flashes	Probable Cause Location	Detected Symptoms
Power does not turn on	Does not light	<ul style="list-style-type: none"> Power cord is not plugged in. Fuse is burned out (F601). (GK Board) 	<ul style="list-style-type: none"> Power does not come on. No power is supplied to the TV. AC Power supply is faulty.
+B overcurrent (OCP)*	2 times	<ul style="list-style-type: none"> H.OUT (Q502) is shorted. (A Board) IC702 is shorted. (C Board) 	<ul style="list-style-type: none"> Power does not come on. Load on power line shorted.
+B overvoltage (OVP)	3 times	<ul style="list-style-type: none"> IC501 is faulty. (A Board) If a high is supplied to pin 2 of IC501. (A Board) 	<ul style="list-style-type: none"> Has entered standby mode.
I-Prot	4 times	<ul style="list-style-type: none"> +12V is not supplied. (A Board) IC561 is faulty. (A Board) 	<ul style="list-style-type: none"> Has entered standby state after horizontal raster. Vertical deflection pulse is stopped. Power line is shorted or power supply is stopped.
IK (AKB)	5 times	<ul style="list-style-type: none"> Video OUT (IC561) is faulty. (A Board) IC702 is faulty. (C Board) Screen (G2) is improperly adjusted. ** 	<ul style="list-style-type: none"> No raster is generated. CRT Cathode current detection reference pulse output is small.
Zero Cross	9 times	<ul style="list-style-type: none"> No zero cross pulses on pin 45 IC1001. (A Board) 	<ul style="list-style-type: none"> Power does not come on.
9V Check	10 times	<ul style="list-style-type: none"> Relay failed (RY600) 	<ul style="list-style-type: none"> Power does not come on.

* If a +B overcurrent is detected, stoppage of the vertical deflection is detected simultaneously. The symptom that is diagnosed first by the microcontroller is displayed on the screen.

** Refer to Screen (G2) Adjustments in Section 2-4 of this manual

Display of Standby/Timer LED Flash Count

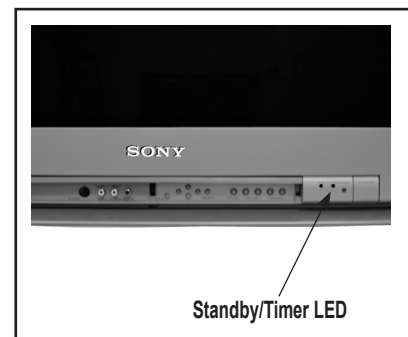
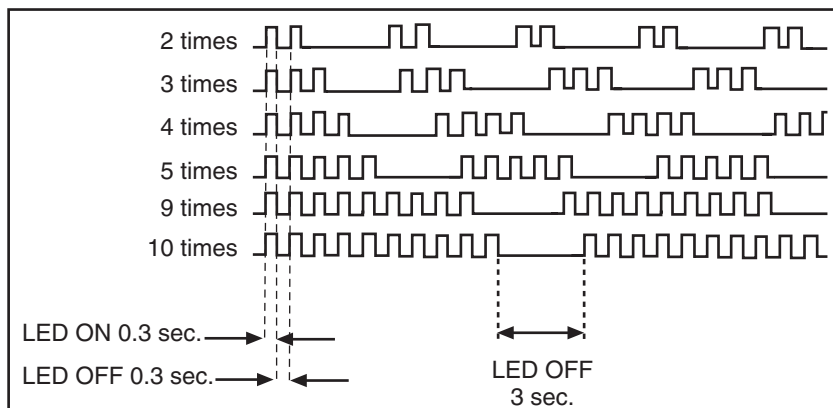

Diagnostic Item	Flash Count*
+B Overcurrent	2 times
+B Overvoltage	3 times
V-STOP	4 times
IK (AKB)	5 times
Zero Cross	9 times
9V	10 times

*One flash count is not used for self-diagnostic.

Stopping the Standby/Timer LED Flash

Turn off the power switch on the TV main unit or unplug the power cord from the outlet to stop the STANDBY/TIMER LAMP from flashing.

Self-Diagnostic Screen Display

For errors with symptoms such as "power sometimes shuts off" or "screen sometimes goes out" that cannot be confirmed, it is possible to bring up past occurrences of failure on the screen for confirmation.

To Bring Up Screen Test

In standby mode, press buttons on the Remote Commander sequentially, in rapid succession, as shown below:

DISPLAY → Channel **5** → Sound volume **0** → Power ON.

SELF DIAGNOSIS	
2: +B OCP	0
3: +B OVP	0
4: VSTOP	0
5: AKB	1
9: ZCD	0
10: 9VON	0
101: WDT	0
Serial: xxxxxxx	
Model: xxxxxxx	

Numeral "0" means that no fault was detected.

Numeral "1" means a fault was detected one time only.

Handling of Self-Diagnostic Screen Display

Since the diagnostic results displayed on the screen are not automatically cleared, always check the self-diagnostic screen during repairs. When you have completed the repairs, clear the result display to "0".

Unless the result display is cleared to "0", the self-diagnostic function will not be able to detect subsequent faults after completion of the repairs.

Clearing the Result Display

To clear the result display to "0", press buttons on the Remote Commander sequentially when the diagnostic screen is displayed, as shown below:

Channel **8** → **ENTER**

Quitting the Self-Diagnostic Screen

To quit the entire self-diagnostic screen, turn off the power switch on the Remote Commander or the main unit.

Self-Diagnostic Circuit

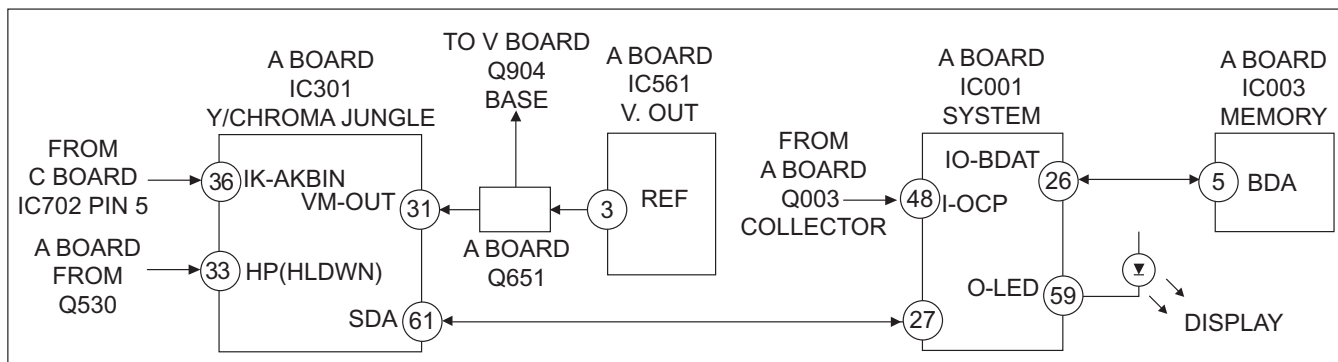

+B overcurrent (OCP)

Occurs when an overcurrent on the +B (135V) line is detected by pin 48 of IC001 (A Board). If the voltage of pin 48 of IC001 (A Board) is less than 1V when V.SYNC is more than seven verticals in a period, the unit will automatically turn off.

+B overvoltage (OVP)

Occurs when a high is felt on pin 2 of IC501 (A Board).

I-PROT

Occurs when an absence of the vertical deflection pulse is detected by pin 31 of IC301 (A Board). Power supply will shut down when waveform interval exceeds 2 seconds.

IK (AKB)

If the RGB levels* do not balance within 2 seconds after the power is turned on, this error will be detected by IC301 (A Board). TV will stay on, but there will be no picture.

*(Refers to the RGB levels of the AKB detection Ref pulse that detects 1K).

Zero Cross

Check Q691 collector (GK Board) 7.5V STBY goes to 0V when the set is turned on.

9V Check

Check Q691 collector (GK Board) 7.5V STBY goes to 0V when the set is turned on.

SECTION 1: DISASSEMBLY

1-1. REAR COVER REMOVAL

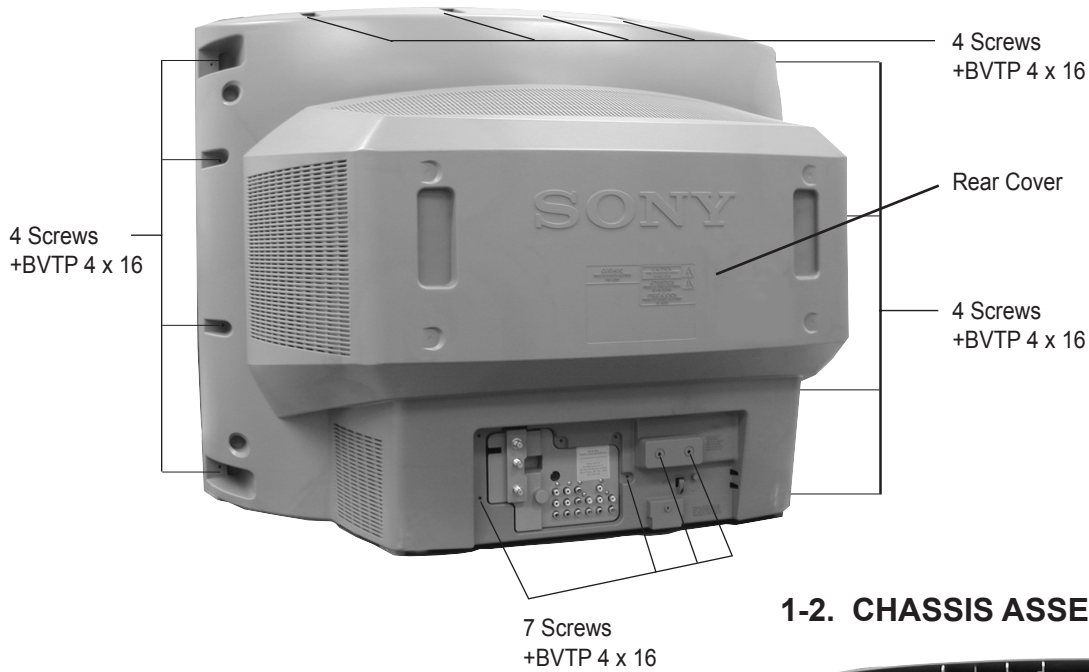

1-2. CHASSIS ASSEMBLY REMOVAL

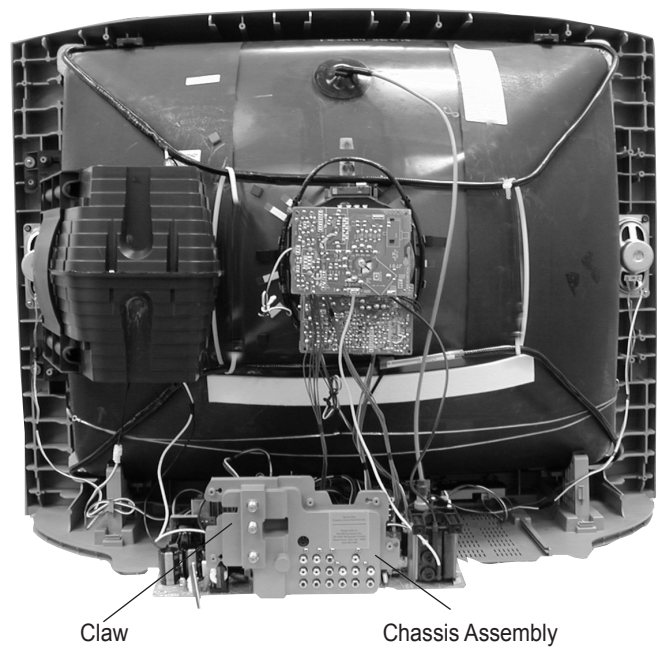

1-3. SERVICE POSITION

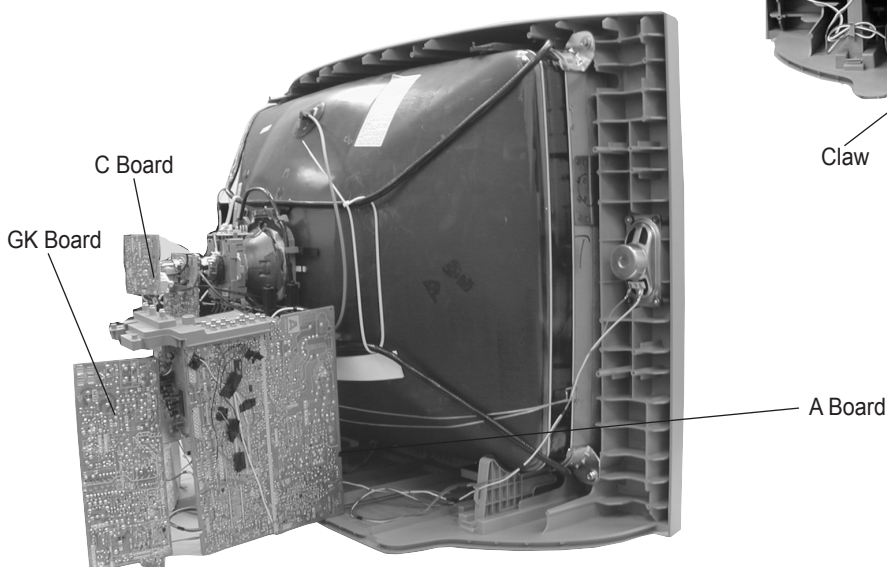

1-4. PICTURE TUBE REMOVAL

WARNING: BEFORE REMOVING THE ANODE CAP

High voltage remains in the CRT even after the power is disconnected. To avoid electric shock, discharge CRT before attempting to remove the anode cap. Short between anode and CRT coated earth ground strap.

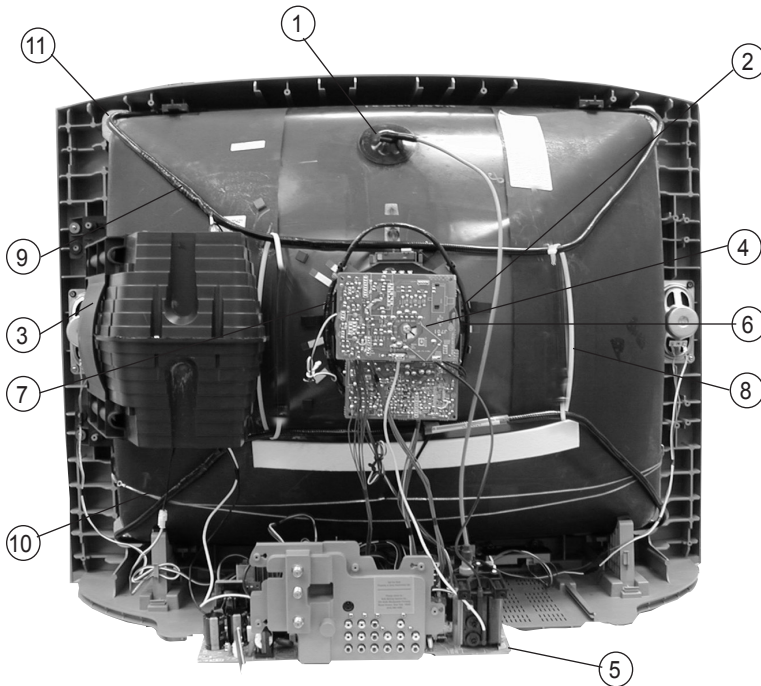
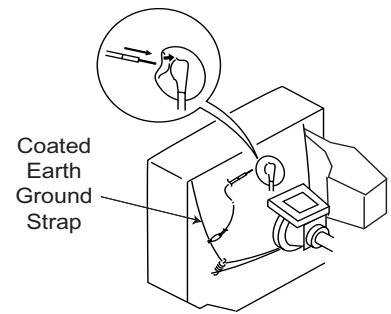

1. Discharge the anode of the CRT and remove the anode cap.
2. Unplug all interconnecting leads from the deflection yoke, neck assembly, degaussing coils and CRT grounding strap.
3. Remove the Sub-Woofer Assemblies.
4. Remove the C Board from the CRT.
5. Remove the chassis assembly.
6. Loosen the neck assembly fixing screw and remove.
7. Loosen the deflection yoke fixing screw and remove.
8. Place the set with the CRT face down on a cushion and remove the degaussing coil holders.
9. Remove the degaussing coils.
10. Remove the CRT grounding strap and spring tension devices.
11. Unscrew the four CRT fixing screws [located on each CRT corner] and remove the CRT [Take care not to handle the CRT by the neck].

ANODE CAP REMOVAL PROCEDURE

WARNING: High voltage remains in the CRT even after the power is disconnected. To avoid electric shock, discharge CRT before attempting to remove the anode cap. After removing the anode cap, short circuit to either the metal chassis, CRT shield, or carbon painted on the CRT.

NOTE: After removing the anode cap, short circuit the anode of the picture tube and the anode cap to either the metal chassis, CRT shield or carbon painted on the CRT.

REMOVAL PROCEDURES

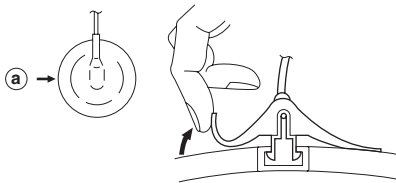

Turn up one side of the rubber cap in the direction indicated by arrow a .

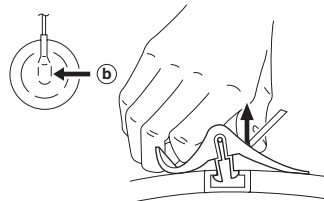

Use your thumb to pull the rubber cap firmly in the direction indicated by arrow b .

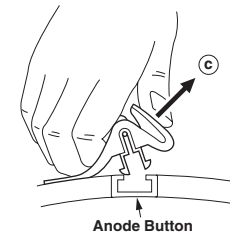

When one side of the rubber cap separates from the anode button, the anode cap can be removed by turning the rubber cap and pulling it in the direction of arrow c .

HOW TO HANDLE AN ANODE CAP

1. Do not use sharp objects which may cause damage to the surface of the anode cap.
2. To avoid damaging the anode cap, do not squeeze the rubber covering too hard. A material fitting called a shatter-hook terminal is built into the rubber.
3. Do not force turn the foot of the rubber cover. This may cause the shatter-hook terminal to protrude and damage the rubber.

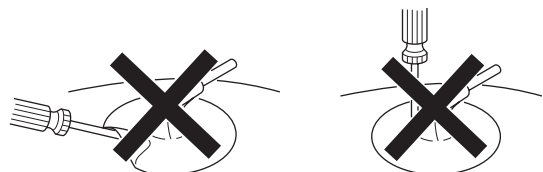

SECTION 2: SET-UP ADJUSTMENTS

The following adjustments should be made when a complete realignment is required or a new picture tube is installed. These adjustments should be performed with rated power supply voltage unless otherwise noted.

The controls and switch should be set as follows unless otherwise noted:

PICTURE CONTROL: normal
BRIGHTNESS CONTROL: normal

Perform the adjustments in order as follows:

1. Beam Landing
2. Convergence
3. Focus
4. Screen (G2)/White Balance

Test Equipment Required:

1. Color Bar Pattern Generator
2. Degausser
3. DC Power Supply
4. Digital Multimeter
5. Oscilloscope
6. CRT Analyzer

2-1. BEAM LANDING

Preparation:

- Input a white pattern signal.
- Face the picture tube in an East or West direction to reduce the influence of geomagnetism.

NOTE: Do not use the hand degausser; it magnetizes the CRT .

1. Input white pattern from pattern generator.
2. Loosen the deflection yoke mounting screw, and set the purity control to the center as shown below:

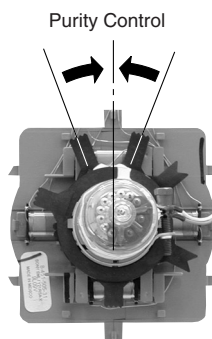

3. Input green pattern from pattern generator.
4. Move the deflection yoke backward, and adjust with the purity control so that green is in the center and red and blue are even on both sides.

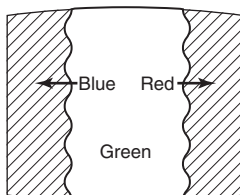

5. Move the deflection yoke forward, and adjust so that the entire screen becomes green.

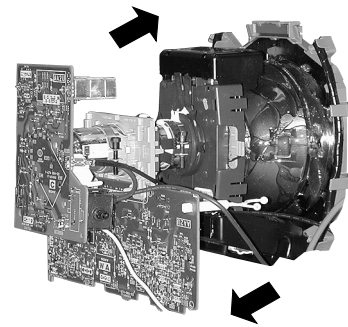

6. Switch over the raster signal to red and blue and confirm the condition.
7. When the position of the deflection yoke is determined, tighten it with the deflection yoke mounting screw.
8. When landing at the corner is not right, adjust by using the disk magnets.

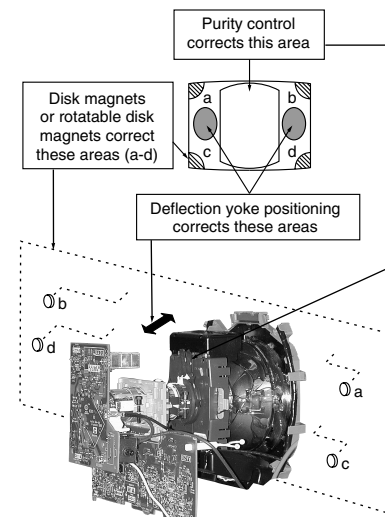

2-2. CONVERGENCE

Preparation:

- Perform FOCUS, V. LIN and V. SIZE adjustments.
- Set BRIGHTNESS control to minimum.
- Input dot pattern.

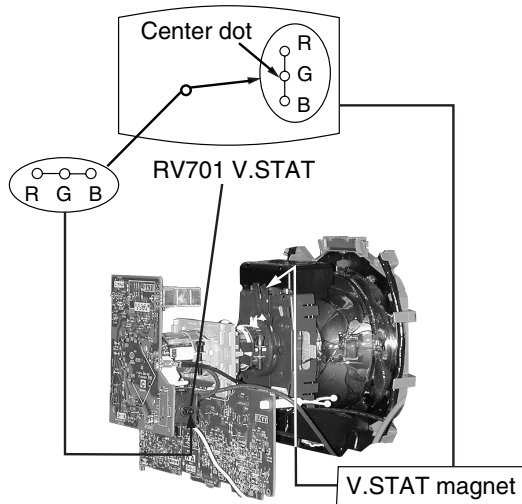

VERTICAL AND HORIZONTAL STATIC CONVERGENCE

1. Adjust V. STAT magnet to converge red, green and blue dots in the center of the screen (Vertical movement).

Tilt the V. STAT magnet and adjust static convergence to open or close the V. STAT magnet.

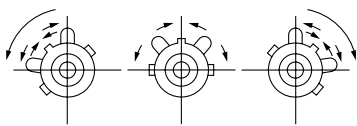

2. When the V. STAT magnet is moved in the direction of arrow a and b, red, green, and blue dots move as shown below:

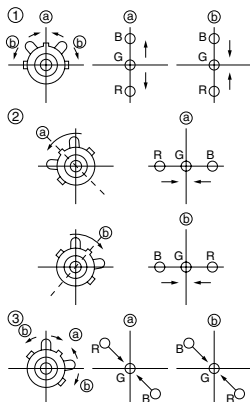

OPERATION OF BMC (HEXAPOLE) MAGNET

The respective dot positions resulting from moving each magnet interact, so perform adjustment while tracking.

- 1 Use the V.STAT tabs to adjust the red, green, and blue dots so they line up at the center of the screen (move the dots in a horizontal direction).

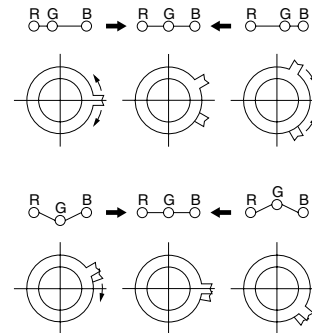

Y SEPARATION AXIS CORRECTION MAGNET ADJUSTMENT

1. Input cross-hatch pattern, adjust PICTURE to minimum and BRIGHTNESS to normal.
2. Adjust the deflection yoke upright so it touches the CRT.
3. Adjust so that the Y separation axis correction magnet on the neck assembly is symmetrical from top to bottom (open state).

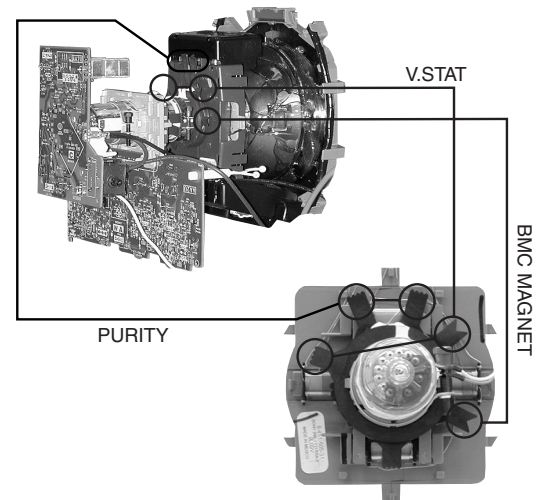

4. Return the deflection yoke to its original position.

DYNAMIC CONVERGENCE ADJUSTMENT

Before starting, perform Vertical and Horizontal Static Convergence Adjustment.

1. Slightly loosen deflection yoke screw.
2. Remove deflection yoke spacers.
3. Move the deflection yoke for best convergence as shown below:

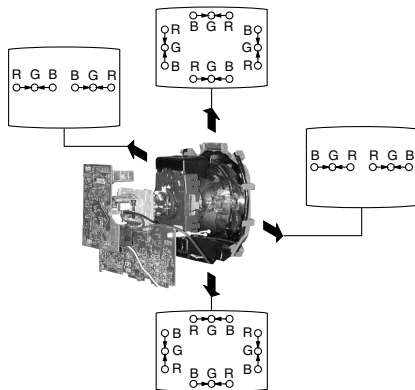

4. Tighten the deflection yoke screw.
5. Install the deflection yoke spacers.

SCREEN-CORNER CONVERGENCE

1. Affix a permalloy assembly corresponding to the misconverged areas:

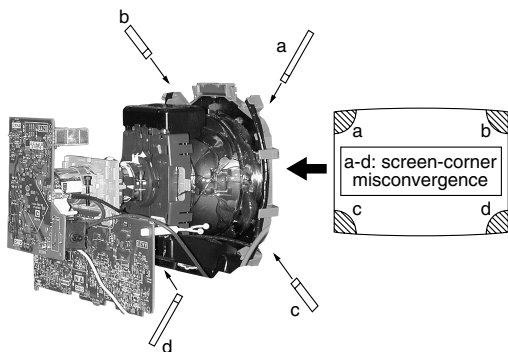

TLH PLATE ADJUSTMENT

Preparation:

- Input crosshatch pattern.
- Adjust Picture Quality to standard, Picture and Brightness to 50%, and Other to standard.
- Adjust the Horizontal Convergence of red and blue dots by tilting the TLH plate on the deflection yoke.

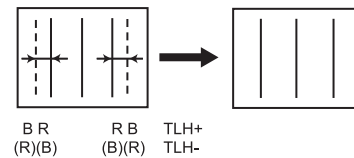
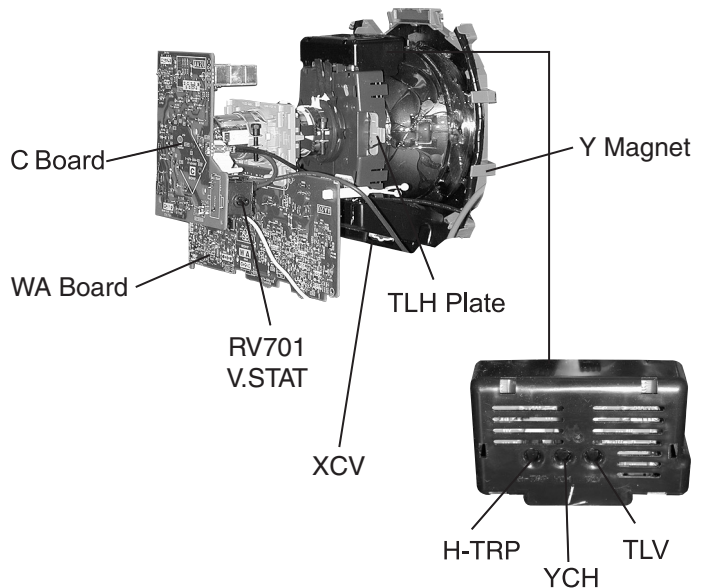

1. Adjust XCV core to balance X axis.
2. Adjust YCH VR to balance Y axis.
3. Adjust vertical red and blue convergence with V.TILT (TLV VR.) Perform adjustments while tracking items 1 and 2.
4. Adjust Y MAGNET to correct V.BOW Geometry Distortion.
5. Adjust H-TRP to correct H.Trapezoid Geometry Distortion.

After adjusting items 4 and 5, confirm overall geometry again.

2-3. FOCUS

1. Input monoscope signal.
2. Set user controls to normal.
3. Set video mode to STANDARD.
4. Set the PICTURE to maximum.
5. Adjust at 325 Mark for best center/corner focus balance.
6. Receive an entire white signal. Make sure Magenta Ring is at an acceptable level.

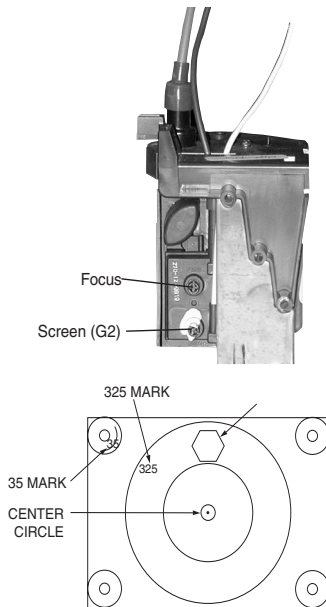

2-4. SCREEN (G2)

1. Input dot pattern from the pattern generator.
2. Set the user controls to NORMAL.
3. Attach the G2-Jig to the C Board.
4. Adjust RCUT, GCUT, BCUT, and SBRT in service mode with an oscilloscope so that voltages on the red, green, and blue cathodes are $170 \pm 2.0\text{Vdc}$.
5. Observe the screen and adjust SCREEN (G2) VR to obtain the faintly visible background of dot signal.
6. Push the TEST + JUMP (+ Channel) to cut off the signal. The screen should be bright or dark. Brightness of raster must be increased when adjusting.
7. Adjust screen VR until the screen is slightly cut off, or scarcely lights up. A signal cannot be seen when the brightness of the raster is high.
8. Push the JUMP again to release the cut off.

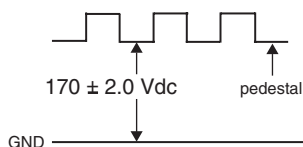

2-5. WHITE BALANCE ADJUSTMENTS

Adj.	NO.	Disp.	Item	All Models
VID_ADJ	0	RDRV	Red Drive	41
VID_ADJ	1	GDRV	Green Drive	32
VID_ADJ	2	BDRV	Blue Drive	29
VID_ADJ	3	RCUT	Red Cut-off	31
VID_ADJ	4	GCUT	Green Cut-off	14
VID_ADJ	5	BCUT	Blue Cut-off	17
VP2	4	SBRT	Sub Bright	16

1. Set program palette to STANDARD and push RESET.
2. Input an entire white signal.
3. Set to Service Adjustment Mode.
4. Set the PICTURE and BRIGHT to minimum.
5. Adjust with SBRT if necessary.
6. Set RCUT to "14".
7. Select GCUT and BCUT with **[3]** and **[5]**.
8. Adjust by pressing **[1]** and **[4]** for the best white balance.
9. Set the PICTURE and BRIGHT to maximum.
10. Select GDRV and BDRV with **[1]** and **[2]**.
11. Adjust with **[3]** and **[6]** for the best white balance.
12. Write into the memory by pressing **[3]** then **[5]**.
13. Repeat steps 1-12 for GDR4, BDR4, GCU4 and BCU4 using Video 4 input.



* Use values from Sub Contrast Adjustments

White balance should be adjusted after Sub Contrast because RDRV is also used in Sub Contrast Adjustment. (See page 22).

SECTION 3: SAFETY RELATED ADJUSTMENTS

3-1. R530, R531 CONFIRMATION METHOD (HOLD-DOWN CONFIRMATION) AND READJUSTMENTS

Always perform the following adjustments when replacing the following components marked with a  mark on the schematic diagram:

Part Replaced ()	Adjustment ()
A BOARD: R550, T503, T504, D519, IC501, R533, D521, R532, D520, C531, R529, R530, R531, C532	HV HOLD DOWN R530, R531

PREPARATION BEFORE CONFIRMATION

- Using a Variac, apply AC input voltage: 120+2.0 VAC.
- Turn the POWER switch ON.
- Input a white signal and set the PICTURE and BRIGHT controls to maximum.
- Confirm that the voltage of more than 23.0 VDC appears between TP85 and ground on the A Board.

HOLD-DOWN OPERATION CONFIRMATION

- Connect the current meter between Pin 11 of the FBT (T503) and the PWB land where Pin 11 would normally attach. (See Figure 1).
- Input a dot signal and set PICTURE and BRIGHTNESS to minimum: IABL = 2175 + 100/ -325 μ A.
- Confirm the voltage of A Board TP91 is 135 \pm 1.5 VDC.
- Connect the digital voltmeter and the DC power supply to TP85 and ground. (See Figure 1 above).
- Increase the DC power voltage gradually until the picture blanks out.
- Turn DC power source off immediately.
- Read the digital voltmeter indication (standard = 27.24 + 0.0/ - 0.1 VDC).
- Input a white signal and set PICTURE and BRIGHTNESS to maximum: IABL = 2175 + 100/ -325 μ A.
- Repeat steps 4 to 7.

HOLD-DOWN READJUSTMENT

If the setting indicated in Step 2 of Hold-Down Operation Confirmation cannot be met, readjustment should be performed by altering the resistance value of R530, R531 component marked with .

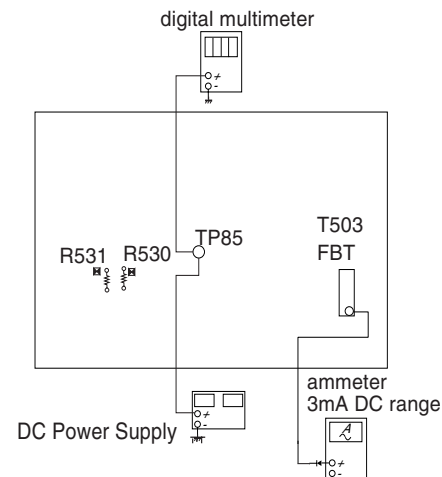



Figure 1

3-2. B+ VOLTAGE CONFIRMATION AND ADJUSTMENT

Always perform the following adjustments when replacing the following components, which are marked with  on the schematic diagram on the GK Board:

GK BOARD: IC600, PH602

- Using a Variac, apply AC input voltage: 130 + 2.0/-0.0 VAC
- Input a monoscope signal.
- Set the PICTURE control and the BRIGHT control to minimum.
- Confirm the voltage on A Board between TP23 and ground is less than 136.5 VDC.
- If step 4 is not satisfied, replace R530 and R531 on A Board and repeat the above steps.

SECTION 4: CIRCUIT ADJUSTMENTS

ELECTRICAL ADJUSTMENTS BY REMOTE COMMANDER

Use the Remote Commander (RM-Y181, RM-Y182) to perform the circuit adjustments in this section.

Test Equipment Required: 1. Pattern generator 2. Frequency counter 3. Digital multimeter 4. Audio oscillator

4-1. SETTING SERVICE ADJUSTMENT MODE

- Standby mode (Power off).
- Press the following buttons on the remote commander within a second of each other:

DISPLAY → Channel **5** → Sound Volume **+** → Power

SERVICE ADJUSTMENT MODE IN

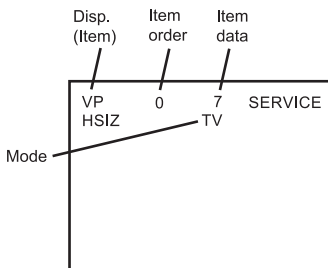

- The CRT displays the item being adjusted.
- Press **1** or **2** on the Remote Commander to select the item.
- Press **3** or **6** on the Remote Commander to change the data.
- Press **MUTING** then **ENTER** to write into memory.

SERVICE ADJUSTMENT MODE MEMORY

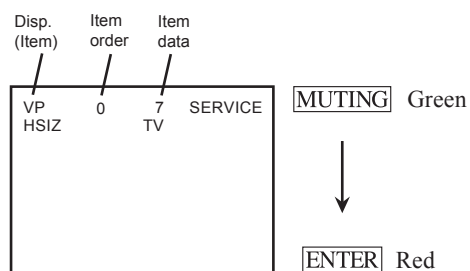

- Press then on the Remote Commander to initialize.

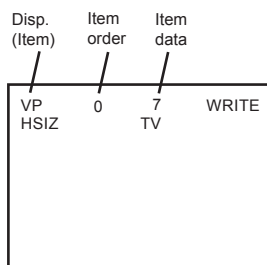

- DO NOT turn off set until **SERVICE** appears.

4-2. MEMORY WRITE CONFIRMATION METHOD

- After adjustment, pull out the plug from the AC outlet, then replace the plug in the AC outlet again.
- Turn the power switch ON and set to Service Mode.
- Call the adjusted items again to confirm they were adjusted.

4-3. REMOTE ADJUSTMENT BUTTONS AND INDICATORS

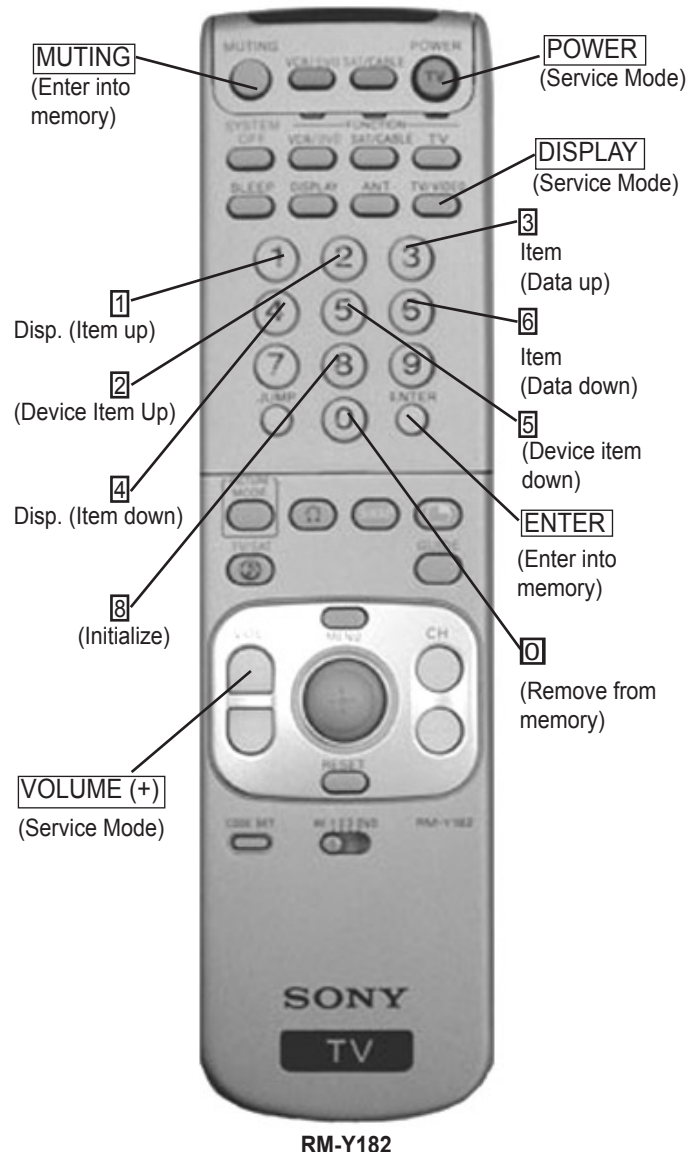

RM-Y182

4-4. SERVICE DATA LISTS

Non-Volatile Memory (NVM) Reference for BA5D Service List

Service Group	No.	Name	Description	Bit Mask	Common		
					Slave Addr	Sub Addr	Init Data
VERSION	0	VER	Microprocessor version information	11111111	=	=	0

Service Group	No.	Name	Fix / Var	Description	Bit Mask	Common				NTSC / PAL-M			PAL-N		
						Slave Addr	Sub Addr	Fix Data	Var Data	Slave Addr	Sub Addr	Data	Slave Addr	Sub Addr	Data
VP1	0	HSIZ	Var	H SIZE (11 / 2-7)	11111100					A4	A8		A4	B4	
	1	HPOS	Var	HPOS (12 / 2-7)	11111100					A4	A9		A4	B5	
	2	VBOW	Var	AFC BOW (16 / 4-7)	11110000					A4	AE		A4	BA	
	3	VANG	Var	AFC ANGLE (16 / 0-3)	00001111					A4	AE		A4	BA	
	4	VTRP	Var	TRAPEZIUM (20 / 3-7)	11111000					A4	AF		A4	BB	
	5	HTRP	Var	H. TRAPEZOID (15 / 4-7)	11110000					A4	AD		A4	B9	
	6	TROT	Fix	TILT ROTATION (0-63)	11111100					A4	A4		A4	B0	
	7	PAMP	Var	PIN AMP (13 / 2-7)	11111100					A4	AA		A4	B6	
	8	UPIN	Var	UP-CPIN (14 / 2-7)	11111100					A4	AB		A4	B7	
	9	LPIN	Var	LO-CPIN (1C / 2-7)	11111100					A4	AC		A4	B8	
	10	VSIZ	Var	V SIZE (0E / 2-7)	11111100					A4	A5		A4	B1	
	11	VPOS	Var	V POSITION (0E / 2-7)	11111100					A4	A6		A4	B2	
	12	VLIN	Var	V LINEARITY (10 / 0-3)	00001111					A4	A7		A4	B3	
	13	SCOR	Var	S CORRECTION (10 / 4-7)	11110000					A4	A7		A4	B3	
	14	VZOM	Fix	16:9 CRT Z Mode on/off	10000000	A4	85								
	15	EHT	Fix	Vertical High-Voltage Compensation	00001111	A4	80								
	16	ASP	Fix	Aspect Ratio control (4:3 Mode)	11111100	A4	FB	47							
	17	ASP1	Fix	Aspect Ratio control (16:9 Mode)	11111100	A4	FC	47							
	18	SCRL	Fix	16:9 CRT Z Mode Trans. Scroll	00111111	A4	86								
	19	HBLK	Fix	Horizontal Blanking on/off	00010000	A4	85								
	20	LBLK	Fix	Left Blanking Adjustment	11110000	A4	80								
	21	RBLK	Fix	Rigth Blanking Adjustment	00001111	A4	81								
	22	HDW	Fix	Horizontal Drive Pulse Width	00001000	A4	85								
	23	EWDC	Fix	"Parabola" EW, D.C. Adjustment	00000100	A4	88								
	24	LVLN	Fix	Lower Screen BTM Vertical Line Adj.	11110000	A4	81								
	25	UVLN	Fix	Uppe Screen BTM Vertical Line Adj.	00001111	A4	82								
	26	INTL	Fix	INTERLACE	00110000	A4	84								
	27	HOSC	Fix	Horizontal VCO Oscillation Freq.	11110000	A4	82								
	28	VSS	Fix	Vertical Sync Slice Level	11000000	A4	84								
	29	HSS	Fix	Horizontal Sync Slice Level	00001000	A4	88								
	30	HMSK	Fix	For Macro Vision	00010000	A4	88								
	31	VTMS	Fix	Select Signal VTIM Pin	01100000	A4	85								
	32	TCMD	Fix	Vertical Count Down Mode Switching (for TV)	00000011	A4	8C								
	33	VCMD	Fix	Vertical Count Down Mode Switching (for Video)	00000011	A4	8D								
	34	AFC	Fix	AFC Loop Gain Switching	11000000	A4	86								
	35	FIFR	Fix	Field Frequency	11000000	A4	87								
	36	VBLK	Fix	VBLKW	00000011	A4	88								
37	HTSW	Fix	H-Trap Switch : NEW	00100000	A4	88									

SERVICE DATA LISTS

Service Group	No.	Name	Fix / Var	Description	Bit Mask	Common				NTSC			PAL-M			PAL-N		
						Slave Addr	Sub Addr	Fix Data	Var Data	Slave Addr	Sub Addr	Data	Slave Addr	Sub Addr	Data	Slave Addr	Sub Addr	Data
VP2	0	REFP	Fix	REFP	01000000	A4	88	0										
	1	JPSW	Fix	Jump SW	00000001	=	=											
	2	SHUE	Var	Sub HUE adjustment	11110000	A4	8C											
	3	SCOL	Var	Sub COLOR adjustment	00001111					A4	8E		A4	90	7	A4	92	
	4	SBRT	Var	Sub BRIGHTNESS adjustment	00011111	A4	87											
	5	AXPL	Fix	Axis PAL	00000001	A4	89	0										
	6	AXNT	Fix	Axis NTSC	00000010	A4	89	1										
	7	CBPF	Fix	Chroma BPF on/off	00000100	A4	89	1										
	8	CTRP	Fix	Y TRAP FILTER on/off	00000001	=	=											
	9	COFF	Fix	Color On/off	00000010	=	=											
	10	KOFF	Fix	Set Color Killer	00100000	A4	89	0										
	11	SSHP	Fix	Sub SHARPNESS	11110000	A4	83											
	12	TSPF	Fix	SHARPNESS Circuit Fo (for TV)	00001100	A4	8C											
	13	VSPF	Fix	SHARPNESS Circuit Fo (for Video)	00001100	A4	8D											
	14	PREL	Fix	Pre-Shoot/ Over-Shoot	01000000	A4	89	1										
	15	ABLM	Fix	ABL Mode Switch	10000000	A4	89	1										
	16	VTH	Fix	ABL CD VHT Switching	00000001	=	=											
	17	YDEL	Fix	Y Delay Time Control	00001111	A4	84											
	18	NCOL	Fix	No Color ID	00000001	A4	85											
	19	FSC	Fix	FSC Out on/off	00000010	A4	85	1										
20	KID	Fix	Killer ID Control on/off	00000100	A4	85	0											

Service Group	No.	Name	Fix / Var	Description	Bit Mask	Common				NTSC			PAL-M			PAL-N		
						Slave Addr	Sub Addr	Fix Data	Var Data	Slave Addr	Sub Addr	Data	Slave Addr	Sub Addr	Data	Slave Addr	Sub Addr	Data
VID_ADJ	0	RDRV	var	R DRIVE (0A / 7-2)	11111100	A4	9E	41										
	1	GDRV	Var	G DRIVE (0B / 7-2)	11111100	A4	9F											
	2	BDRV	Var	B DRIVE (0C / 7-2)	11111100	A4	A0											
	3	RCUT	Var	R CUT OFF (07 / 7-2)	11111100	A4	A1	31										
	4	GCUT	Var	G CUT OFF (08 / 7-2)	11111100	A4	A2											
	5	BCUT	Var	B CUT OFF (09 / 7-2)	11111100	A4	A3											
	6	SCON	Var	Sub Contrast adjustment	00001111	A4	8A											
	7	CHUE	Var	Sub HUE adjustment for TV	00011111	A4	94	16										
	8	CCOL	Var	Sub COLOR adjustment for TV	00011111					A4	8F	18	A4	91	18	A4	93	23
	9	UOFS	Var	YUV U offset	00001111	A4	8B											
	10	VOFS	Var	YUV V offset	11110000	A4	8B											
	11	RON	Fix	R ON (01 / 3)	00001000	=	=											
	12	GON	Fix	G ON (01 / 2)	00000100	=	=											
	13	BON	Fix	B ON (01 / 1)	00000010	=	=											
	14	HUEV	Var	Sub HUE adjustment for Video	11110000	A4	8D											
15	COLV	Var	Sub COLOR adjustment for Video	11110000					A4	8E		A4	90		A4	92		

SERVICE DATA LISTS

Service Group	No.	Name	Fix / Var	Description	Bit Mask	Common		
						Slave Addr	Sub Addr	Fix Data
COL_TMP	0	GDOF	Fix	G DRIVE Offset	11111000	A4	9A	4
	1	BDOF	Fix	B DRIVE Offset	11111000	A4	9B	15
	2	GCOF	Fix	G CUT Offset	11111000	A4	9C	7
	3	BCOF	Fix	B CUT Offset	11111000	A4	9D	14
	4	DCOL	Fix	Dinamic Color	00000010	=	=	

Service Group	No.	Name	Fix / Var	Description	Bit Mask	Common		
						Slave Addr	Sub Addr	Fix Data
PIC_IMP	0	BLAD	Fix	Black area detect (01 / 6-7)	11000000	A4	09	0
	1	SRTS	Fix	SRT level (01 / 4-5)	00110000	A4	09	3
	2	YNR	Fix	YNR(01 / 2)	00000100	A4	09	1
	3	GIRE	Fix	Gamma correction(01 / 0-1)	00000011	A4	09	3
	4	DAC1	Fix	DAC1(02 / 7)	10000000	A4	0A	0
	5	DAC2	Fix	DAC2(02 / 6)	01000000	A4	0A	0
	6	VMGA	Fix	VM on 1226 (02/5-4)	00110000	A4	0A	0
	7	GCUR	Fix	Gamma curve(02 / 2)	00000100	A4	0A	1
	8	BLKC	Fix	Black Compensation (02 / 1)	00000010	A4	0A	1
	9	TEST	Fix	TEST(03 / 6-7)	11000000	A4	0B	3
	10	RS	Fix	RS (03 / 3-5)	00111000	A4	0B	0
	11	RTC	Fix	RTC(03 / 0-2)	00000111	A4	0B	2
	12	APAC	Fix	APAC	10000000	A4	0B	0
	13	SRTH	Fix	SRT bit for Dynablack = High	10000000	A4	5C	1
	14	SRTL	Fix	SRT bit for Dynablack = Low	10000000	A4	5D	1
	15	SRTO	Fix	SRT bit for Dynablack = Off	10000000	A4	5E	0
	16	SHPH	Fix	Sharpness level for Dynablack = High	01111111	A4	5C	54
	17	SHPL	Fix	Sharpness level for Dynablack = Low	01111111	A4	5D	43
18	SHPO	Fix	Sharpness level for Dynablack = Off	01111111	A4	5E	0	

Service Group	No.	Name	Fix / Var	Description	Bit Mask	Palette = VIVID			Palette = STANDARD			Palette = MOVIE			Palette = SPORTS		
						Slave Addr	Sub Addr	Fix Data	Slave Addr	Sub Addr	Fix Data	Slave Addr	Sub Addr	Fix Data	Slave Addr	Sub Addr	Fix Data
PALETTE	0	VPIC	Fix	User picture setting 0:min, 63: max	11111100	A4	5F	63	A4	65	50	A4	6B	38	A4	71	63
	1	VBRT	Fix	User brightness setting 0:min, 63: max	11111100	A4	60	31	A4	66	31	A4	6C	31	A4	72	31
	2	VCOL	Fix	User color setting 0:min, 63: max	11111100	A4	61	35	A4	67	31	A4	6D	31	A4	73	40
	3	VSHP	Fix	User sharpness setting 0:min, 63: max	11111100	A4	62	31	A4	68	31	A4	6E	34	A4	74	31
	4	VVM	Fix	0: OFF, 1: Low, 2: High, 3: N/A	00000011	A4	5F	2	A4	65	1	A4	6B	0	A4	71	2
	5	VTRI	Fix	0: Cool, 1: Nutral, 2: Warm, 3: N/A	00000011	A4	60	0	A4	66	1	A4	6C	2	A4	72	0
	6	VGMA	Fix	0: OFF, 1: Low, 2: Mid, 3: Max	00000011	A4	63	2	A4	69	2	A4	6F	2	A4	75	2
	7	VNRM	Fix	0: 3D, 1: 2D	00000010	A4	61	0	A4	67	0	A4	6D	0	A4	73	0
	8	VYDC	Fix	DC Transmission Ratio 0,1: 100%, 2: 92%, 3: 85	00000011	A4	62	3	A4	68	3	A4	6E	2	A4	74	3
	9	VVEN	Fix	Vertoca; Enhancement	00011100	A4	63	5	A4	69	3	A4	6F	3	A4	75	5
	10	VHK0	Fix	Horizontal Peaking 0:On, 1:Off	00000001	A4	61	0	A4	67	0	A4	6D	0	A4	73	0
	11	VDBK	Fix	User Dynablack 0: OFF, 1: Low, 2: High, 3: N/A	01100000	A4	63	2	A4	69	1	A4	6F	1	A4	75	1
12	VYPL	Fix	Y-Peaking Limit	00000011	A4	64	1	A4	6A	0	A4	70	0	A4	76	1	

SERVICE DATA LISTS

Service Group	No.	Name	Fix / Var	Description	Bit Mask	Common		
						Slave Addr	Sub Addr	Fix Data
3L_COMB	0	FUNN	Fix	Function (0 / 7-6) for NTSC	11000000	A4	3C	3
	1	FUNP	Fix	Function (0 / 7-6) for PAL-N, PAL-M	00110000	A5	3C	3
	2	DRNG	Fix	DRANG (0 / 2)	00000100	A4	3C	0
	3	YCSM	Fix	Y/C Sep Mode (0 / 1-0)	00000011	A4	3C	0
	4	CNRK	Fix	CNRK (1 / 7-6)	11000000	A4	3D	1
	5	CNRL	Fix	CNR Lim (1 / 5-4)	00110000	A4	3D	1
	6	CLPF	Fix	C-LPF(1 / 3)	00001000	A4	3D	1
	7	SLPF	Fix	SelC-LPF(1 / 2)	00000100	A4	3D	0
	8	MODE	Fix	Mode1 (1 / 1)	00000010	A4	3D	0
	9	YPG	Fix	Y - Peaking Gain (2 / 7-6)	11000000	A4	3E	3
	10	PDSC	Fix	Pds. Clip (2 / 3)	00001000	A4	3E	0
	11	YLPF	Fix	Y-LPF(2 / 2)	00000100	A4	3E	1
	12	VENL	Fix	V-Emph N.L (3 / 4-2)	00011100	A4	3F	4
13	VEC	Fix	V - Emph Core (3 / 1-0)	00000011	A4	3F	3	

Service Group	No.	Name	Fix / Var	Description	Bit Mask	Common		
						Slave Addr	Sub Addr	Fix Data
3D_COMB	0	COUT	Fix	COUTS(00 / 2-3)	00001100	A4	21	3
	1	YAPS	Fix	YAPS(00 / 0-1)	00000011	A4	21	1
	2	NSDS	Fix	NSDS(01 / 4-5)	00110000	A4	22	0
	3	MSS	Fix	MSS(01 / 2-3)	00001100	A4	22	0
	4	KILS	Fix	KILS (01 / 1-0)	00000011	A4	22	1
	5	DYC	Fix	DYCOS (02 / 7-6)	11000000	A4	23	2
	6	EXAD	Fix	EXADINS(02 / 5)	00100000	A4	23	0
	7	EXCS	Fix	EXCSS(02 / 1-0)	00000011	A4	23	1
	8	CPP	Fix	CPP(03 / 6)	01000000	A4	24	0
	9	HDP	Fix	HDP(03 / 3-5)	00111000	A4	24	6
	10	CDL	Fix	CDL(03 / 0-2)	00000111	A4	24	6
	11	DYCO	Fix	DYCOR(04 / 4-7)	11110000	A4	25	2
	12	DYGA	Fix	DYGAIN(04 / 0-3)	00001111	A4	25	10
	13	DCCO	Fix	DCCOR(05 / 4-7)	11110000	A4	26	2
	14	DCGA	Fix	DCGAIN(05 / 0-3)	00001111	A4	26	9
	15	YNRL	Fix	YNRLIM(06 / 4-5)	00110000	A4	27	1
	16	CNRL	Fix	CNRLIM(06 / 0-1)	00000011	A4	27	1
	17	ID1O	Fix	ID1ON(07 / 7)	10000000	A4	28	0
	18	ID1W	Fix	ID1W0A1(07 / 6)	01000000	A4	28	0
	19	ID1N	Fix	ID1W0A2(07 / 5)	00100000	A4	28	0
	20	WSC	Fix	WSC(08 / 6-7)	11000000	A4	29	1
	21	VTRH	Fix	VTRH(08 / 4-5)	00110000	A4	29	1
	22	VTRR	Fix	VTRR(08 / 2-3)	00001100	A4	29	1
	23	LDSR	Fix	LDSR(08 / 0-1)	00000011	A4	29	2
	24	WSS	Fix	WSS (09 / 7)	10000000	A4	2A	0
	25	ID1E	Fix	ID1ECON (09 / 6)	01000000	A4	2A	1
	26	TT	Fix	TT (09 / 4 -5)	00110000	A4	2A	0
	27	FELC	Fix	FELCHK (09 / 3)	00001000	A4	2A	1
	28	TH	Fix	TH (09 / 1-2)	00000110	A4	2A	0
	29	VAPG	Fix	VAPGAIN(0A / 5-7)	11100000	A4	2B	3
30	VAPI	Fix	VAPINV(0A / 0-4)	00011111	A4	2B	25	

SERVICE DATA LISTS

Service Group	No.	Name	Fix / Var	Description	Bit Mask	Common		
						Slave Addr	Sub Addr	Fix Data
3D_COMB	31	YPFT	Fix	YPFT(0B / 4-5)	00110000	A4	2C	3
	32	YPPG	Fix	YPPG(0B / 0-3)	00001111	A4	2C	8
	33	V1PS	Fix	V1PS(0C / 6-7)	11000000	A4	2D	3
	34	VEGS	Fix	VEGS(0C / 4-5)	00110000	A4	2D	2
	35	CC3N	Fix	CC3N(0C / 3)	00001000	A4	2D	0
	36	C0HS	Fix	C0HS(0C / 2)	00000100	A4	2D	0
	37	SEL2	Fix	SELD2FH(0C / 0)	00000001	A4	2D	1
	38	SEL1	Fix	SELD1FL(0D / 5)	00100000	A4	2E	1
	39	YHCO	Fix	YHCOR(10 / 6-7)	11000000	A4	31	0
	40	YHCG	Fix	YHCGAIN(10 / 5)	00100000	A4	31	1
	41	OVST	Fix	+OVST(10 / 3)	00001000	A4	31	0
	42	CSHD	Fix	CSHDT(10 / 2)	00000100	A4	31	0
	43	KCTT	Fix	KCTT(10 / 0-1)	00000011	A4	31	0
	44	SHT	Fix	SHT(11 / 7-6)	11000000	A4	32	0
	45	VCT	Fix	VCT(11 / 5)	00100000	A4	32	0
	46	CGAT	Fix	CLKGAT (11 / 4)	00010000	A4	32	0
	47	CG2D	Fix	CLK2D (11 / 3)	00001000	A4	32	1
	48	CGGT	Fix	CLKGGT (11 / 2)	00000100	A4	32	0
	49	CGEB	Fix	CLKGEB (11 / 1)	00000010	A4	32	0
	50	CGT	Fix	CLKGT (11 / 0)	00000001	A4	32	0
	51	HPLL	Fix	HPLLFS(12 / 7)	10000000	A4	33	1
	52	BPLL	Fix	BPLLFS (12 / 6)	01000000	A4	33	0
	53	FSCF	Fix	FSCFG(12 / 5)	00100000	A4	33	0
	54	PLL	Fix	PLLFG(12 / 4)	00010000	A4	33	1
	55	KILR	Fix	KILR(12 / 0-3)	00001111	A4	33	3
	56	HSSL	Fix	HSSL(13 / 4-7)	11110000	A4	34	12
	57	VSSL	Fix	VSSL(13 / 0-3)	00001111	A4	34	8
	58	BGPS	Fix	BGPS(14 / 4-7)	11110000	A4	35	4
	59	BGPW	Fix	BGPW(14 / 0-3)	00001111	A4	35	10
	60	ADCL	Fix	ADCLKS(15 / 6-7)	11000000	A4	36	3
	61	NSDW	Fix	NSDSW(15 / 4)	00010000	A4	36	1
	62	HIZE	Fix	HIZEN (16 / 4)	00010000	A4	37	0
	63	HCNT	Fix	HCNTFSYN (17 / 6)	01000000	A4	38	0

SERVICE DATA LISTS

Service Group	No.	Name	Fix / Var	Description	Bit Mask	Common		
						Slave Addr	Sub Addr	Fix Data
PIP	0	PFRN	Fix	VCXO oscilation	00000010	A4	40	0
	1	PRVS	Fix	HD/VD input synchronous mode selection	00000001	A4	40	1
	2	PCON	Fix	PIP sub contrast control	01111111	A4	41	97
	3	PUCO	Fix	PIP U level control	01111111	A4	42	5
	4	PVCO	Fix	PIP V level control	01111111	A4	43	17
	5	PHUE	Fix	PIP sub hue control	00111111	A4	57	12
	6	PKIL	Fix	Color killer	10000000	A4	42	0
	7	PSEP	Fix	C-sync sep input selection	11000000	A4	44	1
	8	PDCN	Fix	Sub pic sync sep. Thereshold setting	00110000	A4	44	3
	9	PBGS	Fix	bgp position setting	00111111	A4	45	15
	10	PDL0	Fix	Y/C delay adjust (for video)	00001111	A4	46	11
	11	PDL1	Fix	Y/C delay adjust (for yuv)	11110000	A4	46	13
	12	PBRT	Fix	Y bryghtness control	00011111	A4	48	25
	13	PVP1	Fix	V pedestal level for YUV	11110000	A4	49	0
	14	PUP1	Fix	U pedestal level for YUV	00001111	A4	49	0
	15	PVP2	Fix	V pedestal level for main w/ burst	11110000	A4	4A	0
	16	PUP2	Fix	U pedestal level for main w/ burst	00001111	A4	4A	0
	17	PVP3	Fix	V pedestal level for main w/o burst	11110000	A4	4B	0
	18	PUP3	Fix	U pedestal level for main w/o burst	00001111	A4	4B	0
	19	PACS	Fix	0D, 0Eh setting mode	01000000	A4	4C	1
	20	PSYS	Fix	Color system	00110000	=	=	
	21	PSDL	Fix	Sync delay control	00000011	A4	4C	0
	22	PCCL	Fix	YUV color level	11110000	A4	4D	11
	23	PCGA	Fix	Croma gain	00001000	A4	4D	0
24	PAAF	Fix	Auto AFC	00000100	A4	4D	1	

SERVICE DATA LISTS

Service Group	No.	Name	Fix / Var	Description	Bit Mask	Common		
						Slave Addr	Sub Addr	Fix Data
PIP	25	PSU2	Fix	For test	00000010	A4	4D	0
	26	PCVF	Fix	Internal 1H comb filter	00000001	A4	4D	0
	27	PBIT	Fix	Y clamp time constant	10000000	A4	4E	0
	28	PAFC	Fix	AFC time constant	01000000	A4	4E	0
	29	PACC	Fix	Color decoder amplitude	00111111	A4	4E	21
	30	PSDT	Fix	System automatic judgment	10000000	=	=	
	31	PBUR	Fix	VCXO mode selection	01000000	A4	4F	0
	32	PEVE	Fix	Main picture PAL-N	00100000	A4	4F	0
	33	PINW	Fix	Invert sub picture field definition	00010000	A4	4F	0
	34	PINR	Fix	Invert main picture field definition	00001000	A4	4F	0
	35	PVMD	Fix	Vertical display mode when pal-n	00000100	=	=	
	36	PREF	Fix	Main picture field fix	00000010	A4	4F	0
	37	PARE	Fix	Automatic 50/60 Hz judgement	00000001	A4	4F	0
	38	PBWD	Fix	BW det. Treshold setting	00110000	A4	50	1
	39	PFRA	Fix	Freq. Adjustment for free run mode	00001111	A4	51	0
	40	PPAL	Fix	Parameter setting for PAL-M judgment	11111111	A4	52	52
	41	PHPO	Fix	Sub picture h position	00111111	A4	58	3
	42	PVPO	Fix	Sub picture v position	00111111	A4	59	22
	43	PHTI	Fix	Display timing adjust	00001111	A4	44	3
	44	PHAJ	Fix	Main/Sub switch delay control	11110000	A4	47	2
	45	PBGY	Fix	Back ground Y level setting	00001111	A4	53	0
	46	PCRO	Fix	Sub picture read mode	10000000	A4	54	0
	47	PPAR	Fix	Thereshold contol for ident judgement of sub	00001111	A4	50	1
	48	PHPF	Fix	Y output HPF	00010000	A4	51	0
	49	PFSC	Fix	FSC output	10000000	A4	43	0
	50	PVCH	Fix	15h,16h,17h, setting mode	00000100	A4	4C	0
	51	PVON	Fix	V-chip decode mode	10000000	A4	53	1
	52	PVLN	Fix	V-chip data slicer line selection	00011111	A4	54	17
	53	PVSB	Fix	V-chip data slicer start bit detection parameter	11111111	A4	55	64
	54	PVLV	Fix	V-chip data slicer slice parameter	11111111	A4	56	130
55	SUSW	Fix	Sub-Unlock bit position switch	01000000	A4	59	0	

SERVICE DATA LISTS

Service Group	No.	Name	Fix / Var	Description	Bit Mask	KV-27FV300/29FV300				KV-32FV300/36FV300			
						Slave Addr	Sub Addr	Fix Data	Var Data	Slave Addr	Sub Addr	Fix Data	Var Data
AP	0	SBAL	Fix	Sub Balance	00000111	A8	41		4	A8	41		4
	1	SBAS	Fix	Sub Bass	00000111	A8	43		4	A8	43		4
	2	STRE	Fix	Sub Treble	00000111	A8	42		0	A8	42		0
	3	SRL	Fix	Surround level	00000001	A8	44		0	A8	44		0
	4	BBOH	Fix	Surround Off - BBE high	11110000	A8	45		10	A8	45		10
	5	BBOL	Fix	Surround Off - BBE low	00001111	A8	45		5	A8	45		5
	6	BBSH	Fix	Simulated - BBE high	11110000	A8	46		0	A8	46		0
	7	BBSL	Fix	Simulated - BBE low	00001111	A8	46		0	A8	46		0
	8	BBMH	Fix	Surround - BBE high	11110000	A8	47		0	A8	47		0
	9	BBML	Fix	Surround - BBE low	00001111	A8	47		0	A8	47		0
	10	BBGH	Fix	WOW - BBE high	11110000	A8	48		6	A8	48		6
	11	BBGL	Fix	WOW - BBE low	00001111	A8	48		9	A8	48		9
	12	BBTH	Fix	Trusurround - BBE high	11110000	A8	49		7	A8	49		7
	13	BBTL	Fix	Trusurround - BBE low	00001111	A8	49		8	A8	49		8
	14	VFIX	Fix	Audio output fix data	11111111	A8	4A		244	A8	4A		244
15	AGCL	Fix	AGC Level	00000110	A8	44		2	A8	44		2	

Service Group	No.	Name	Fix / Var	Description	Bit Mask	Common		
						Slave Addr	Sub Addr	Fix Data
CCD	0	DUM0	Fix	Only for testing	11111111	=	=	
	1	VOSD	Fix	Only for testing	00000001	=	=	

Service Group	No.	Name	Fix / Var	Description	Bit Mask	Common		
						Slave Addr	Sub Addr	Fix Data
OP	0	DISP	Fix	OSD Display position	00111111	A4	06	28
	1	RAMW	Fix		00000001	=	=	
	2	ICMP	Fix	Comparison data to determine Non-interlace signal for OSD	00011111	A4	39	4
	3	IPOR	Fix	0:Even, 1: Odd, Other: do not change	00000011	A4	3A	1
	4	FAWD	Fix	1: Forced to auto wide mode, 0:normal	00000100	A0	5D	0
	5	HCLW	Fix	H-Count Lower limit	11111111	A4	02	67
	6	HCHG	Fix	H-Count Higher limit	11111111	A4	03	254
	7	9VTM	Fix	Delay for 9V check subsystem	11111111	A4	04	55
8	ZDET	Fix	Zero detect relay delay	11111111	A4	05	123	

Service Group	No.	Name	Fix / Var	Description	Bit Mask	Slave Addr	Sub Addr	Var Data
1	ID1	Fix	Model variation ID1	11111111	A4	79	SEE ID MAP	
2	ID2	Fix	Model variation ID2	11111111	A4	7A	SEE ID MAP	
3	ID3	Fix	Model variation ID3	11111111	A4	7B	SEE ID MAP	
4	ID4	Fix	Model variation ID4	11111111	A4	7C	SEE ID MAP	
5	ID5	Fix	Model variation ID5	11111111	A4	7D	SEE ID MAP	
6	ID6	Fix	Model variation ID6	11111111	A4	7E	SEE ID MAP	
7	ID7	Fix	Model variation ID7	11111111	A4	7F	SEE ID MAP	

To determine ID's value, ID map must be referred

4-5. ID MAP TABLE

Model	Destination	ID-0	ID-1	ID-2	ID-3	ID-4	ID-5	ID-6	ID-7
KV-27FV300	US	89	63	237	98	78	128	6	16
KV-27FV300	CND	89	63	237	82	78	128	6	16
KV-29FV300	E	81	63	237	194	110	128	6	80
KV-32FV300	US	89	63	237	98	78	128	6	24
KV-32FV300	CND	89	63	237	82	78	128	6	24
KV-36FV300	US/HAW	89	63	237	98	78	128	6	24
KV-36FV300	CND	89	63	237	82	78	128	6	24

4-6. A BOARD ADJUSTMENTS

H. FREQUENCY (FREE RUN) CHECK

1. Input a TV mode (RF) with no signal.
2. Connect a frequency counter to base of Q501 (TP-25 H. DRIVE) on the A Board.
3. Check H. Frequency for $15734 \pm 400/-200$ Hz.

V. FREQUENCY (FREE RUN) CHECK

1. Select video 1 with no signal input.
2. Set the conditions for a standard setting.
3. Connect the frequency counter to TP-27 (V OUT) or CN501 pin ⑥ (V DY+) and ground on the A Board .
4. Check that V. Frequency shows 60 ± 5 Hz.

SUBCONTRAST ADJUSTMENT (RDRV)

1. Input a color-bar signal and set the level to 75%.
2. Set in Standard mode.
3. Activate the Service Adjustment Mode. Set color min pic max.
4. Set GON and BON items. Using ③ and ⑥ set each to the following values. Leave RON set to "1".

Signal Type	Mode	Category	Display Item	Item Data
ntsc	service	video	rdrv	26
	vchp			00000000 00000000

R ON: ON (1)
G ON: OFF (0)
B ON: OFF (0)

5. Connect an oscilloscope probe to C Board, CN705 pin 3 (Red Out) (TP35).
6. Select SCON with ① and ④ .

7. Adjust the value of SCON with ③ and ⑥ for $1.90 \pm 0.05V_{pp}$ for 27/29/32/34", or $1.95 \pm 0.05V_{pp}$ for 36/38".

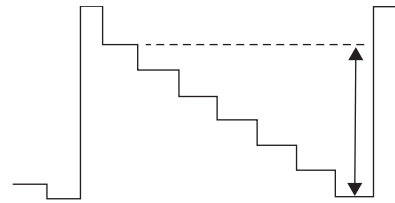

8. Reset AALS, ABLs, GON and BON values to "1".
R ON: ON (1)
G ON: ON (1)
B ON: ON (1)
9. Press [MUTING] then [ENTER] to save into the memory.

DISPLAY POSITION ADJUSTMENT (DISP)

1. Input a color-bar signal.
2. Set to Service Adjustment Mode.
3. Select DISP with ① and ④ .
4. Adjust values of DISP with ③ and ⑥ to adjust characters to the center.
5. Write to memory by pressing [MUTING] then [ENTER] .
6. Check to see if the text is displayed on the screen.

Signal Type	Mode	Category	Display Item	Item Data
ntsc	service	micro	disp	48
	vchp			00000000 00000000

SUB BRIGHT ADJUSTMENT (SBRT)

1. Input a monoscope signal.
2. Activate the Service Adjustment Mode.
3. Set the PICTURE and BRIGHTNESS to minimum.
4. Select the SBRT item with ① and ④ .
5. Adjust the values of SBRT with ③ and ⑥ to obtain a faintly visible crosshatch.
6. Press [MUTING] then [ENTER] to save into the memory.

SUB HUE, SUB COLOR ADJUSTMENT (SHUE, SCOL)

1. Input color-bar signal at 75%.
2. Activate the Service Adjustment Mode.
3. Set (PIC) to Max and (COL) to 50%.
4. Connect an oscilloscope probe to C Board, CN705Pin ④ Blue Out.
5. Select the SHUE and SCOL item with ① and ④ .

- While showing the SHUE item, adjust the waveform with **1** and **4** until the second and third bars show the same level ($V2 = V3 < 0.15V_{p-p}$).
- While showing the SCOL item, adjust the waveform with **3** and **6** until the first and fourth bars show the same level ($V1 = V4 < 0.15V_{p-p}$).

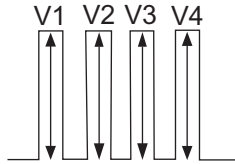

- Press **MUTING** then **ENTER** to save into the memory.

V. SIZE ADJUSTMENT (VSIZ)

- Input a crosshatch signal.
- Activate the Service Adjustment Mode.
- Select the VSIZ item with **1** and **4**.
- Adjust value of VPOS with **1** and **4** for the best vertical center.
- Press **MUTING** then **ENTER** to save into the memory.

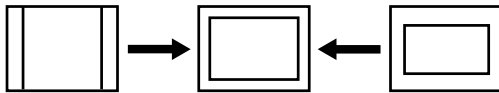

V. CENTER ADJUSTMENT (VPOS)

Perform this adjustment after performing H. Frequency (Free Run) Check.

- Input a crosshatch signal.
- Activate the Service Adjustment Mode.
- Select the VPOS item with **1** and **4**.
- Adjust value of VPOS with **3** and **6** for the best vertical center.
- Press **MUTING** then **ENTER** to save into the memory.

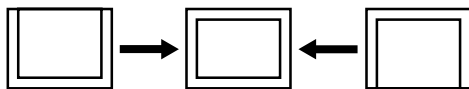

H. CENTER ADJUSTMENT (HPOS)

Perform this adjustment after performing H. Frequency (Free Run) Check.

- Input a crosshatch signal.
- Activate the Service Adjustment Mode.
- Select the HPOS item with **1** and **4**.
- Adjust the value of HPOS with **3** and **6** for the best horizontal center.
- Press **MUTING** then **ENTER** to save into the memory.

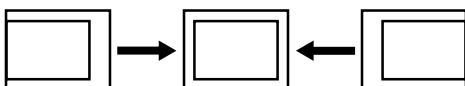

H. SIZE ADJUSTMENT (HSIZ)

- Input a monoscope signal.
- Activate the Service Adjustment Mode.
- Select HSIZ with **1** and **4**.
- Adjust with **3** and **6** for the best horizontal size.
- Press **MUTING** then **ENTER** to save into the memory.

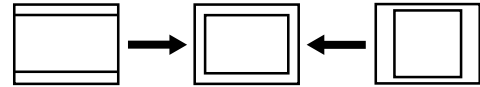

V. LINEARITY (VLIN), V. CORRECTION (SCOR), PIN AMP (PAMP), AND HORIZONTAL TRAPEZOID (HTRP) ADJUSTMENTS

- Input a crosshatch signal.
- Activate the Service Adjustment Mode.
- Select VLIN, SCOR, PAMP, and HTRP with with **1** and **4**.
- Adjust with **3** and **6** for the best horizontal size.
- Press **MUTING** then **ENTER** to save into the memory.

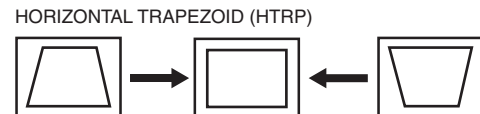
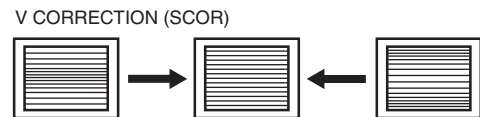
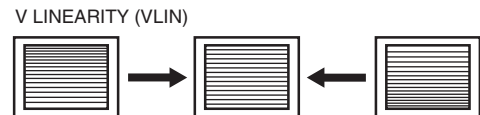

V. ANGLE (VANG), V. BOW (VBOW), UPPER PIN (UPIN) AND LOW PIN (LPIN) ADJUSTMENTS

1. Input a crosshatch signal.
2. Activate the Service Adjustment Mode.
3. Select VANG, VBOW, UPIN, and LPIN with **[1]** and **[4]**.
4. Adjust with **[3]** and **[6]** for the best picture.
5. Press **[MUTING]** then **[ENTER]** to save into the memory.

V ANGLE (VANG)

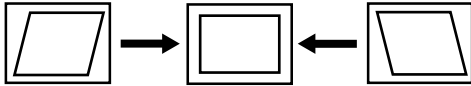

V BOW (VBOW)

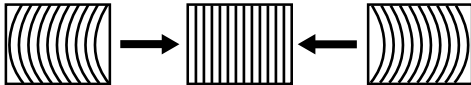

UPPER PIN (UPIN)

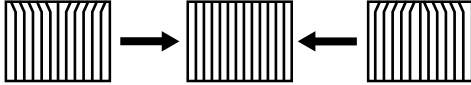

LOW PIN (LPIN)

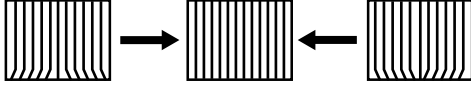

SERVICE ADJUSTMENT MODE MEMORY

1. After completing all adjustments, press **[0]** then **[ENTER]**.

Read From Memory

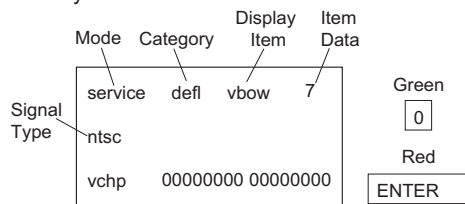

SECTION 5: DIAGRAMS

5-1. CIRCUIT BOARDS LOCATION

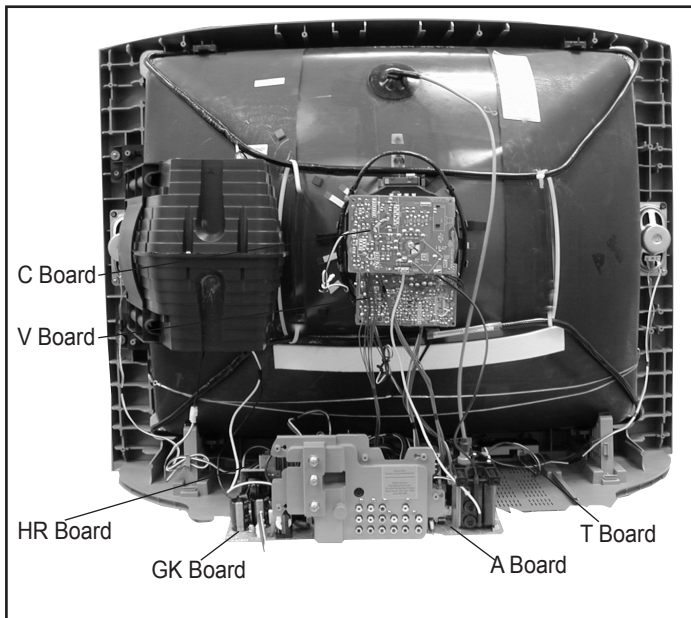

5-2. PRINTED WIRING BOARDS AND SCHEMATIC DIAGRAMS INFORMATION

All capacitors are in μF unless otherwise noted. pF : μF 50WV or less are not indicated except for electrolytics and tantalums.

All electrolytics are in 50V unless otherwise specified.

All resistors are in ohms. $\text{k}\Omega=1000\Omega$, $\text{M}\Omega=1000\text{k}\Omega$

Indication of resistance, which does not have one for rating electrical power, is as follows: Pitch : 5mm
Rating electrical power : $\frac{1}{4}\text{W}$

$\frac{1}{4}\text{W}$ in resistance, $\frac{1}{10}\text{W}$ and $\frac{1}{8}\text{W}$ in chip resistance.

: nonflammable resistor

: fusible resistor

: internal component

: panel designation and adjustment for repair

: earth ground

: earth-chassis

All variable and adjustable resistors have characteristic curve B, unless otherwise noted.

Readings are taken with a color-bar signal input.

Readings are taken with a $10\text{M}\Omega$ digital multimeter.

Voltages are DC with respect to ground unless otherwise noted.

Voltage variations may be noted due to normal production tolerances.

All voltages are in V.

S : Measurement impossibility.

: B+line

: B-line (Actual measured value may be different).

: signal path (RF)

Circled numbers are waveform references.

The components identified by shading and are critical for safety. Replace only with part number specified.

The symbol indicates a fast operating fuse and is displayed on the component side of the board. Replace only with fuse of the same rating as marked.

Les composants identifiés par un trame et une marque sont critiques pour la sécurité. Ne les remplacer que par une pièce portant le numéro spécifié.

Le symbole indique une fusible à action rapide. Doit être remplacé par une fusible de même valeur, comme marqué.

The components identified by in this basic schematic diagram have been carefully factory-selected for each set in order to satisfy regulations regarding X-ray radiation. Should replacement be necessary, replace only with the value originally used.

When replacing components identified by , make the necessary adjustments as indicated. If the results do not meet the specified value, change the component identified by and repeat the adjustment until the specified value is achieved.

(Refer to R530 and R531 adjustment on page 16.)

When replacing the parts listed in the table below, it is important to perform the related adjustments.

Part Replaced ()	Adjustment ()
A BOARD: R550, T503, T504, D519, IC501, R533, D521, R532, D520, C531, R529, R530, R531, C532	HV HOLD DOWN R530, R531

REFERENCE INFORMATION

RESISTOR

: RN METAL FILM
: RC SOLID
: RPRD NONFLAMMABLE CARBON
: FUSE NONFLAMMABLE FUSIBLE
: RW NONFLAMMABLE WIREWOUND
: RS NONFLAMMABLE METAL OXIDE
: RB NONFLAMMABLE CEMENT
: ADJUSTMENT RESISTOR

COIL

: LF-8L MICRO INDUCTOR

CAPACITOR

: TA TANTALUM
: PS STYROL
: PP POLYPROPYLENE
: PT MYLAR
: MPS METALIZED POLYESTER
: MPP METALIZED POLYPROPYLENE
: ALB BIPOLAR
: ALT HIGH TEMPERATURE
: ALR HIGH RIPPLE

5-3. BLOCK DIAGRAM AND SCHEMATICS

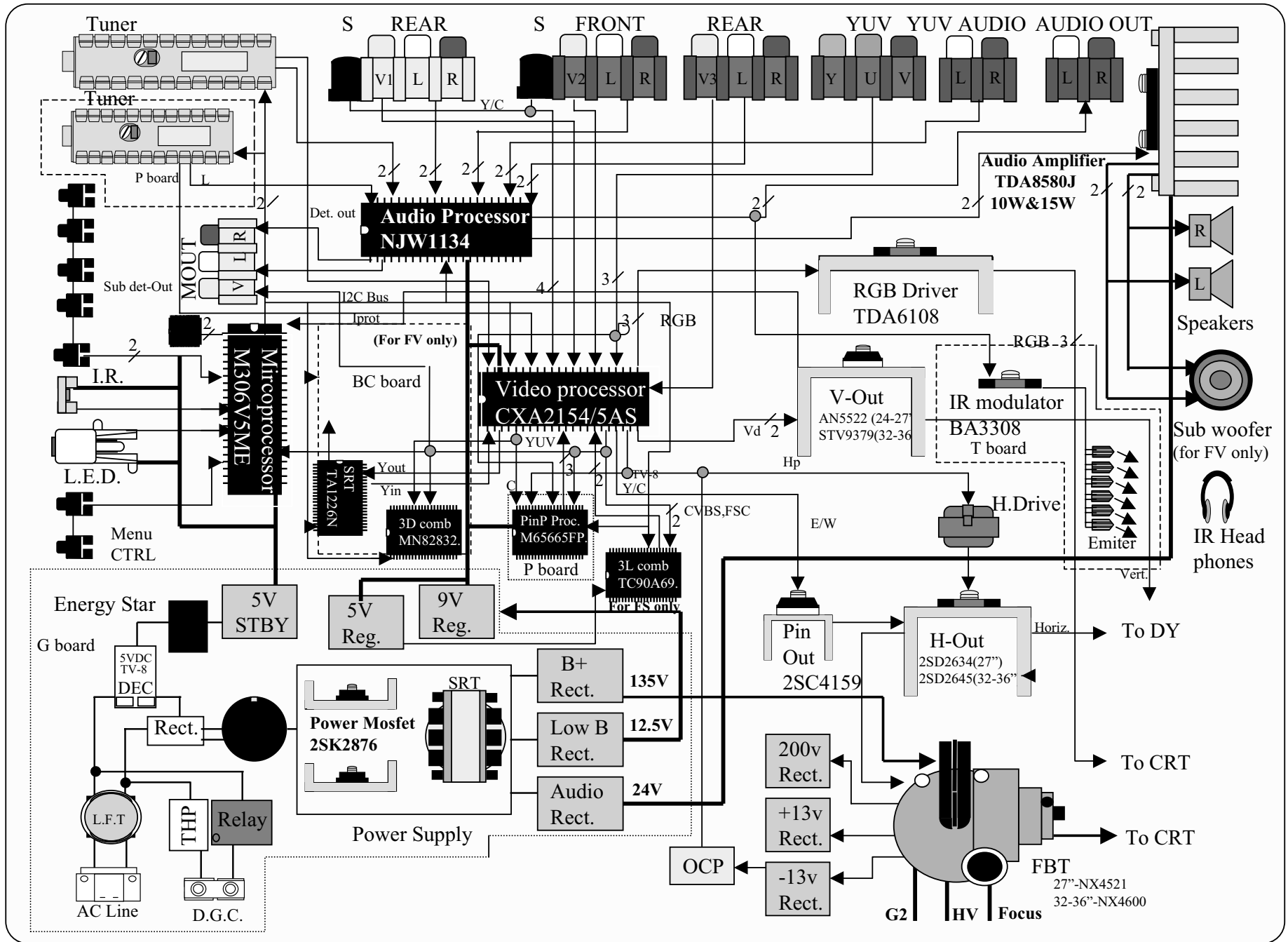

A BOARD SCHEMATIC DIAGRAM

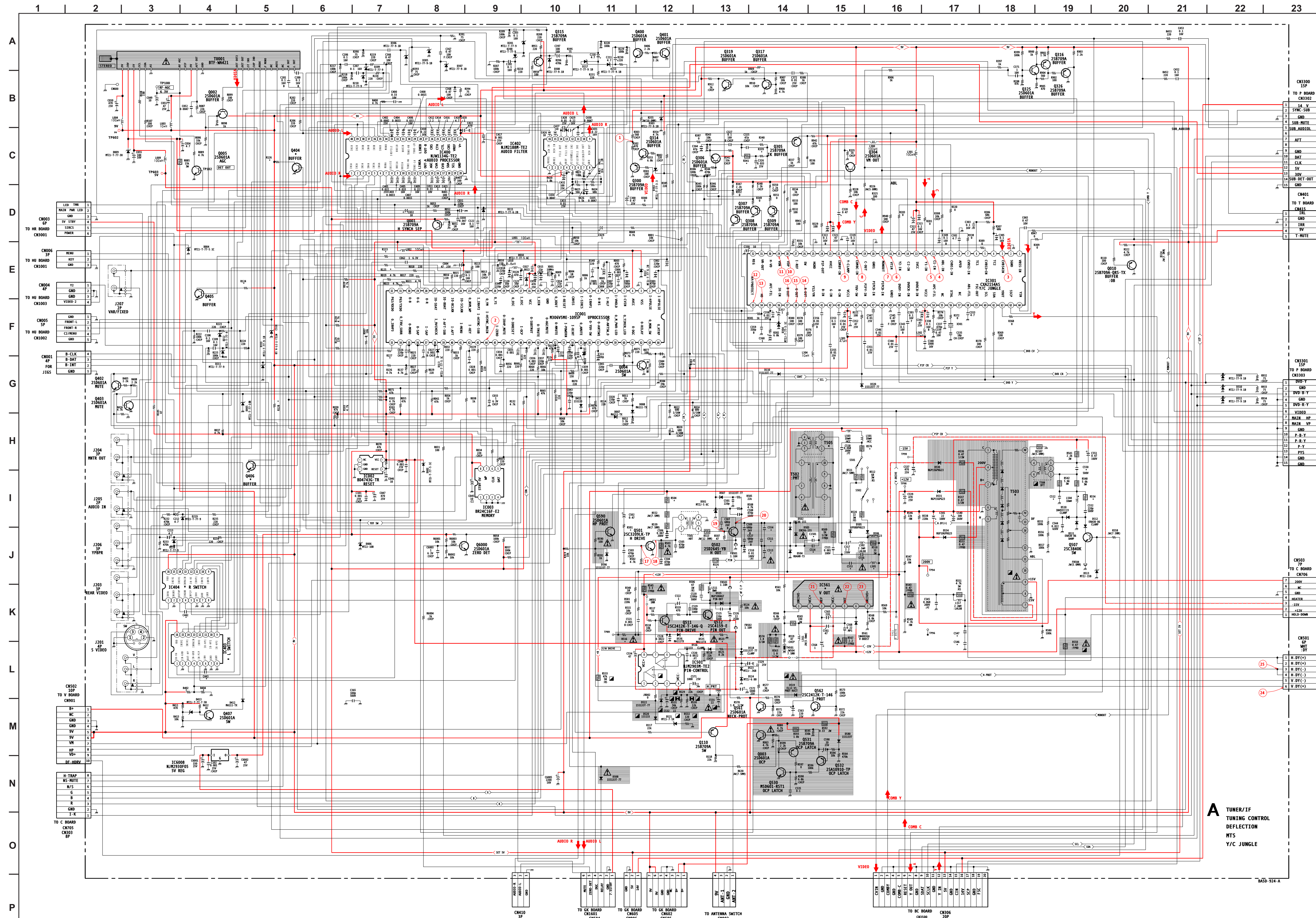

A TUNER/IF
TUNING CONTROL
DEFLECTION
NTS
Y/C JUNGLE

9A50-924-A

A

[TUNING CONTROL, DEFLECTION, TUNER/IF, Y/C JUNGLE, MTS]

1 2 3 4 5 6 7 8 9 10 11 12

A
B
C
D
E
F
G
H
I

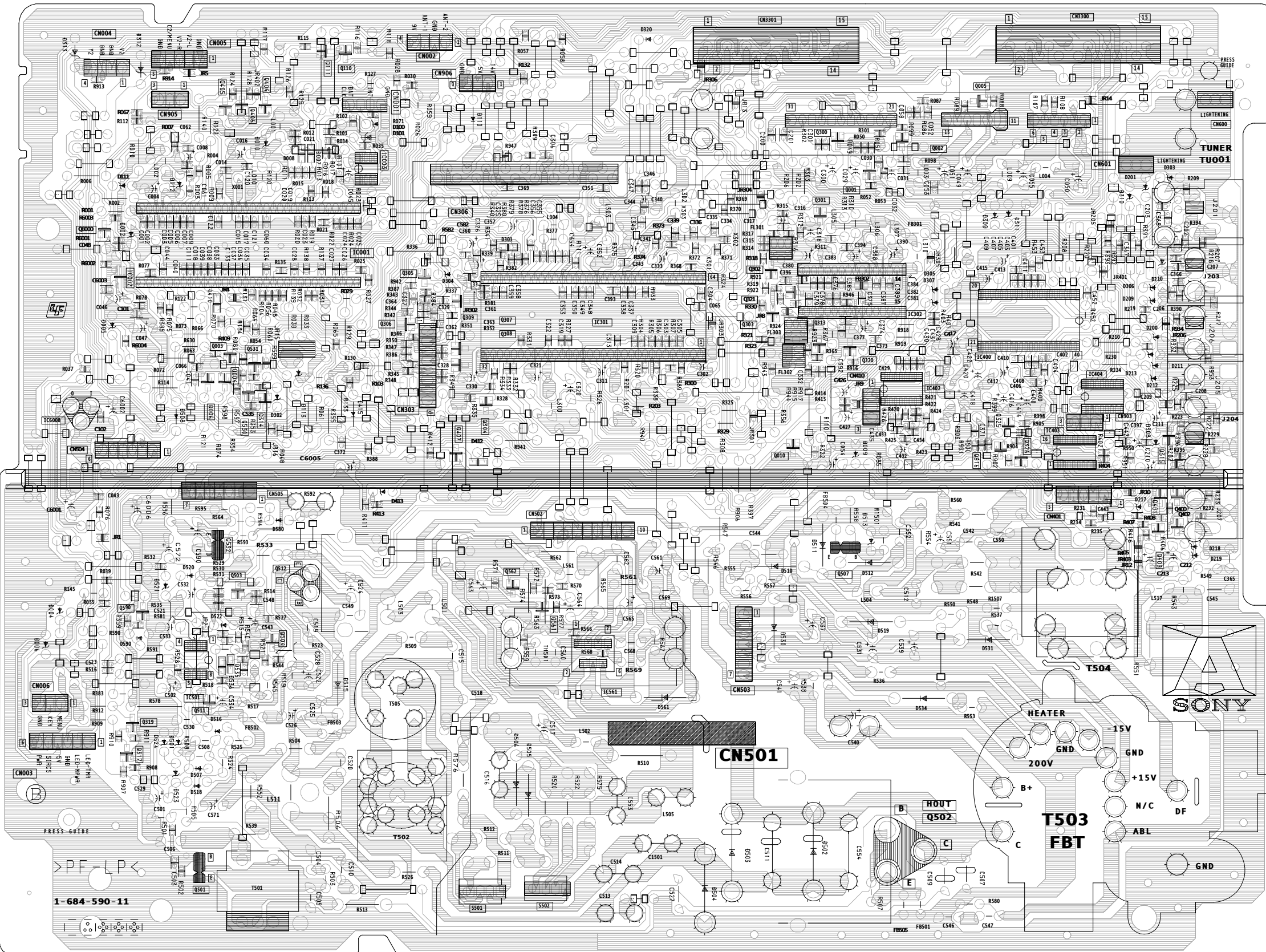

A BOARD LOCATOR LIST

DIODE		D501	G-2	TRANSISTOR	
D002	C-2	D502	H-8	Q001	B-8
D004	F-1	D503	H-7	Q002	B-9
D005	D-2	D504	I-7	Q003	D-3
D006	F-1	D505	H-5	Q004	D-3
D007	B-4	D507	H-2	Q005	A-10
D008	B-3	D508	D-2	Q010	E-8
D009	E-8	D510	F-8	Q110	A-4
D010	B-3	D511	F-8	Q111	A-4
D110	B-5	D512	F-9	Q300	B-8
D111	B-2	D513	F-9	Q304	D-5
D112	B-2	D515	G-4	Q305	C-4
D113	D-3	D516	G-3	Q306	D-4
D200	D-11	D518	H-2	Q307	C-5
D201	B-11	D519	F-9	Q308	D-5
D209	C-11	D520	F-2	Q309	C-5
D210	C-11	D521	F-2	Q314	D-3
D211	D-11	D522	F-3	Q315	E-11
D212	D-11	D523	H-2	Q316	E-10
D213	D-11	D524	G-2	Q317	G-2
D217	E-11	D530	F-8	Q319	G-2
D218	F-12	D531	F-10	Q325	E-10
D219	F-12	D534	G-9	Q326	E-10
D302	D-3	D535	G-3	Q400	E-11
D303	B-11	D536	G-3	Q401	E-11
D304	C-5	D561	G-7	Q402	E-12
D305	C-9	D580	E-3	Q403	E-11
D306	C-11	D590	F-2	Q404	A-3
D307	C-9	IC		Q405	A-3
D308	E-11	IC001	C-3	Q406	B-3
D309	B-10	IC002	C-2	Q407	E-5
D310	B-11	IC003	B-4	Q501	H-2
D311	B-10	IC301	C-6	Q502	H-9
D312	A-2	IC400	D-10	Q507	F-8
D313	A-1	IC402	D-9	Q511	G-3
D320	A-7	IC403	E-10	Q512	F-3
D410	C-2	IC404	D-11	Q530	D-3
D412	E-5	IC501	G-2	Q531	D-3
D413	E-4	IC561	G-6	Q532	F-3
D415	D-4	IC6008	D-1	Q561	F-6
				Q562	F-5
				Q590	F-2
				Q6000	C-1

A BOARD WAVEFORM

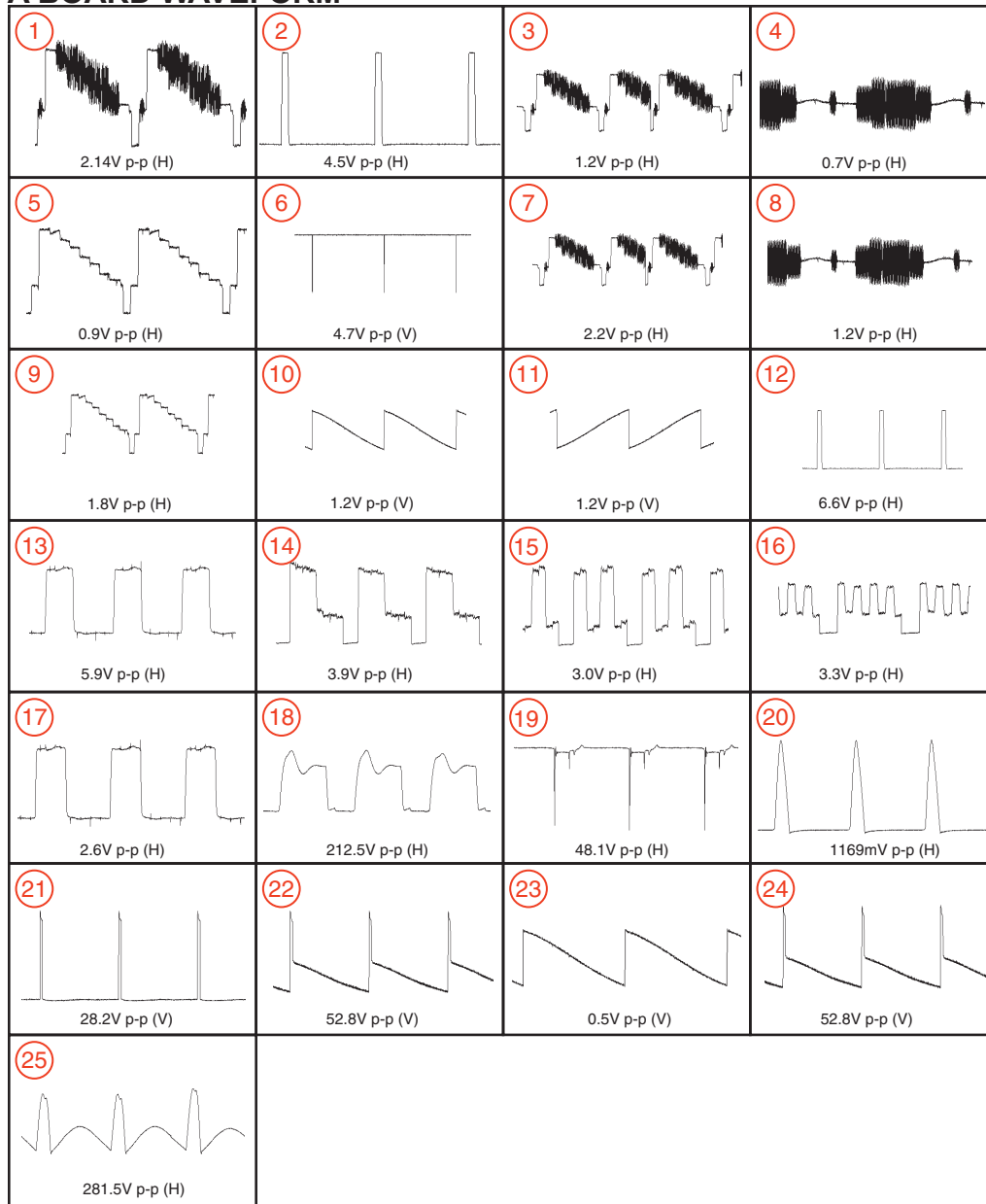

A BOARD MARK(*) LIST

REF. NO.	LOCATION	KV-27FV300 KV-29FV300	KV-32FV300	KV-36FV300
C442	K-3	#	0.22UF	0.22UF
C443	L-4	#	0.22UF	0.22UF
C511	I-13	17000PF	22000PF	22000PF
C512	I-19	0.0039UF	0.0027UF	0.0027UF
C513	J-13	0.047UF	0.051UF	0.051UF
C514	I-14	0.68UF	0.82UF	0.82UF
C516	J-15	1UF	0.82UF	0.82UF
C546	K-17	#	0.001UF	0.001UF
C547	K-17	#	0.001UF	0.001UF
C550	H-19	0.0015UF	680PF	680PF
C553	J-15	0.1UF	0.47UF	0.47UF
C554	I-13	2700PF	4700PF	4700PF
C1501	I-14	#	0.1UF	0.1UF
CN401	D-23	#	5P	5P
IC403	K-4	#	BU4051BCF-E2	BU4051BCF-E2
IC404	J-4	#	BU4051BCF-E2	BU4051BCF-E2
IC561	J-14	TDA8172	STV9379	STV9379
L505	J-15	150UH	68UH	68UH
Q404	C-5	#	2SD601A-QRS-TX	2SD601A-QRS-TX
Q405	E-4	#	2SD601A-QRS-TX	2SD601A-QRS-TX
Q406	H-5	#	2SD601A-QRS-TX	2SD601A-QRS-TX
R123	E-7	#	2.2K	2.2K
R124	E-4	#	220	220
R125	E-7	#	2.2K	2.2K
R126	C-5	#	220	220
R127	F-7	#	2.2K	2.2K
R128	G-5	#	220	220
R339	C-13	330K	39K	39K
R340	C-13	2.2M	3.3M	3.3M
R341	C-13	56K	330K	330K
R402	L-3	#	4.7K	4.7K
R404	L-4	#	4.7K	4.7K
R501	I-11	330	470	470
R504	I-12	68	560	560
R516	K-11	8.2K	5.6K	6.8K
R523	K-13	22K	12K	12K
R526	J-12	4.7	10	10
R554	I-19	15K	2.2K	#
R576	H-15	22	10	10
T503	I-18	8-598-834-20	8-598-824-10	8-598-824-10
T505	H-15	1-431-693-11	1-435-098-11	1-435-098-11

#: Not Mounted

IC BLOCK DIAGRAM

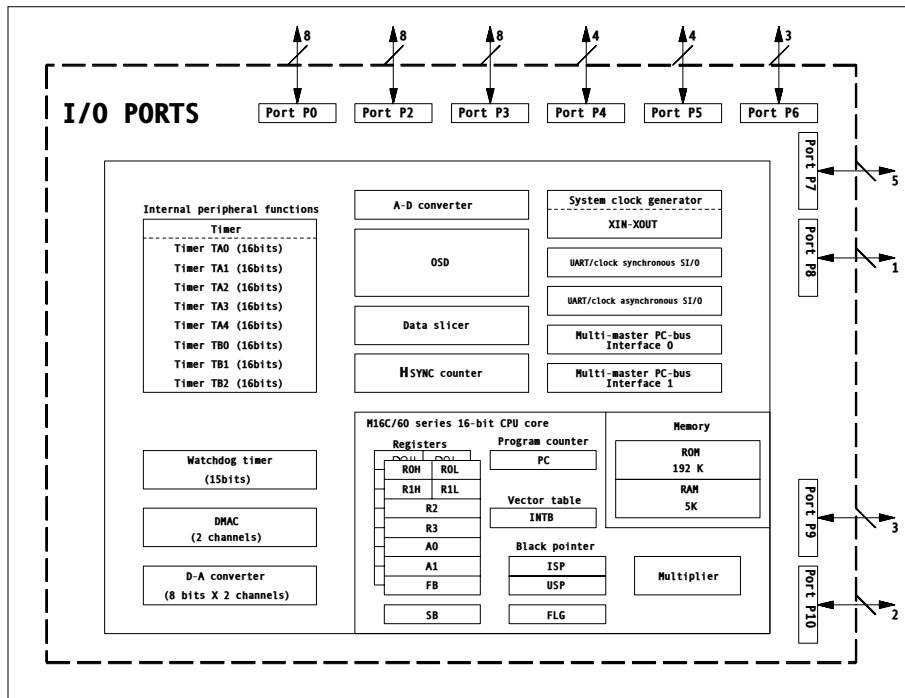

A BOARD IC VOLTAGE LIST

IC001		41	5.0	IC301		41	4.6	17	1.7	IC403		5	2.3
PIN	VOLT	42	5.0	PIN	VOLT	42	4.6	18	4.7	PIN	VOLT	6	2.5
1	4.9	43	0.2	1	5.0	43	4.6	19	4.7	1	4.5	7	-13.5
2	0.6	44	0.6	2	GND	44	9.0	20	GND	2	GND	8	12.0
3	GND	45	1.2	3	5.0	45	0.1	21	9.0	3	4.5	IC561	
4	5.0	46	4.8	4	5.0	46	4.3	22	4.4	4	0.0	PIN	VOLT
5	0.2	47	4.8	5	4.8	47	5.2	23	3.8	5	4.5	1	1.5
6	1.7	48	0.0	6	5.0	48	5.2	24	3.8	6	GND	2	12.0
7	1.4	49	0.1	7	4.8	49	GND	25	4.0	7	GND	3	-12.0
8	0.5	50	4.4	8	3.4	50	4.8	26	0.6	8	GND	4	-15.0
9	0.0	51	5.0	9	5.2	51	5.2	27	4.6	9	9.0	5	0.3
10	5.0	52	0.1	10	1.9	52	5.2	28	4.6	10	9.0	6	14.2
11	GND	53	0.0	11	0.0	53	9.1	29	4.6	11	9.0	7	1.4
12	5.0	54	4.8	12	4.8	54	5.3	30	4.6	12	4.5	IC6008	
13	2.3	55	0.1	13	9.0	55	N/C	31	4.6	13	4.5	PIN	VOLT
14	GND	56	0.0	14	0.0	56	1.7	32	4.6	14	4.5	I	7.5
15	2.1	57	4.8	15	4.8	57	N/C	33	4.6	15	4.5	O	5.0
16	5.0	58	N/C	16	4.9	58	6.9	34	4.6	16	9.0	G	GND
17	2.6	59	N/C	17	4.4	59	N/C	35	4.5	IC404		All voltages are in V.	
18	2.6	60	0.0	18	0.0	60	4.7	36	4.5	PIN	VOLT		
19	0.3	61	0.1	19	3.8	61	4.7	37	4.5	1	4.5		
20	0.0	62	4.6	20	5.5	62	4.7	38	4.5	2	GND		
21	2.1	63	0.1	21	3.6	63	1.1	39	4.5	3	0.4		
22	5.0	64	N/C	22	5.8	64	5.1	40	4.5	4	0.4		
23	5.0	IC002		23	9.0	IC400		IC402		5	4.5		
24	5.0	PIN	VOLT	24	4.4	PIN	VOLT	PIN	VOLT	6	GND		
25	5.0	1	N/C	25	0.0	1	4.5	1	GND	7	0.0		
26	5.0	2	GND	26	4.1	2	4.5	2	0.3	8	GND		
27	5.0	3	GND	27	2.4	3	4.5	3	9.0	9	9.0		
28	0.0	4	5.0	28	3.5	4	4.5	4	4.5	10	9.0		
29	0.0	5	5.0	29	3.5	5	4.5	5	4.5	11	9.0		
30	0.0	IC003		30	5.9	6	4.5	6	4.5	12	4.5		
31	N/C	PIN	VOLT	31	5.5	7	4.5	7	4.5	13	4.5		
32	N/C	1	GND	32	7.6	8	4.5	8	GND	14	4.5		
33	4.8	2	GND	33	3.6	9	4.5	9	4.5	15	4.5		
34	0.0	3	GND	34	2.8	10	4.5	10	4.5	16	9.0		
35	0.0	4	GND	35	2.5	11	4.5	11	4.5	IC501			
36	0.0	5	5.0	36	3.9	12	4.5	12	4.5	PIN	VOLT		
37	0.0	6	5.0	37	1.5	13	4.5	13	4.5	1	-13.3		
38	4.2	7	0.0	38	1.6	14	4.5	14	4.5	2	8.2		
39	1.7	8	5.0	39	1.5	15	0.6	15	4.5	3	7.2		
40	2.6			40	0.0	16	1.7	16	4.5	4	-15.0		

A BOARD TRANSISTOR VOLTAGE LIST

	B	C	E		B	C	E
Q001	0.0	0.4	5.0	Q400	0.0	0.0	GND
Q002	4.4	9.0	3.8	Q401	0.0	0.0	GND
Q003	0.7	0.0	GND	Q402	0.0	0.0	GND
Q004	0.0	4.3	GND	Q403	0.0	0.0	GND
Q005	0.1	4.9	GND	Q404	0.0	9.1	GND
Q010	4.3	GND	4.9	Q405	0.0	9.1	GND
Q110	4.8	0.0	5.0	Q406	0.0	9.1	GND
Q300	4.6	GND	5.2	Q407	0.7	0.0	GND
Q304	5.0	9.0	4.4	Q501	0.0	123.6	GND
Q305	5.0	0.0	3.4	Q502	0.0	131.8	0.0
Q306	2.0	9.0	2.3	Q507	0.3	110.7	GND
Q307	1.5	GND	2.2	Q511	-13.5	-8.4	-15.0
Q308	1.5	GND	2.2	Q512	-14.9	-2.0	-15.0
Q309	1.5	GND	2.2	Q530	0.0	4.4	GND
Q314	0.0	3.4	GND	Q531	4.4	0.0	4.4
Q315	3.4	GND	4.1	Q532	133.6	0.0	133.8
Q316	6.4	2.7	7.1	Q561	0.0	4.4	GND
Q317	0.0	3.9	GND	Q562	0.0	0.0	GND
Q319	0.6	0.6	GND	Q590	0.0	3.6	GND
Q325	2.6	6.4	1.9	Q6000	0.6	1.2	GND
Q326	2.7	GND	3.4				

All voltages are in V.

BC BOARD SCHEMATIC DIAGRAM

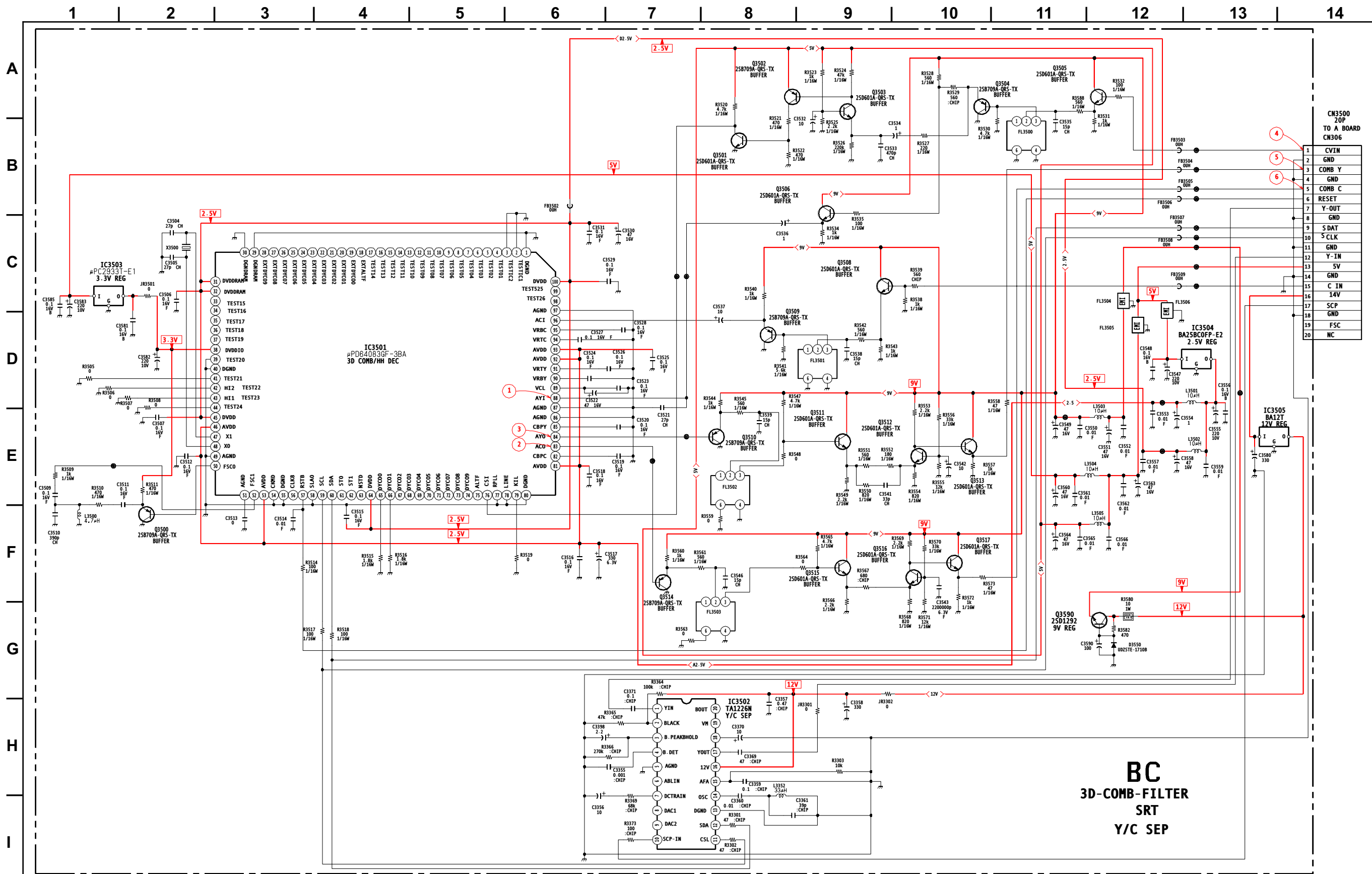

1	CVIN
2	GND
3	COMB Y
4	GND
5	COMB C
6	RESET
7	Y-OUT
8	GND
9	S DAT
10	S CLK
11	GND
12	Y-IN
13	5V
14	GND
15	C IN
16	14V
17	SCP
18	GND
19	FSC
20	NC

BC
3D-COMB-FILTER
SRT
Y/C SEP

BA5D-924-BC

BC

[3D COMB FILTER, SRT, Y/C SEP] COMPONENT SIDE

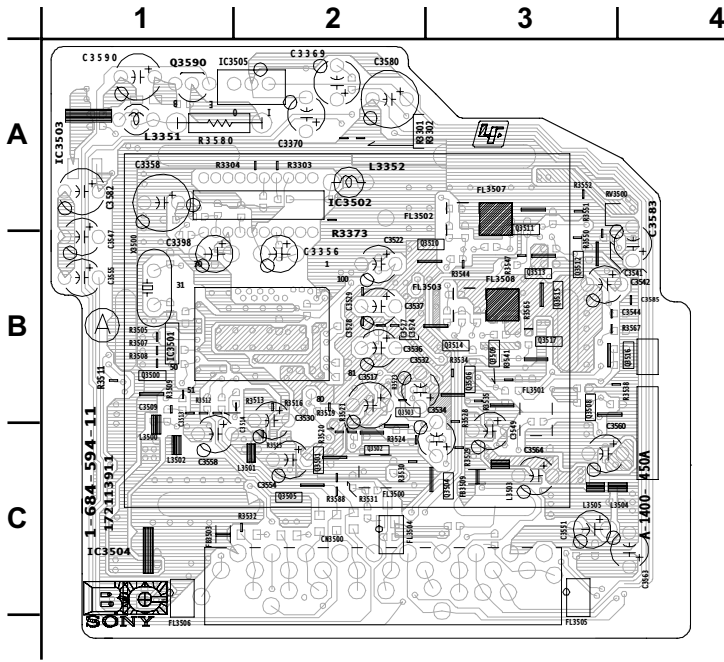

BC BOARD WAVEFORM

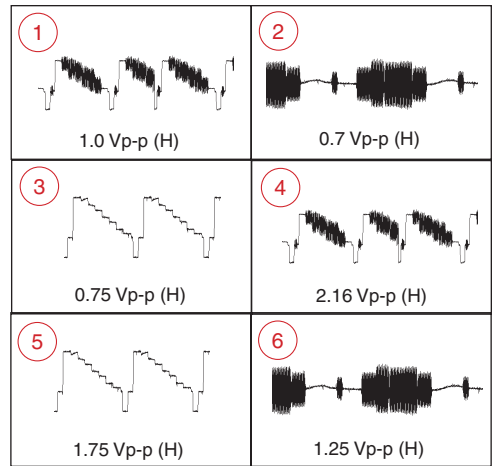

BC

[3D COMB FILTER, SRT, Y/C SEP] CONDUCTOR SIDE

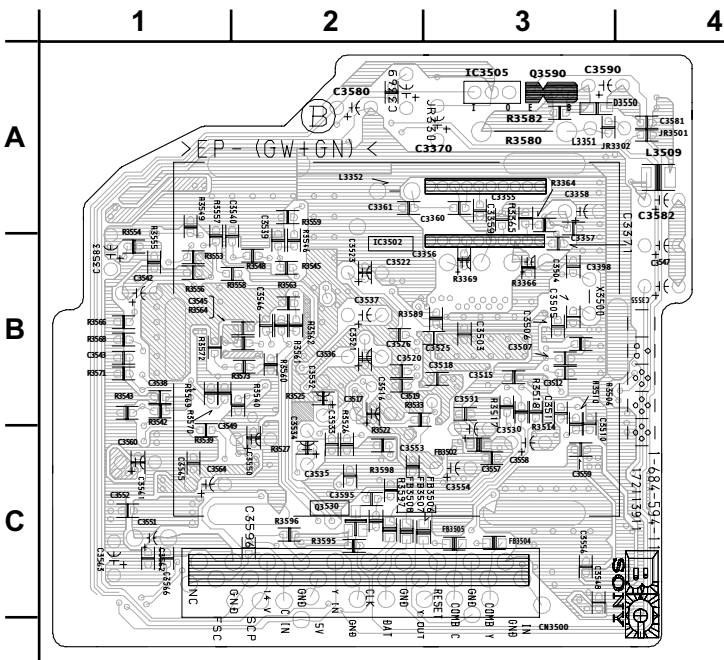

BC BOARD IC VOLTAGE LIST

IC3501		27	N/C	55	GND	83	1.4	9	N/C
PIN	VOLT	28	N/C	56	N/C	84	1.4	10	1.2
1	GND	29	GND	57	4.8	85	1.1	11	4.7
2	GND	30	GND	58	GND	86	GND	12	4.7
3	GND	31	2.5	59	4.7	87	0.0	13	0.0
4	N/C	32	2.5	60	4.7	88	1.1	14	11.5
5	N/C	33	N/C	61	N/C	89	0.7	15	4.8
6	N/C	34	N/C	62	N/C	90	0.7	16	12.0
7	N/C	35	N/C	63	N/C	91	1.3	17	0.0
8	N/C	36	N/C	64	2.5	92	2.5	18	0.5
9	N/C	37	N/C	65	0.0	93	2.5	19	N/C
10	N/C	38	3.3	66	0.0	94	0.0	20	N/C
11	N/C	39	GND	67	N/C	95	0.0	IC3503	
12	N/C	40	GND	68	N/C	96	1.1	PIN	VOLT
13	N/C	41	GND	69	N/C	97	GND	I	5.0
14	N/C	42	GND	70	N/C	98	N/C	O	3.3
15	N/C	43	GND	71	N/C	99	N/C	G	GND
16	N/C	44	GND	72	N/C	100	2.5	IC3504	
17	N/C	45	2.5	73	N/C	IC3502		PIN	VOLT
18	N/C	46	2.5	74	N/C	PIN	VOLT <td>I</td> <td>5.0</td>	I	5.0
19	N/C	47	1.3	75	N/C	1	4.7	O	2.5
20	N/C	48	1.0	76	4.2	2	3.8	G	GND
21	N/C	49	GND	77	GND	3	3.9	IC3505	
22	N/C	50	1.4	78	GND	4	4.7	PIN	VOLT
23	N/C	51	GND	79	GND	5	GND	I	14.0
24	N/C	52	1.3	80	GND	6	N/C	O	12.0
25	N/C	53	2.5	81	2.5	7	4.8	G	GND
26	N/C	54	GND	82	1.1	8	N/C	All voltages are in V.	

BC BOARD TRANSISTOR TABLE

	B	C	E		B	C	E
Q3500	1.4	GND	2.1	Q3510	2.1	GND	1.4
Q3501	4.7	4.2	GND	Q3511	2.3	9.0	2.9
Q3502	4.7	0.5	5.0	Q3512	2.5	5.7	1.9
Q3503	3.3	4.7	3.5	Q3513	5.7	9.0	5.0
Q3504	3.3	GND	4.0	Q3514	1.4	GND	2.1
Q3505	4.3	9.0	3.7	Q3515	2.9	9.0	2.3
Q3506	6.2	9.0	5.6	Q3516	2.5	6.0	1.9
Q3508	2.4	9.0	1.8	Q3517	6.0	9.0	5.4
Q3509	1.7	GND	2.3	Q3590	10.2	11.3	9.0

All voltages are in V.

HU BOARD SCHEMATIC DIAGRAM

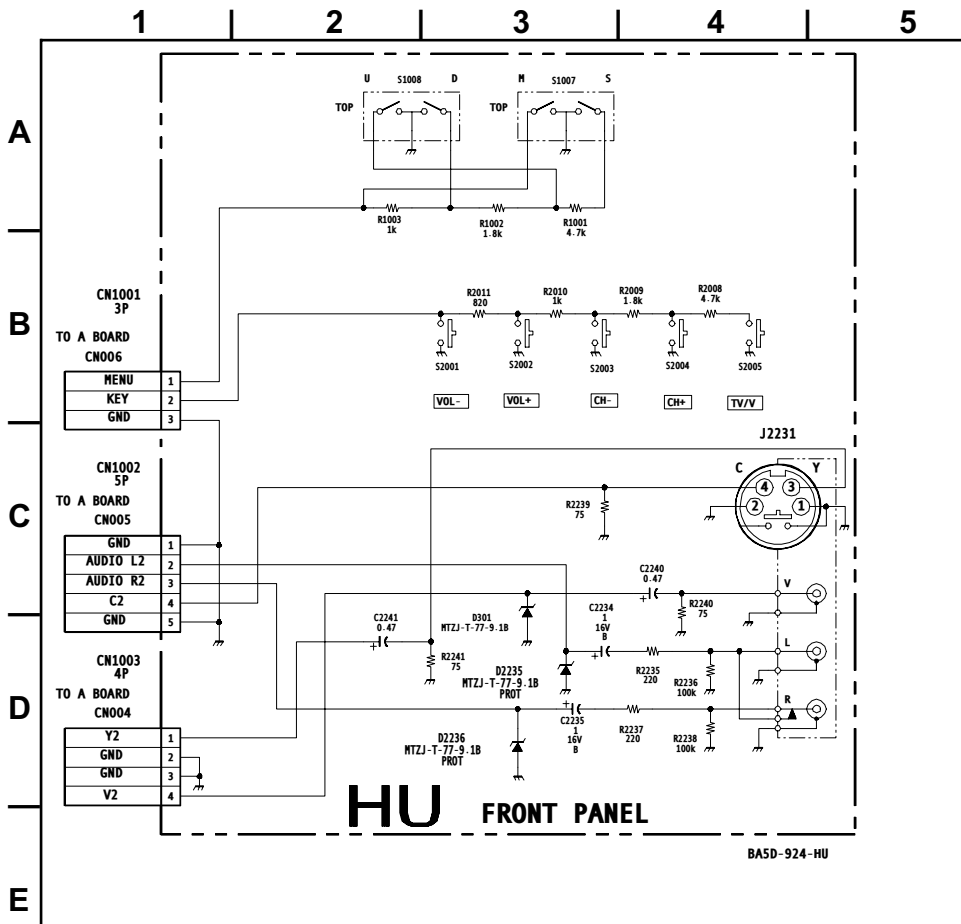

HD

[SPACER] (KV-32FV300/36FV300 ONLY)

HU

[FRONT PANEL]

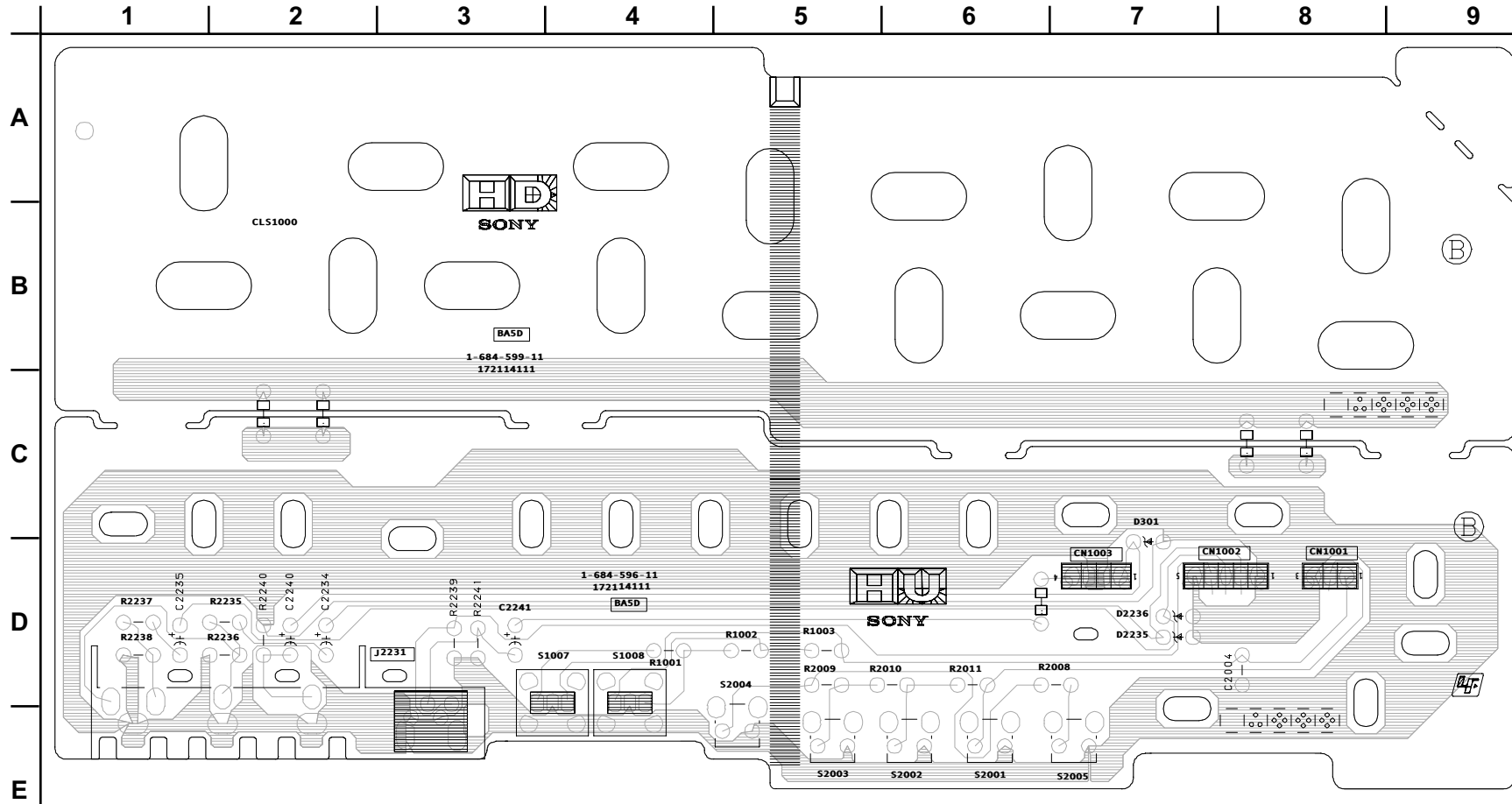

P BOARD SCHEMATIC DIAGRAM

P BOARD IC VOLTAGE LIST

IC3301		11	GND	23	GND	35	0.8
PIN	VOLT	12	GND	24	0.9	36	0.8
1	0.2	13	3.3	25	3.3	37	2.3
2	GND	14	3.2	26	3.5	38	0.8
3	4.5	15	N/C	27	2.0	39	0.8
4	4.5	16	3.3	28	1.7	40	GND
5	3.3	17	1.0	29	GND	41	0.8
6	GND	18	1.0	30	GND	42	0.6
7	N/C	19	0.5	31	GND	IC3390	
8	GND	20	0.5	32	0.6	PIN	VOLT
9	N/C	21	1.6	33	0.0	I	14.0
10	GND	22	1.0	34	3.3	O	9.0
						G	GND

All voltages are in V.

P BOARD TRANSISTOR TABLE

	B	C	E
Q151	8.4	4.5	9.0
Q152	3.9	9.0	3.2
Q3300	2.3	5.0	1.7
Q3301	1.4	5.0	0.8
Q3302	1.4	5.0	0.8
Q3304	3.9	9.0	3.3
Q3305	0.7	0.1	GND
Q3307	0.8	GND	1.5
Q3308	0.7	GND	1.4
Q3309	0.6	GND	1.3
Q3310	0.5	0.6	GND
Q3312	0.2	2.7	GND

All voltages are in V.

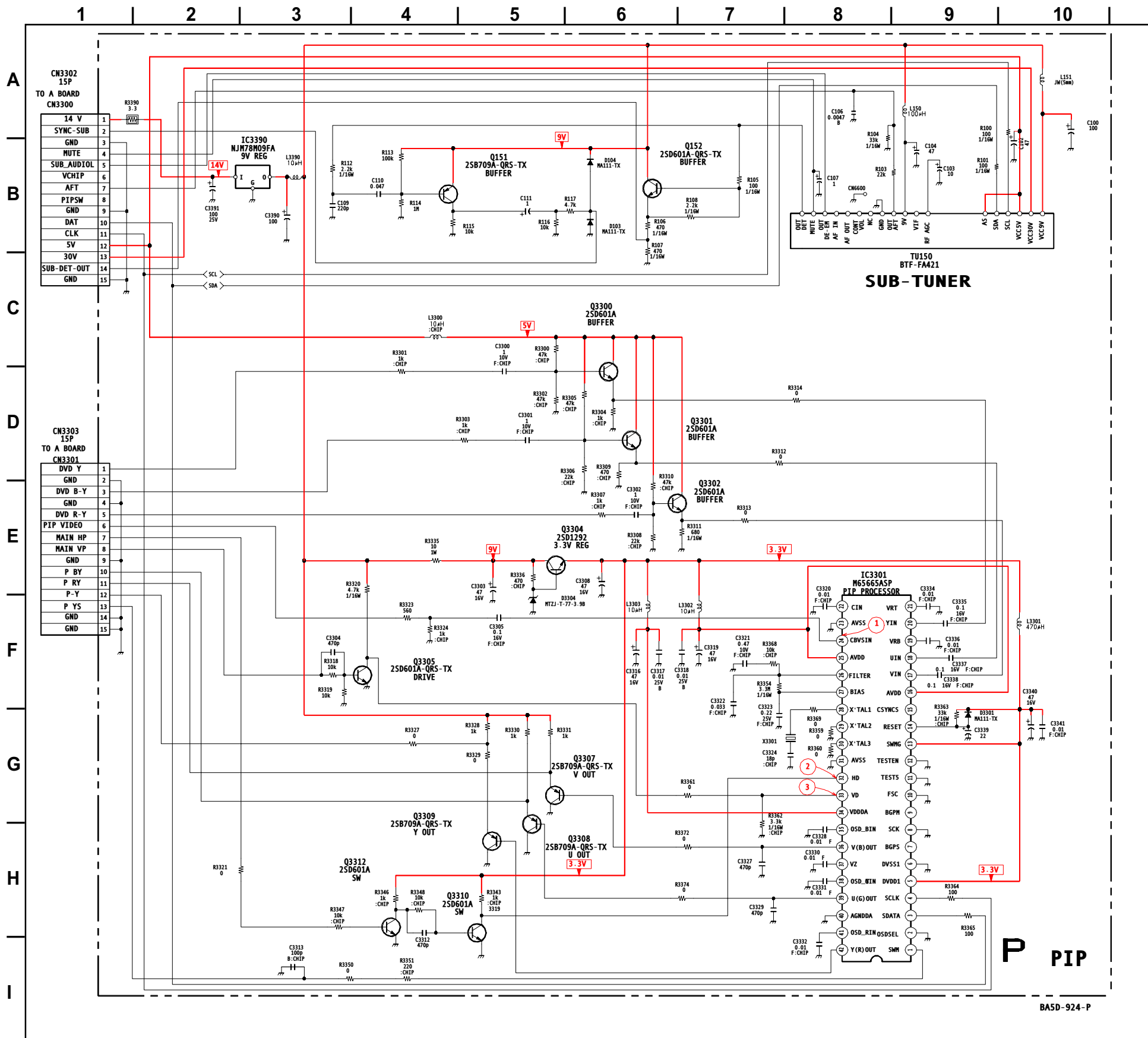

BA5D-924-P

P

[PIP]

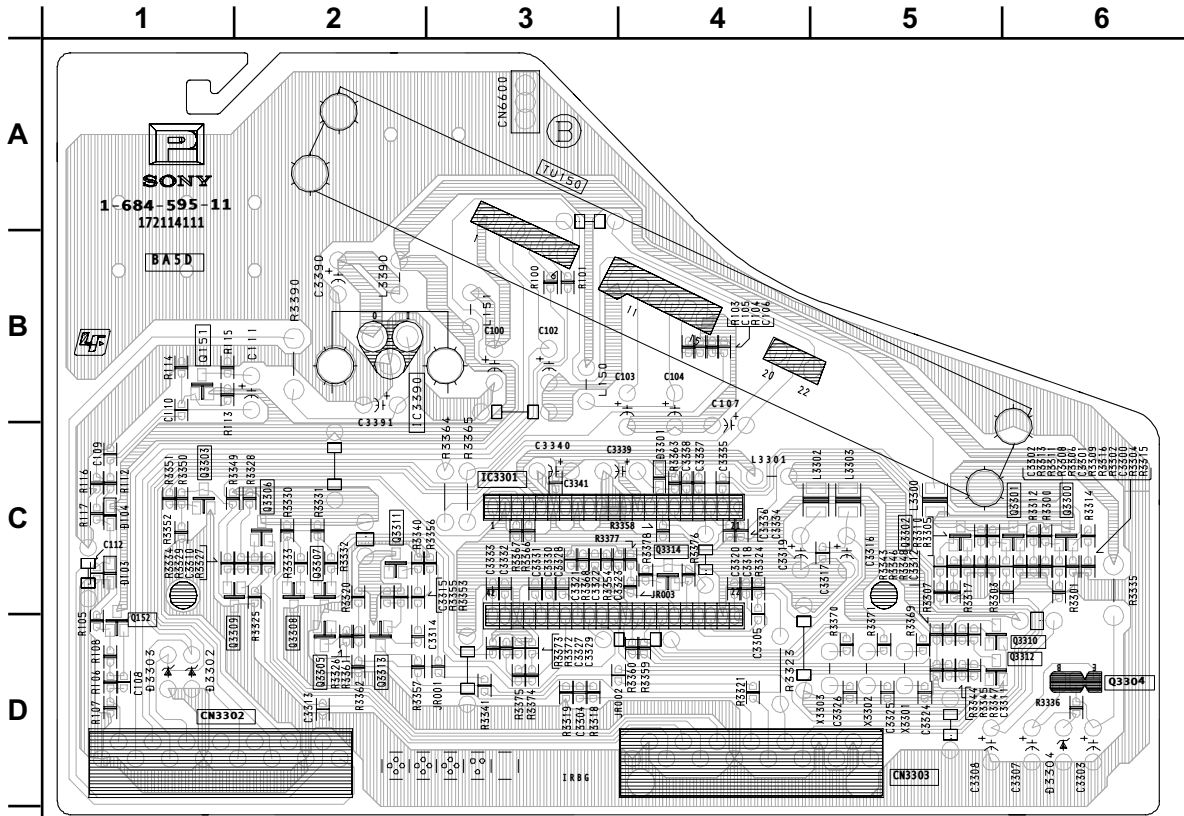

P BOARD WAVEFORM

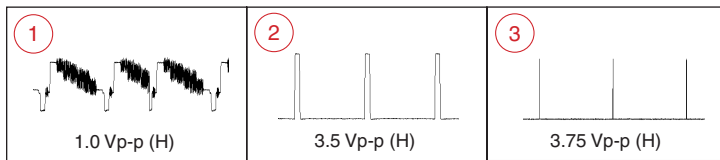

HR BOARD SCHEMATIC DIAGRAM

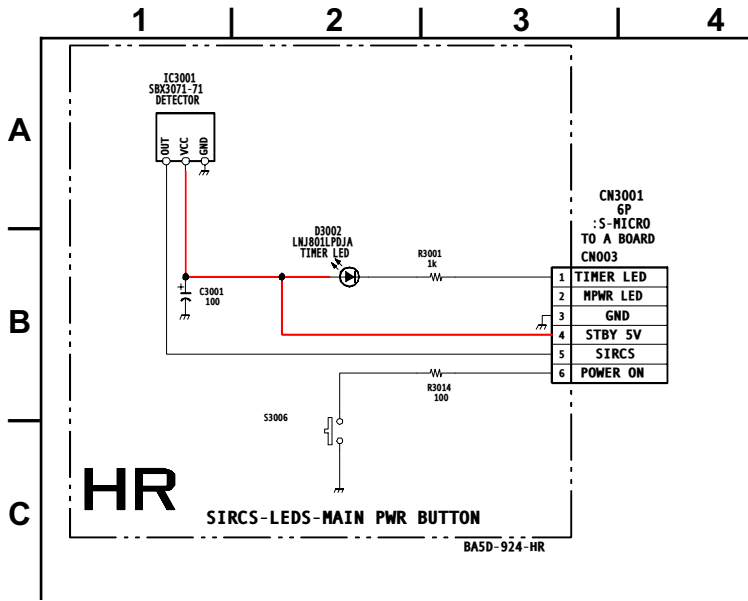

HR BOARD IC VOLTAGE TABLE

IC3001	
PIN	VOLT
1	5.0
2	5.0
3	GND
4	STBY 5V
5	SIRCS
6	POWER ON

All voltages are in V.



[SIRCS, LEDS, MAIN POWER BUTTON]

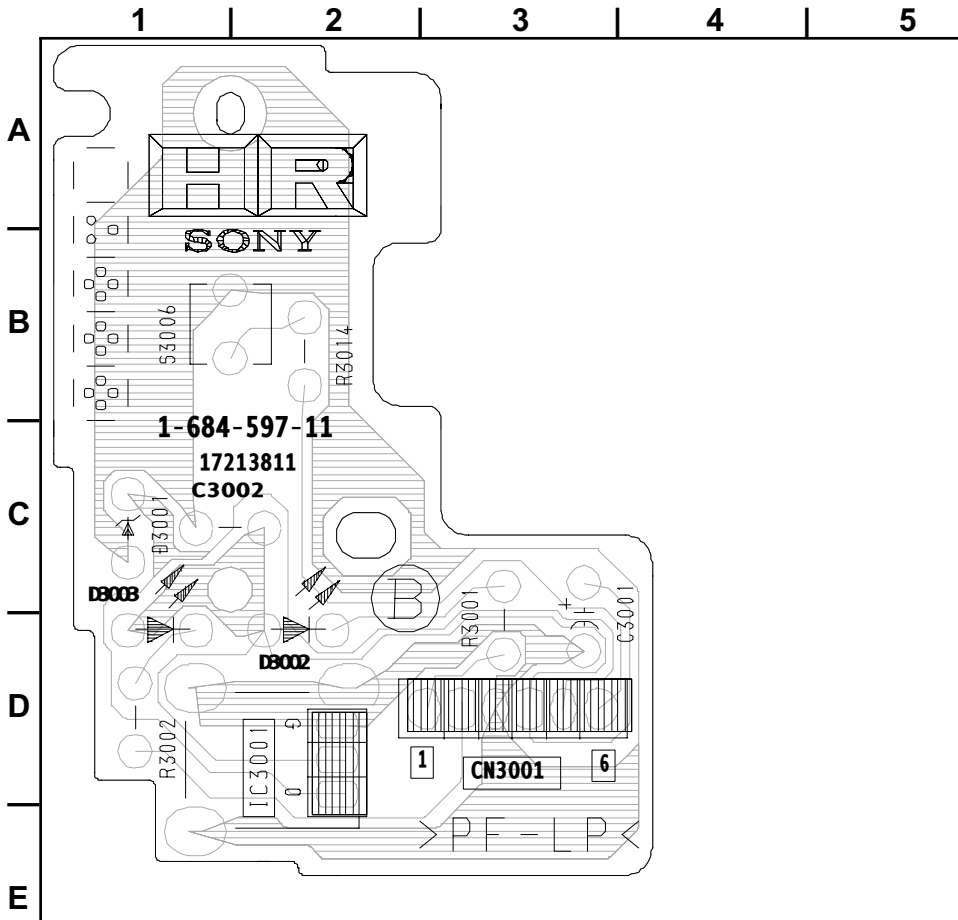

T BOARD SCHEMATIC DIAGRAM (KV-32FV300/36FV300 ONLY)

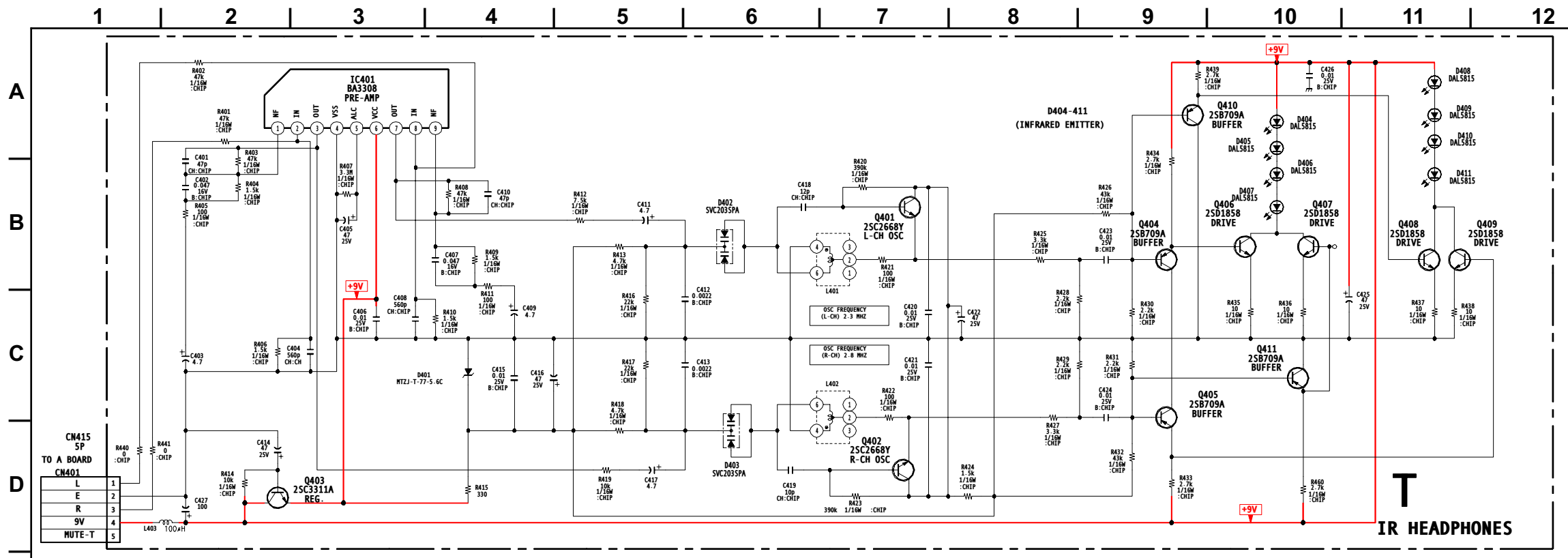

BA5D-924-T

T BOARD IC VOLTAGE TABLE

IC401	
PIN	VOLT
1	1.9
2	0.0
3	1.9
4	0.0
5	1.2
6	9.0
7	1.9
8	0.0
9	1.9

All voltages are in V.

T BOARD TRANSISTOR TABLE

	B	C	E
Q401	0.1	3.4	0.8
Q402	0.1	3.4	0.8
Q403	8.3	9.0	9.0
Q404	1.0	0.0	0.4
Q405	1.0	0.0	0.4
Q406	1.0	2.9	0.5
Q407	1.0	2.9	0.5
Q408	1.0	2.9	0.5
Q409	1.0	2.9	0.5
Q410	1.0	0.0	0.5
Q411	1.0	0.0	0.5

All voltages are in V.

T [IR HEADPHONES] (KV-32FV300/36FV300 ONLY)

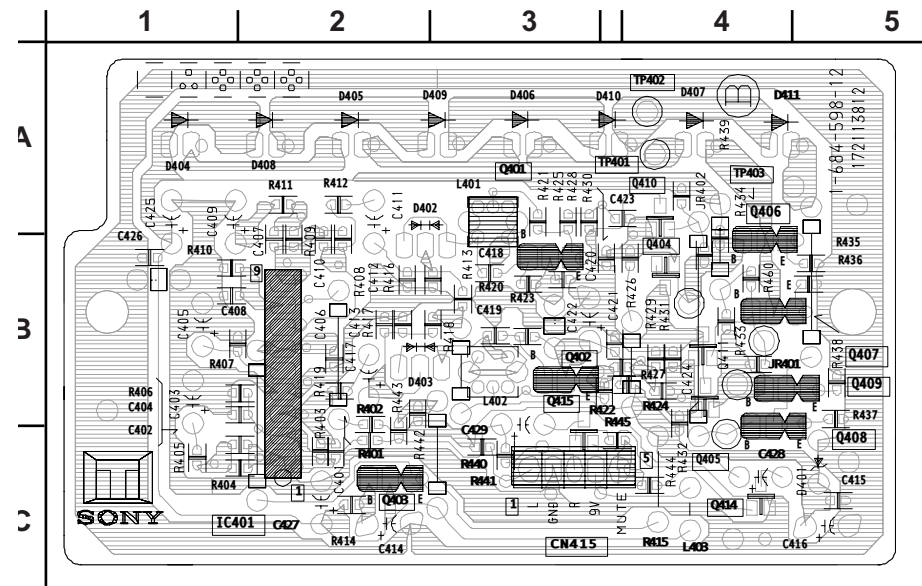

C BOARD SCHEMATIC DIAGRAM

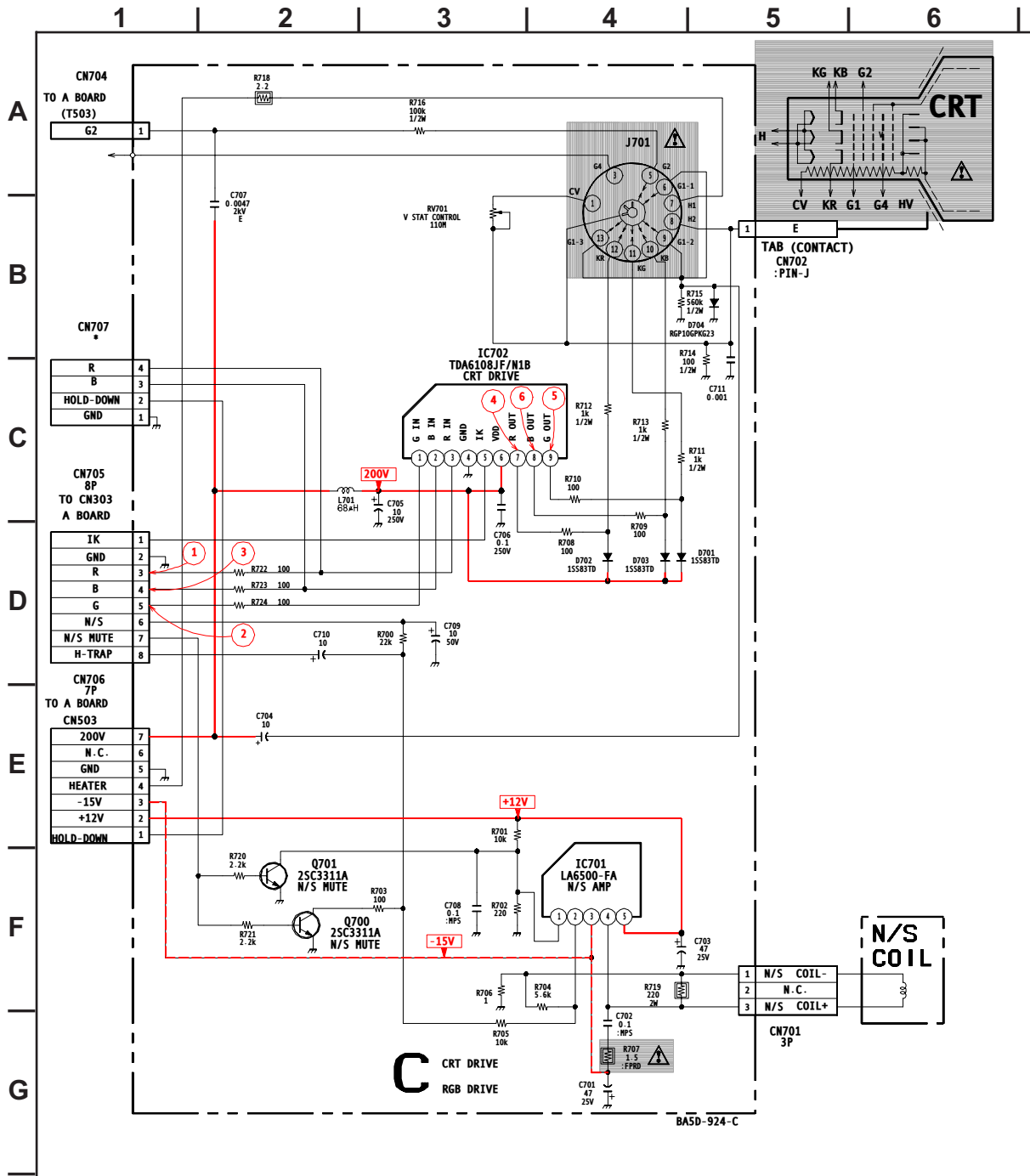

C

[RGB DRIVE, CRT DRIVE]

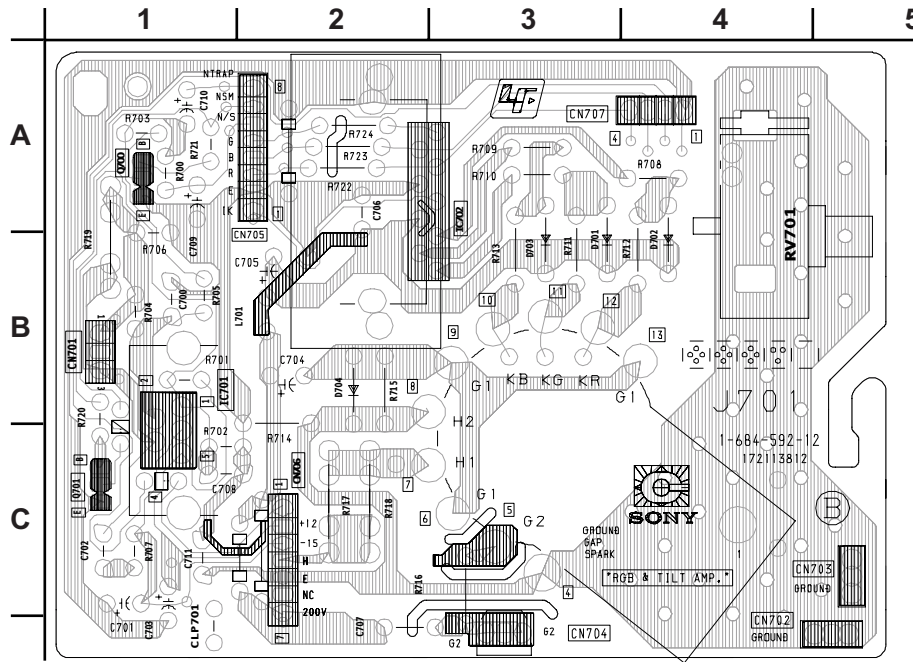

C BOARD IC VOLTAGE TABLE

IC701	
PIN	VOLT
1	0.3
2	0.3
3	-13.0
4	0.5
5	12.0
IC702	
PIN	VOLT
1	2.2
2	2.2
3	2.2
4	GND
5	5.0
6	200.0
7	139.7
8	142.0
9	138.6

All voltages are in V.

C BOARD WAVEFORM

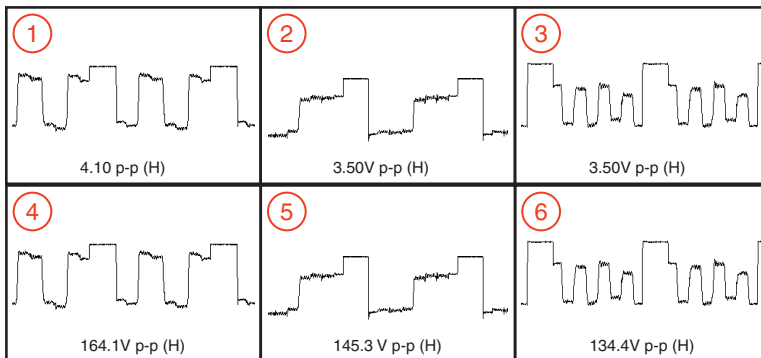

C BOARD MARK(*) LIST

REF. NO.	LOCATION	KV-27FV300 KV-29FV300 KV-32FV300	KV-36FV300
CN707	B-1	#	4P

#: Not Mounted

C BOARD TRANSISTOR TABLE

	B	C	E
Q700	0.3	0.8	GND
Q701	0.3	0.3	GND

All voltages are in V.

V BOARD SCHEMATIC DIAGRAM

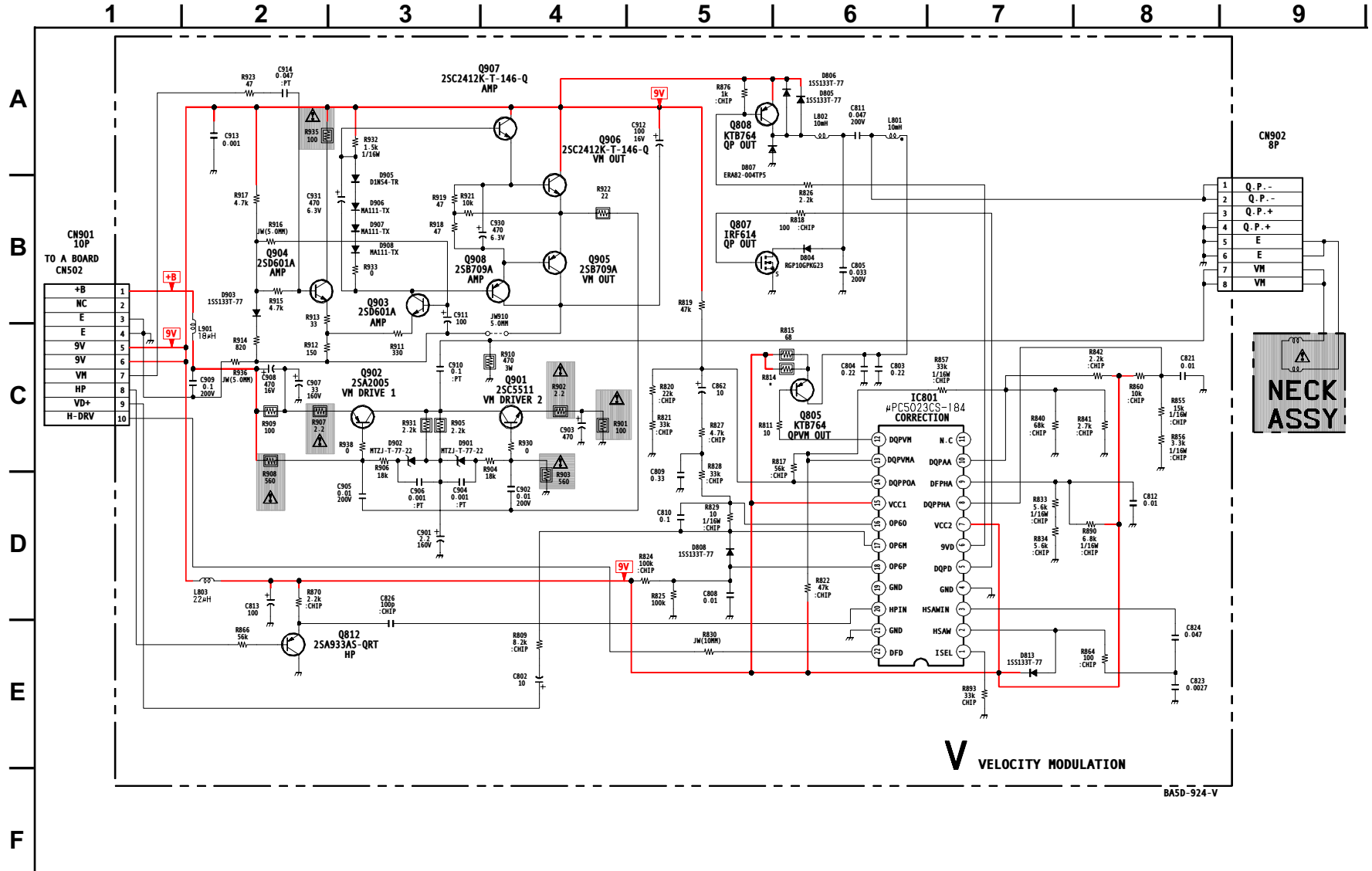

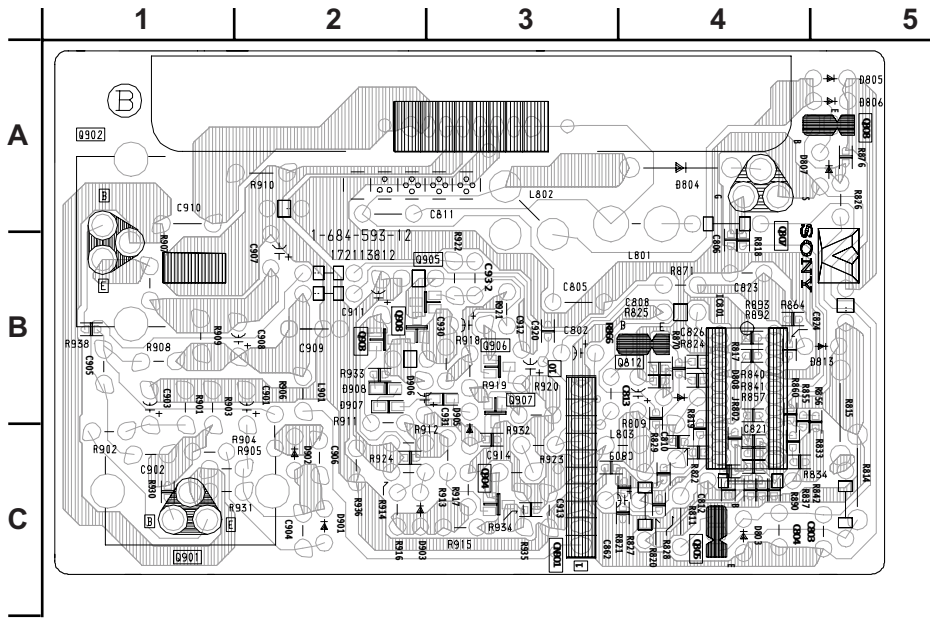

[VELOCITY MODULATION]

**V BOARD MARK(*) LIST**

REF. NO.	LOCATION	KV-27FV300	KV-32FV300
		KV-29FV300	KV-36FV300
R814	C-6	#	68 1W

V BOARD IC VOLTAGE LIST

IC801		11	N/C
PIN	VOLT	12	3.5
1	7.4	13	3.8
2	2.3	14	4.5
3	4.8	15	9.0
4	GND	16	4.6
5	6.3	17	4.6
6	4.5	18	4.5
7	9.0	19	N/C
8	5.8	20	4.8
9	4.6	21	GND
10	4.8	22	0.3

All voltages are in V.

V BOARD TRANSISTOR TABLE

	B	C	E
Q805	3.5	1.8	4.2
Q808	8.6	4.3	9.0
Q812	1.3	GND	2.0
Q901	1.4	67.0	0.8
Q902	132.9	67.0	133.4
Q903	1.2	6.2	1.8
Q904	1.2	8.8	1.8
Q905	7.1	0.0	6.7
Q906	7.4	9.0	7.1
Q907	7.4	9.0	8.1
Q908	6.9	0.0	6.2

	D	G	S
Q807	9.5	6.3	GND

All voltages are in V.

GK BOARD SCHEMATIC DIAGRAM

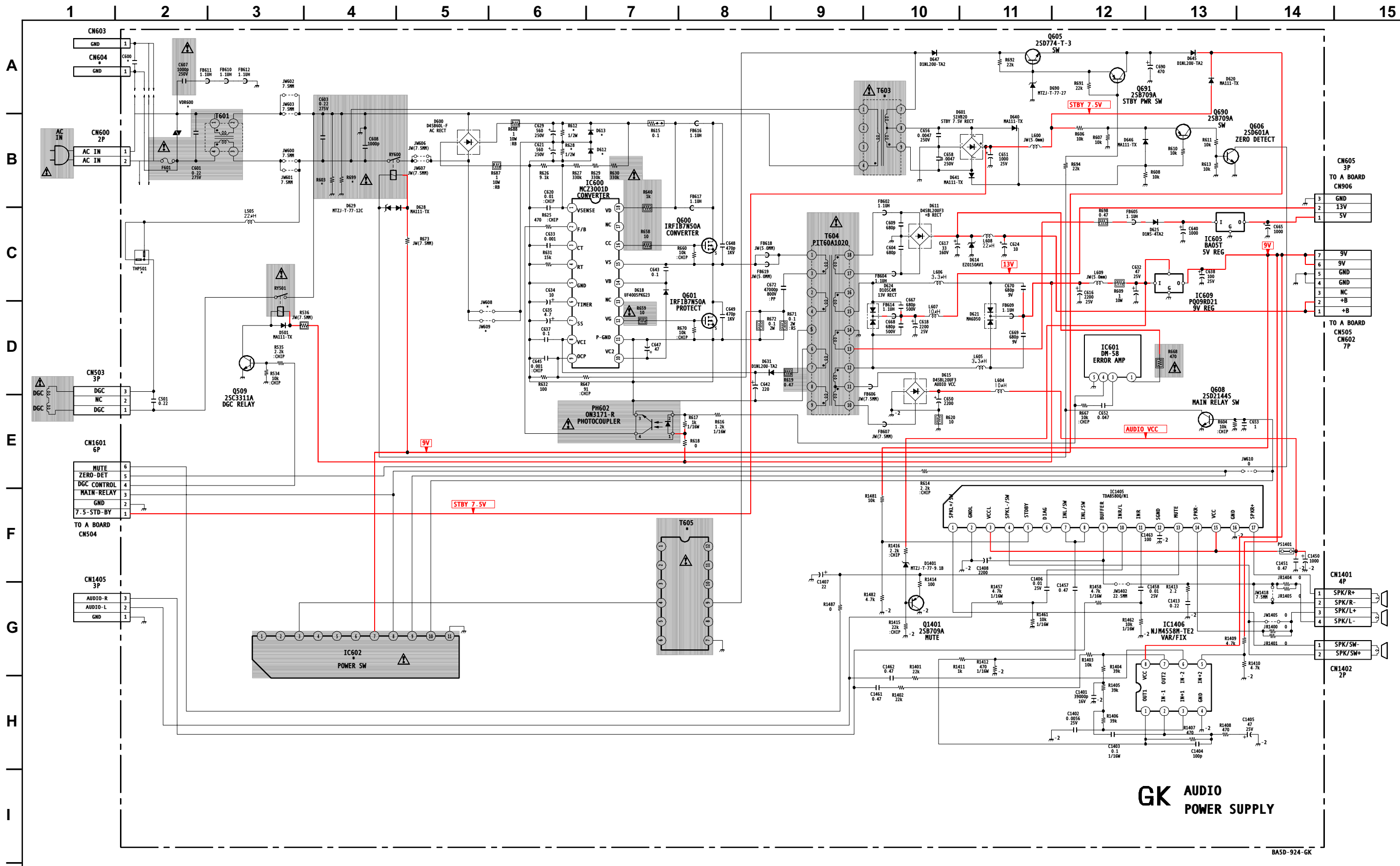

GK AUDIO POWER SUPPLY

BASD-924-GK

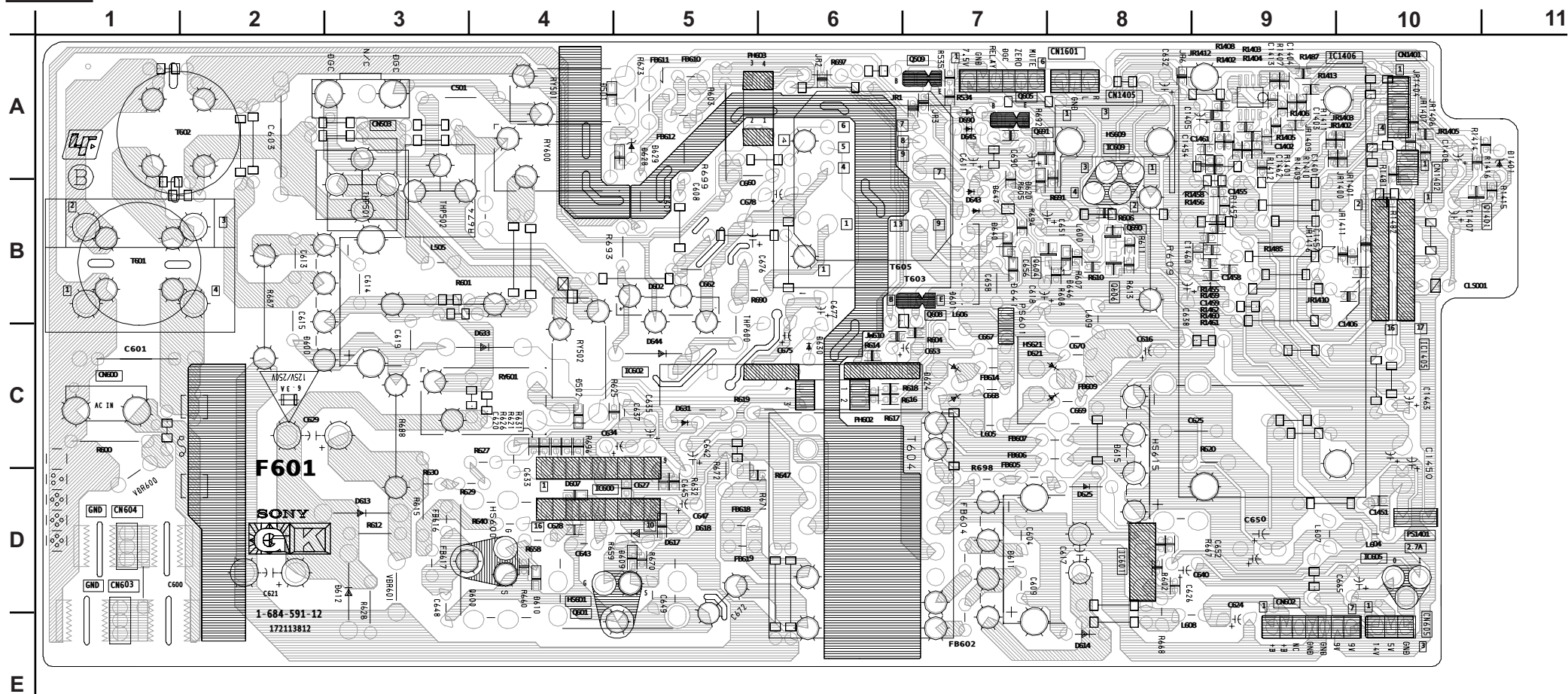

GK BOARD LOCATOR LIST

DIODE		IC	
D1401	A-11	IC1405	C-10
D501	A-5	IC1406	A-10
D600	C-2	IC600	D-5
D601	C-7	IC601	D-8
D611	D-7	IC602	C-5
D612	D-3	IC605	D-10
D613	D-3	IC609	A-8
D614	E-8	TRANSISTOR	
D615	C-8	Q1401	B-11
D618	D-5	Q509	A-7
D620	B-7	Q600	D-4
D621	C-8	Q601	E-4
D624	C-7	Q605	A-7
D625	D-8	Q606	B-8
D628	A-5	Q608	C-7
D629	A-5	Q690	B-8
D631	C-5	Q691	A-8
D640	B-7		
D641	C-7		
D645	A-7		
D646	C-8		
D647	B-7		
D690	A-7		

GK BOARD MARK(*) LIST

REF. NO.	LOCATION	KV-27FV300 KV-29FV300(N) KV-32FV300	KV-29FV300(S)	KV-36FV300
C600	A-1	#	0.0047UF 250V	#
CN604	A-1	1P	#	1P
D612	B-6	8-719-068-00	#	8-719-068-00
D613	B-6	8-719-068-00	#	8-719-068-00
F601	B-2	6.3A/125V	6.3A/250V	6.3A/125V
IC602	G-4	#	#	1-761-541-11
JW608	D-5	7.5MM	#	7.5MM
JW609	D-5	7.5MM	#	7.5MM
R603	B-3	4.7M 1/2W	#	4.7M 1/2W
R612	B-6	#	470K 1/2W	#
R628	B-6	#	470K 1/2W	#
R699	B-3	#	8.2M 1W	#
T603	A-9	1-437-783-11	1-437-784-11	1-437-783-11
T605	F-7	#	#	1-437-785-11
THP501	C-1	1-804-313-11	1-803-540-11	1-803-629-11
VDR600	A-2	1-803-585-11	1-803-967-11	1-803-585-11

#: Not Mounted

GK BOARD IC VOLTAGE LIST

IC600		IC602		IC605		9	11.0
PIN	VOLT	PIN	VOLT	PIN	VOLT		
1	-154.0	1	N/C	I	6.1	10	4.0
2	-155.0	2	N/C	O	5.0	11	3.9
3	-154.8	3	18.5	G	GND	12	GND
4	-154.4	4	N/C	IC609		13	0.4
5	-157.1	5	N/C	PIN	VOLT	14	9.9
6	-156.9	6	N/C	I	10.5	15	14.0
7	-150.2	7	9.0	O	9.0	16	GND
8	-138.8	8	0.0	G	GND	17	9.9
9	-157.1	9	0.6	IC1406			
10	-146.9	10	0.6	PIN	VOLT		
11	-157.1	11	GND	1	10.1		
12	-152.3	IC601		2	GND		
13	N/C	PIN	VOLT	3	14.0		
14	7.0	1	134.6	4	10.1		
15	-2.6	2	N/C	5	2.9		
16	1.9	3	2.4	6	N/C		
17	N/C	4	8.4	7	4.0		
18	156.8	5	GND	8	4.0		

All voltages are in V.



GK BOARD TRANSISTOR TABLE

	B	C	E
Q509	0.3	10.5	GND
Q605	7.6	18.8	7.6
Q606	0.0	0.5	GND
Q608	0.6	0.0	GND
Q690	6.1	0.5	5.9
Q691	6.9	7.6	7.6
Q1401	0.0	GND	0.6

	D	G	S
Q600	156.9	2.5	-2.5
Q601	-2.6	-152.8	-157.4

All voltages are in V.

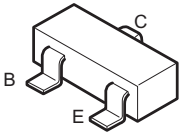
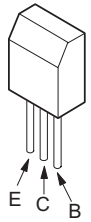
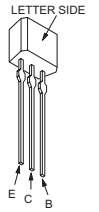
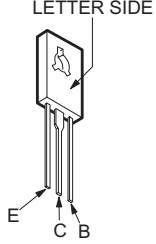
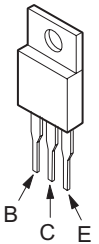
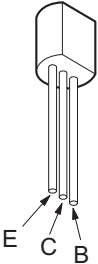
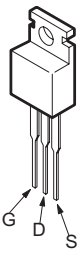
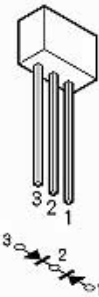
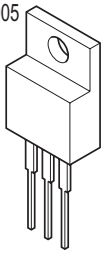
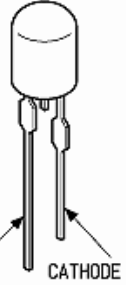
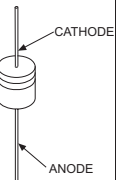
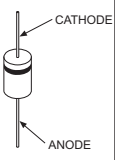
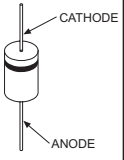
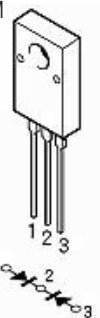
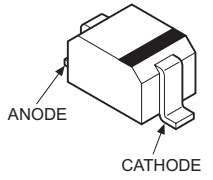
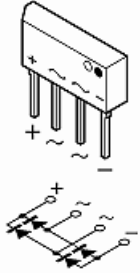
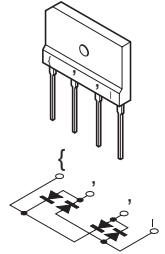
5-4. SEMICONDUCTORS

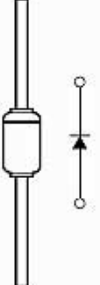
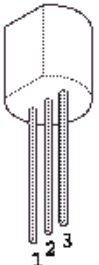
<p>2SB709A-QRS-TX 2SD601A-QRS-TX 2SC2412K-T-146-QR</p> 	<p>2SC3209LK-TP 2SD774-T-34</p> 	<p>2SD1858-Q-TV2 2SC3311A-QRSTA 2SD2144S-TP-UVV</p> 	<p>2SC3840K</p> 	<p>2SC4159-E</p> 
<p>2SA10910-TPE2</p> 	<p>IRF614</p> 	<p>SVC203SPA-AL</p> 	<p>IRFIB7N50A-LF31 2SC5511 2SA2005</p> 	<p>DAL5815</p> 
<p>D1NS4-TA2 D1NS4-TR ERA38-06TP1 ERA82-004TP5 1SS133T-77 MTZJ-T-77-3.3B MTZJ-T-77-3.6B MTZJ-T-77-3.9B MTZJ-T-77-6.2B MTZJ-T-77-6.8B MTZJ-T-77-12C MTZJ-T-77-15B MTZJ-T-77-22</p> 	<p>ERC06-15S MTZJ-T-77-5.1C MTZJ-T-77-5.6C MTZJ-T-77-7.5A MTZJ-T-77-9.1B MTZJ-T-77-10B MTZJ-T-77-30D RGP10-GPKG3 RGP02-17PKG23 RGP15GPKG23</p> 	<p>EL1Z-V1 ERB44-06TP1 ERC04-06SE 1SS83TD 1N4003GA 1N4937/23 GP08DPKG23 PR1004GT RGP10GPKG23 RU4AM-T3</p> 	<p>D10SC4M</p> 	<p>MA111-TX UDZSTE-1710B</p> 
	<p>S1VB20</p> 	<p>D4SB60L-F</p> 	<p>2SC2668-YTP</p> 	<p>MTZJ-T-77-27</p> 
<p>2SA933AS-QRT</p> 				

SECTION 6: EXPLODED VIEWS

Components not identified by a part number or description are not stocked because they are seldom required for routine service.

The component parts of an assembly are indicated by the reference numbers in the far right column of the parts list and within the dotted lines of the diagram.

* Items marked with an asterisk are not stocked since they are seldom required for routine service. Expect some delay when ordering these components.

NOTE: The components identified by shading and  mark are critical for safety. Replace only with part number specified.

NOTE: Les composants identifiés par un trame et une marque  sont critiques pour la sécurité. Ne les remplacer que par une pièce portant le numéro spécifié.

6-1. CHASSIS (KV-27FV300/29FV300 ONLY)

▲	4-046-765-12	SCREW, TAPPING 7+CROWN WASHER
●	4-388-477-01	SCREW(3X16), TAPPING, +BV WASHER
■	7-685-663-79	SCREW 4 X 16 TYPE2
★	7-685-648-79	SCREW 3 X 12 TYPE2
◆	7-685-663-91	SCREW +BVTP 4 X 16 TYPE2 IT-3

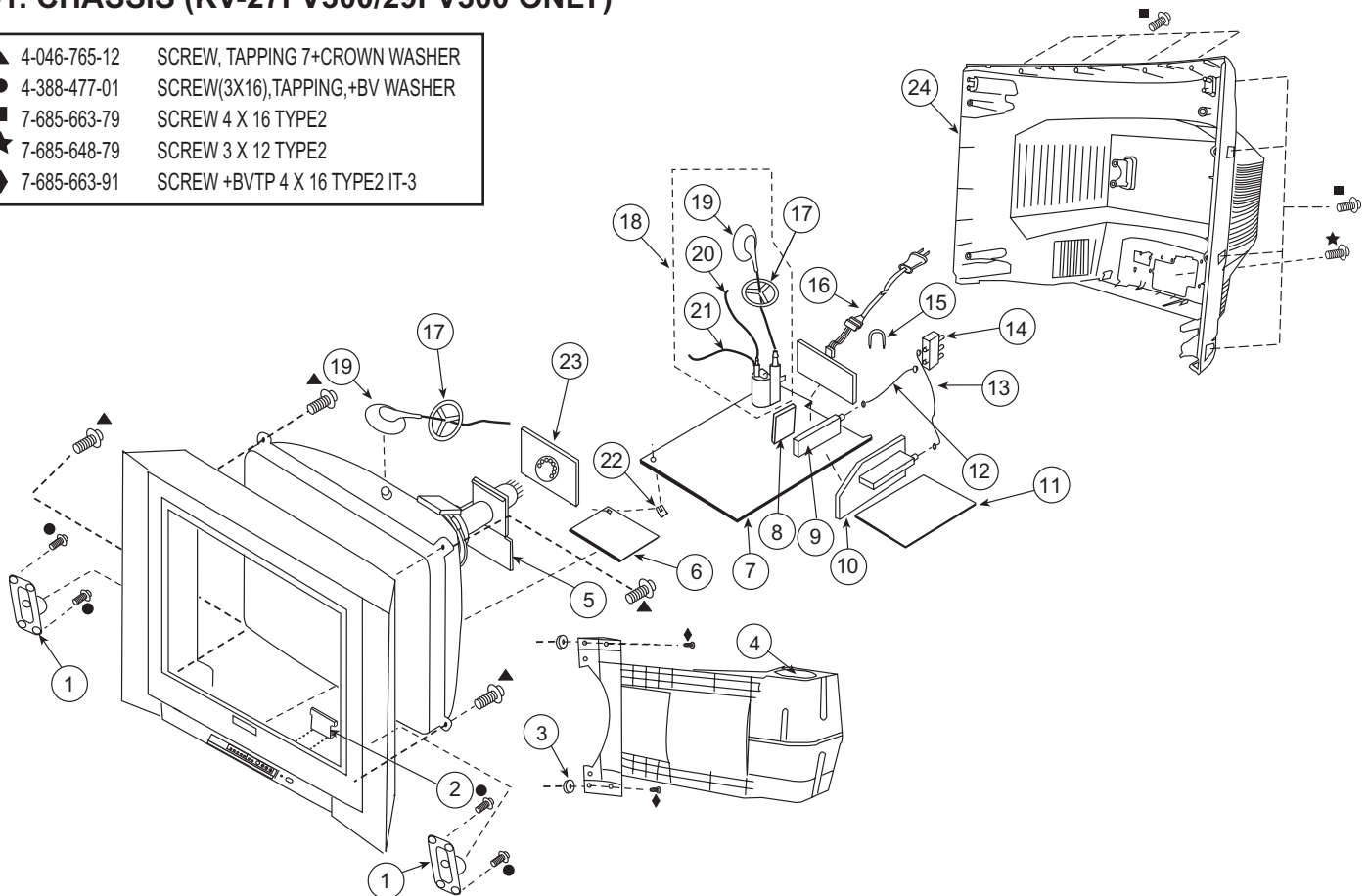

REF. NO.	PART NO.	DESCRIPTION	[Assembly Includes]	REF. NO.	PART NO.	DESCRIPTION	[Assembly Includes]
1	1-825-129-11	SPEAKER (6X12CM)		* 12	1-555-110-00	CABLE, P-P	
* 2	A-1400-459-A	HR (COM) MOUNTED PC BOARD		* 13	1-558-539-21	CABLE, P-P	
3	4-374-745-31	CUSHION (A)		14	1-771-787-12	SWITCH, RF ANTENNA	
4	1-825-128-11	SPEAKER (10CM)		* 15	4-076-951-01	HINGE, PWB	
* 5	A-1400-565-A	V (VAR) MOUNTED PC BOARD		▲ 16	1-791-935-12	CORD, AC POWER(WITH CONNECTOR) KV-27FV300/29FV300 (N)	
* 6	A-1400-451-A	HU MOUNTED PC BOARD		▲ 16	1-769-796-31	CORD, POWER (WITH CONNECTOR) KV-29FV300 (S)	
* 7	A-1300-328-A	A COMPLETE PC BOARD	The high-voltage leads associated with the FBT on this board are not included and must be ordered separately (SEE 19-21).	17	4-084-918-01	HOLDER, HV CABLE	
* 8	A-1400-450-A	BC MOUNTED PC BOARD		▲ 18	1-453-310-11	FBT ASSY NX-4521//X4J4	(19-21)
▲ 9	8-598-593-00	TUNER, FSS BTF-WA421		▲ 19	1-251-374-13	CAP ASSY, HIGH-VOLTAGE	
* 10	A-1400-456-A	P (VAR) MOUNTED PC BOARD		▲ 20	1-900-800-82	WIRE ASSY, FOCUS	
* 11	A-1400-452-A	GK (VAR) MOUNTED PC BOARD KV-27FV300/29FV300 (N)		▲ 21	1-900-803-22	WIRE ASSY, G2 LEAD	
* 11	A-1400-608-A	GK (VAR) MOUNTED PC BOARD KV-29FV300 (S)		* 22	3-696-606-02	HINGE, VI	
				* 23	A-1400-455-A	C (COM) MOUNTED PC BOARD	
				24	4-087-777-01	COVER, REAR	

NOTE: The components identified by shading and \triangle mark are critical for safety. Replace only with part number specified.

NOTE: Les composants identifiés par un triangle et une marque \triangle sont critiques pour la sécurité. Ne les remplacer que par une pièce portant le numéro spécifié.

6-2. PICTURE TUBE (KV-27FV300/29FV300 ONLY)

- ▲ 4-046-765-12 SCREW, TAPPING 7+CROWN WASHER
- 4-388-477-01 SCREW(3X16),TAPPING,+BV WASHER

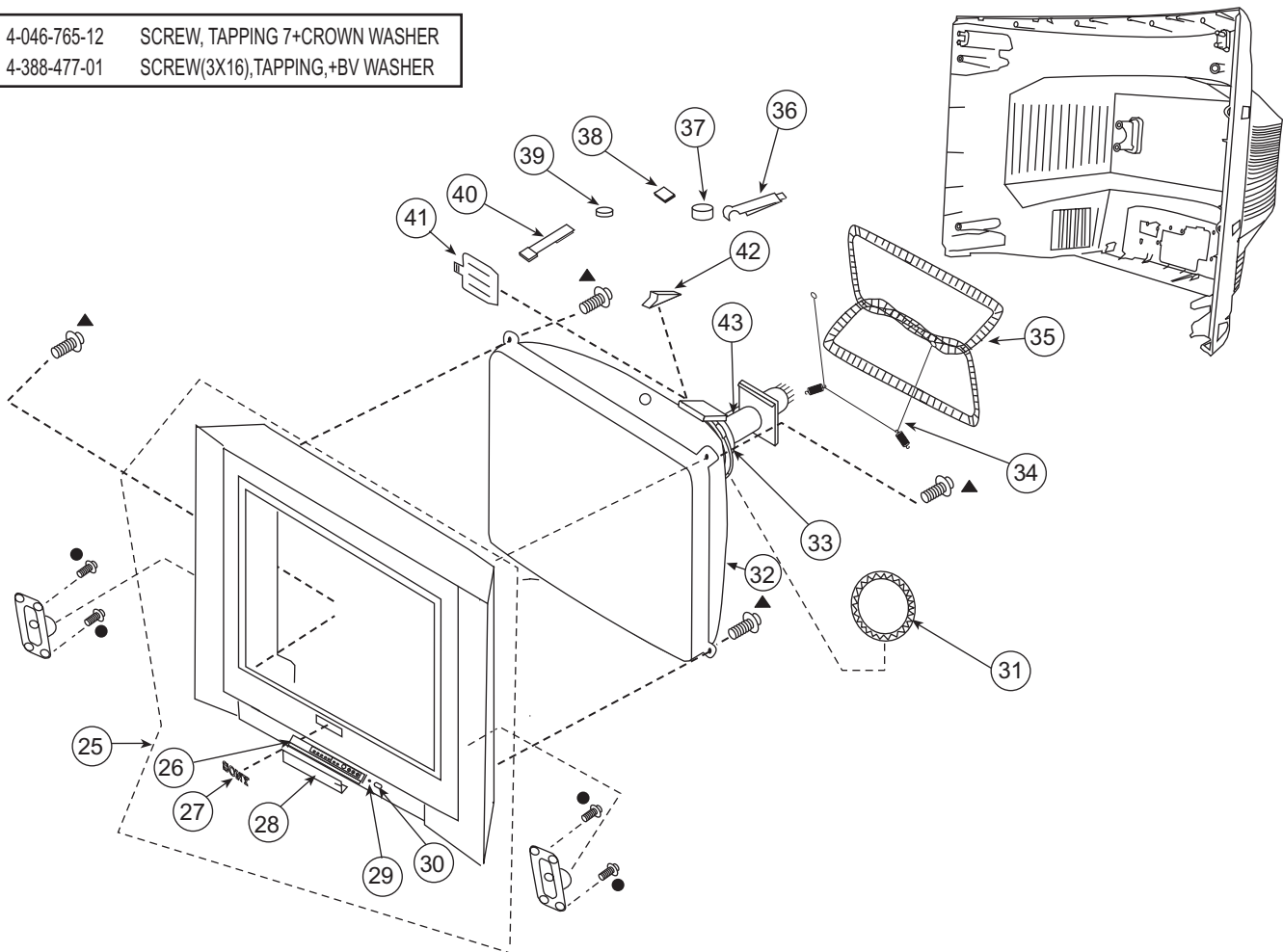

REF. NO.	PART NO.	DESCRIPTION	[Assembly Includes]	REF. NO.	PART NO.	DESCRIPTION	[(Assembly Includes)]
25	X-4040-177-1	BEZNET ASSY	(26-30)	\triangle 35	1-419-156-21	COIL, DEGAUSSING KV-27FV300/29FV300 (N)	
26	4-087-374-01	SPRING, DOOR		\triangle 35	1-419-523-21	COIL, DEGAUSSING KV-29FV300 (S)	
27	4-046-160-21	EMBLEM, SONY (NO.9)		*	36	4-062-970-12	CLIP (29RSN), DGC
28	4-087-375-01	DOOR, CONTROL		37	1-452-094-00	CIRCULAR DISC MAGNET B	
29	4-087-156-01	GUIDE, LIGHT		38	1-452-885-11	MAGNET, LANDING	
30	4-087-150-01	BUTTON, POWER		39	1-452-032-00	MAGNET, DISC	
\triangle 31	1-452-896-11	COIL, NA ROTATION (RT200)		40	4-083-414-01	PIECE A(110), CONV CORRECT	
\triangle 32	8-735-082-05	CRT 29RSN(SDP) KV-27FV300/29FV300 (N)		41	4-081-170-01	PLATE, TLH CORRECTION	
\triangle 32	8-735-083-05	CRT 29RSN(SDP)(SOUTH) KV-29FV300 (S)		42	4-053-005-01	SPACER, DY	
\triangle 33	8-451-494-41	DY Y29RSA-V		\triangle 43	8-453-011-11	NECK ASSEMBLY NA299-M	
34	4-036-329-01	SPRING (B), TENSION					

NOTE: The components identified by shading and  mark are critical for safety. Replace only with part number specified.

NOTE: Les composants identifiés par un trame et une marque  sont critiques pour la sécurité. Ne les remplacer que par une pièce portant le numéro spécifié.

6-3. CHASSIS (KV-32FV300 ONLY)

▲	4-046-765-12	SCREW, TAPPING 7+CROWN WASHER
●	4-388-477-01	SCREW(3X16),TAPPING,+BV WASHER
■	7-685-663-79	SCREW 4 X 16 TYPE2
★	7-685-648-79	SCREW 3 X 12 TYPE2
◆	7-685-663-91	SCREW +BVTP 4 X 16 TYPE2 IT-3

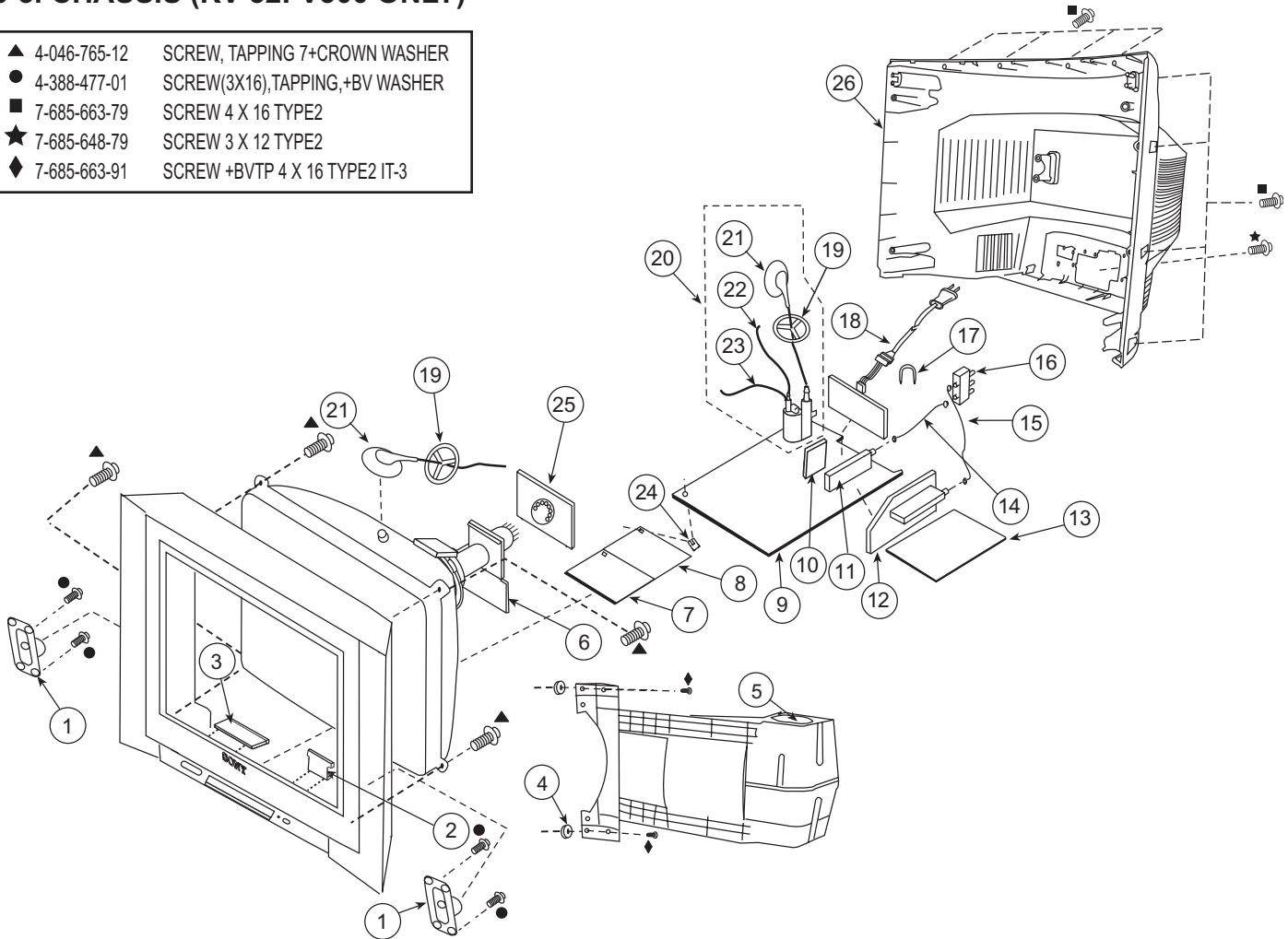

REF. NO.	PART NO.	DESCRIPTION	[Assembly Includes]	REF. NO.	PART NO.	DESCRIPTION	[(Assembly Includes)]
1	1-825-129-11	SPEAKER (6X12CM)		* 13	A-1400-452-A	GK (VAR) MOUNTED PC BOARD	
* 2	A-1400-459-A	HR (COM) MOUNTED PC BOARD		* 14	1-555-110-00	CABLE, P-P	
* 3	A-1400-460-A	T MOUNTED PC BOARD		* 15	1-558-539-21	CABLE, P-P	
4	4-374-745-31	CUSHION (A)		16	1-771-787-12	SWITCH, RF ANTENNA	
5	1-825-128-11	SPEAKER (10CM)		* 17	4-076-951-01	HINGE, PWB	
* 6	A-1400-461-A	V (VAR) MOUNTED PC BOARD		▲ 18	1-791-935-12	CORD, AC POWER(WITH CONNECTOR)	
* 7	A-1400-451-A	HU MOUNTED PC BOARD		19	4-084-918-01	HOLDER, HV CABLE	
* 8	A-1400-607-A	HD MOUNTED PC BOARD		▲ 20	1-453-338-31	FBT ASSY NX-4600//X4C4	(21-23)
* 9	A-1300-278-A	A COMPLETE PC BOARD	The high-voltage leads associated with the FBT on this board are not included and must be ordered separately (SEE 21-23).	▲ 21	1-251-715-22	CAP ASSY, HIGH-VOLTAGE	
* 10	A-1400-450-A	BC MOUNTED PC BOARD		▲ 22	1-900-805-19	WIRE ASSY, FOCUS HV	
▲ 11	8-598-593-00	TUNER, FSS BTF-WA421		▲ 23	1-900-805-22	CONNECTOR ASSY, G2 HV	
* 12	A-1400-456-A	P (VAR) MOUNTED PC BOARD		* 24	3-696-606-02	HINGE, VI	
				* 25	A-1400-455-A	C (COM) MOUNTED PC BOARD	
				26	4-087-878-01	COVER, REAR	

NOTE: The components identified by shading and \triangle mark are critical for safety. Replace only with part number specified.

NOTE: Les composants identifiés par un triangle et une marque \triangle sont critiques pour la sécurité. Ne les remplacer que par une pièce portant le numéro spécifié.

6-4. PICTURE TUBE (KV-32FV300 ONLY)

- ▲ 4-046-765-12 SCREW, TAPPING 7+CROWN WASHER
- 4-388-477-01 SCREW(3X16),TAPPING,+BV WASHER

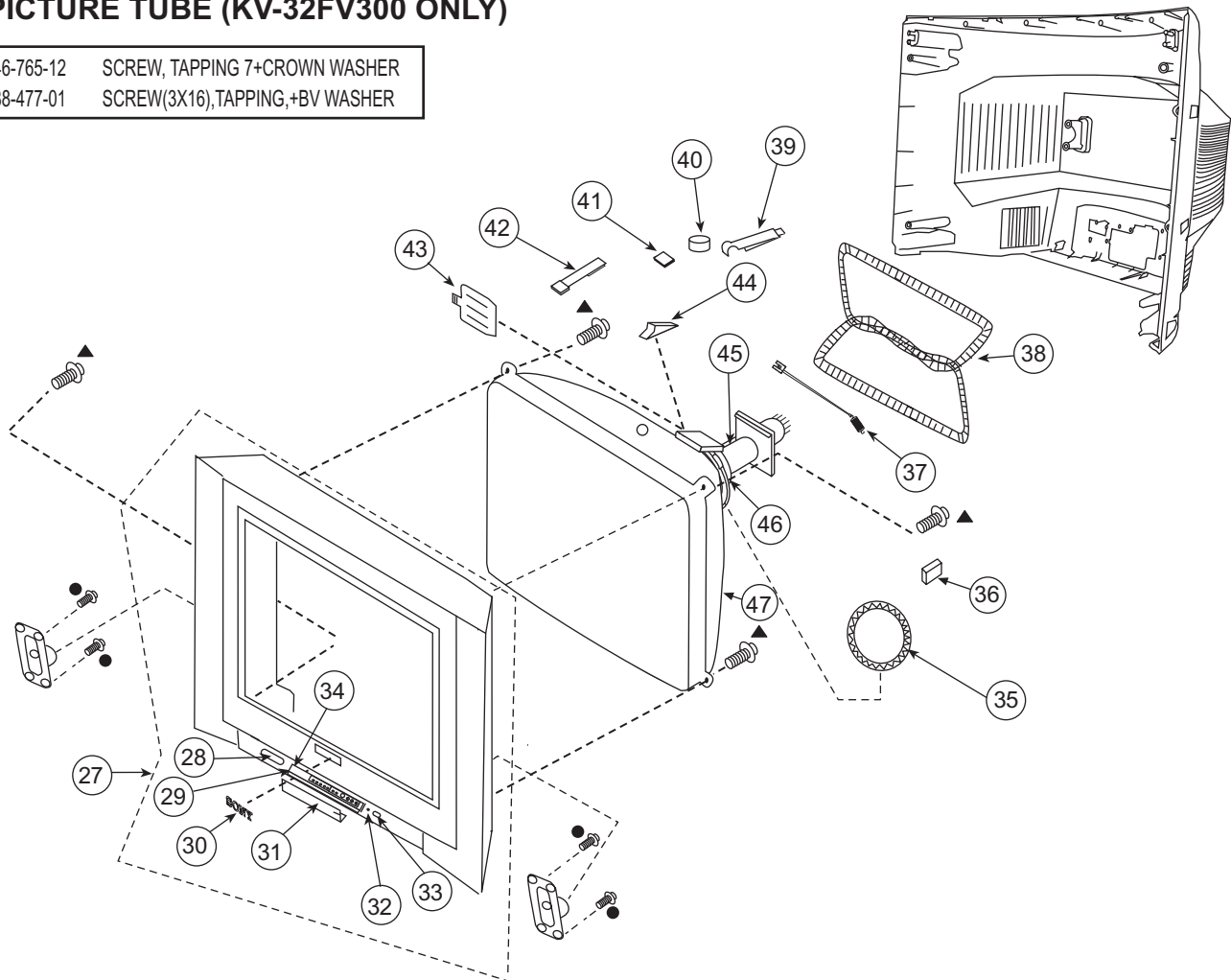

REF. NO.	PART NO.	DESCRIPTION	[Assembly Includes]	REF. NO.	PART NO.	DESCRIPTION	[(Assembly Includes)]
27	X-4040-115-1	BEZNET ASSY	(28-34)	\triangle 38	1-428-988-11	DEGAUSSING COIL (32" 120V)	
28	4-086-887-01	PANEL, IR		39	4-065-895-11	HOLDER, DGC	
29	4-087-374-01	SPRING, DOOR		40	1-452-032-00	MAGNET, DISC	
30	4-046-160-21	EMBLEM, SONY (NO.9)		41	1-452-885-11	MAGNET, LANDING	
31	4-087-375-01	DOOR, CONTROL		42	4-083-414-01	PIECE A(110), CONV CORRECT	
32	4-087-156-01	GUIDE, LIGHT		43	4-081-170-01	PLATE, TLH CORRECTION	
33	4-087-150-01	BUTTON, POWER		44	4-053-005-01	SPACER, DY	
34	4-036-880-11	DAMPER		\triangle 45	8-453-007-41	NECK ASSEMBLY NA324-M4	
\triangle 35	1-452-896-11	COIL, NA ROTATION (RT200)		\triangle 46	8-451-499-41	DY Y34RSA-V	
* 36	4-078-952-01	CUSHION, 20MM X 20MM		\triangle 47	8-735-066-05	CRT 34RSN(SDP)	
37	4-082-641-01	SPRING 45MM					

NOTE: The components identified by shading and  mark are critical for safety. Replace only with part number specified.

NOTE: Les composants identifiés par un trame et une marque  sont critiques pour la sécurité. Ne les remplacer que par une pièce portant le numero specifie.

6-5. CHASSIS (KV-36FV300 ONLY)

▲	4-046-765-12	SCREW, TAPPING 7+CROWN WASHER
●	4-388-477-01	SCREW(3X16), TAPPING, +BV WASHER
■	7-685-663-79	SCREW 4 X 16 TYPE2
★	7-685-648-79	SCREW 3 X 12 TYPE2
◆	7-685-663-91	SCREW +BVTP 4 X 16 TYPE2 IT-3

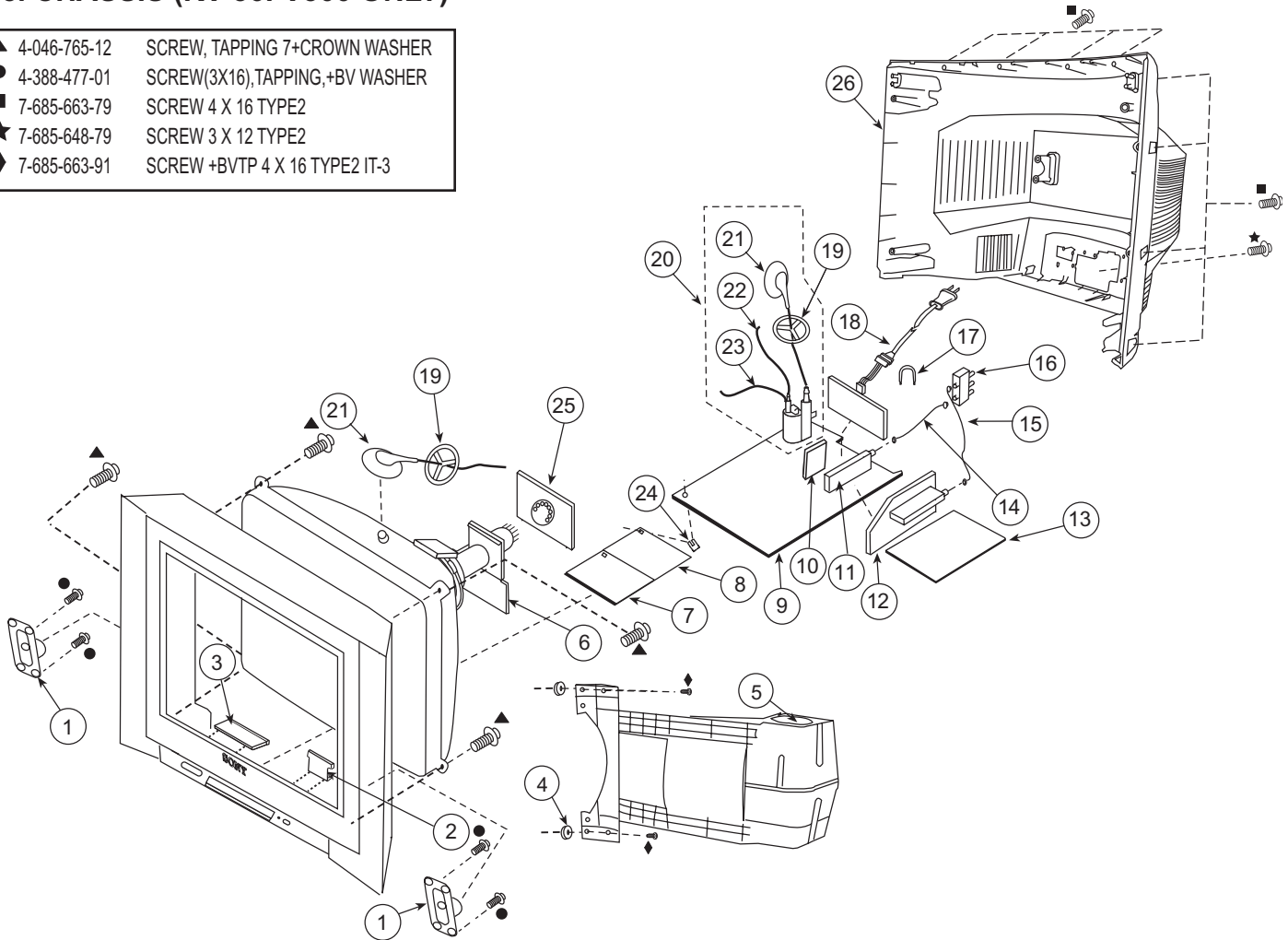

REF. NO.	PART NO.	DESCRIPTION	[Assembly Includes]	REF. NO.	PART NO.	DESCRIPTION	[(Assembly Includes)]
1	1-825-129-11	SPEAKER (6X12CM)		* 13	A-1400-583-A	GK (VAR) MOUNTED PC BOARD	
* 2	A-1400-459-A	HR (COM) MOUNTED PC BOARD		* 14	1-555-110-00	CABLE, P-P	
* 3	A-1400-460-A	T MOUNTED PC BOARD		* 15	1-558-539-21	CABLE, P-P	
4	4-374-745-31	CUSHION (A)		16	1-771-787-12	SWITCH, RF ANTENNA	
5	1-825-128-11	SPEAKER (10CM)		* 17	4-076-951-01	HINGE, PWB	
* 6	A-1400-581-A	V (VAR) MOUNTED PC BOARD		▲ 18	1-791-935-12	CORD, AC POWER(WITH CONNECTOR)	
* 7	A-1400-451-A	HU MOUNTED PC BOARD		19	3-704-372-71	HOLDER, HV CABLE	
* 8	A-1400-607-A	HD MOUNTED PC BOARD		▲ 20	1-453-338-21	FBT ASSY NX-4600//X4C4	(21-23)
* 9	A-1300-336-A	A COMPLETE PC BOARD		▲ 21	1-251-715-32	CAP ASSY, HIGH-VOLTAGE	
		The high-voltage leads associated with the FBT on this board are not included and must be ordered separately (SEE 21-23).		▲ 22	1-900-805-19	WIRE ASSY, FOCUS HV	
* 10	A-1400-450-A	BC MOUNTED PC BOARD		▲ 23	1-900-805-22	CONNECTOR ASSY, G2 HV	
▲ 11	8-598-593-00	TUNER, FSS BTF-WA421		* 24	3-696-606-02	HINGE, VI	
* 12	A-1400-456-A	P (VAR) MOUNTED PC BOARD		* 25	A-1400-580-A	C (VAR) MOUNTED PC BOARD	
				26	4-086-697-01	COVER, REAR	

NOTE: The components identified by shading and \triangle mark are critical for safety. Replace only with part number specified.

NOTE: Les composants identifiés par un triangle et une marque \triangle sont critiques pour la sécurité. Ne les remplacer que par une pièce portant le numéro spécifié.

6-6. PICTURE TUBE (KV-36FV300 ONLY)

- ▲ 4-046-765-12 SCREW, TAPPING 7+CROWN WASHER
- 4-388-477-01 SCREW(3X16),TAPPING,+BV WASHER

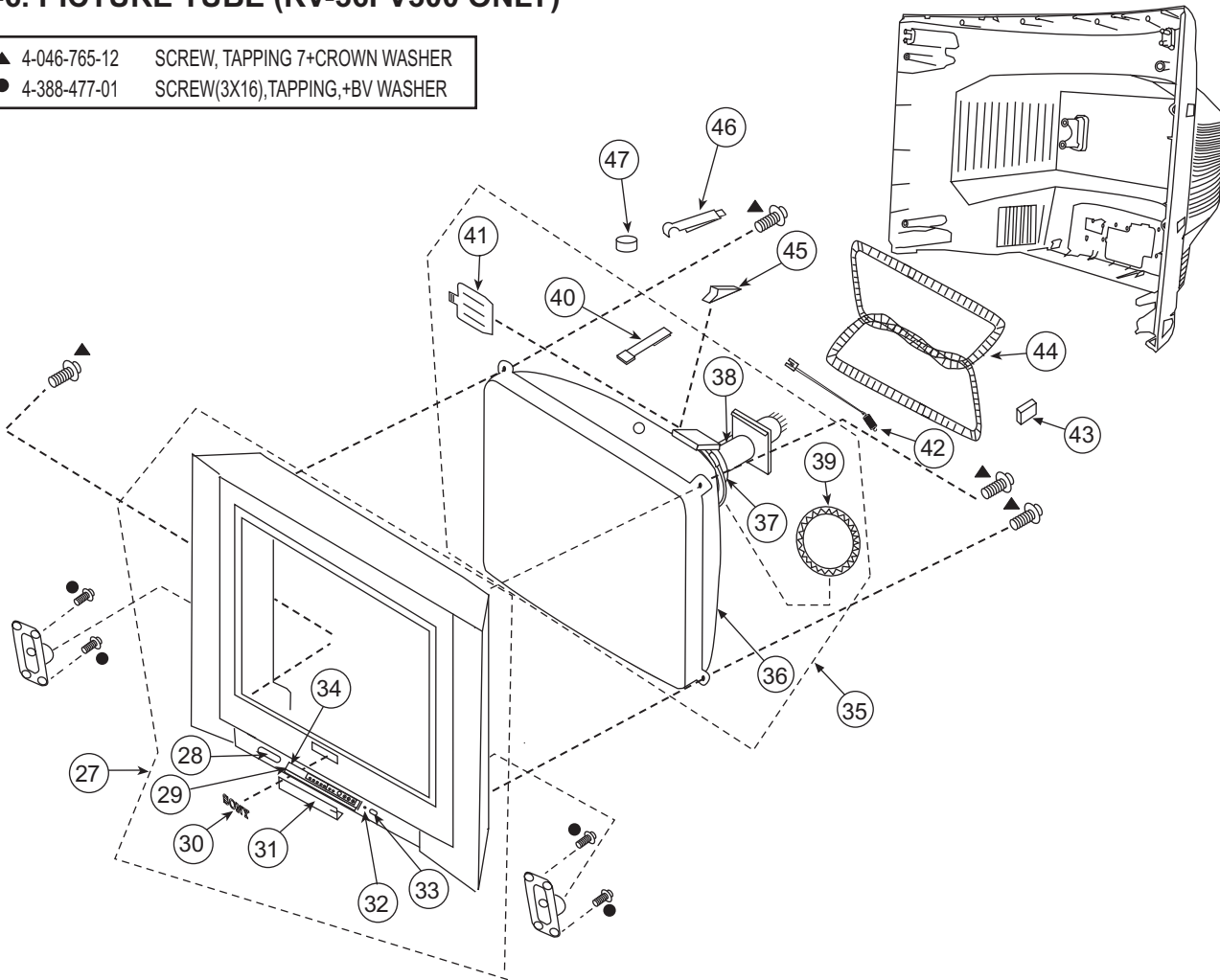

REF. NO.	PART NO.	DESCRIPTION	[Assembly Includes]	REF. NO.	PART NO.	DESCRIPTION	[(Assembly Includes)]
27	X-4039-673-1	BEZNET ASSY	(27-34)	\triangle 37	1-451-531-11	DY	
28	4-086-887-01	PANEL, IR		\triangle 37	8-451-506-11	KV-36FV300 (U) (CND) DY Y38RSA-X	
29	4-087-374-01	SPRING, DOOR		\triangle 38	8-453-007-41	NECK ASSEMBLY, NA324-M4	
30	4-046-160-21	EMBLEM, SONY (NO.9)		\triangle 39	1-452-896-11	COIL, NA ROTATION (RT200)	
31	4-087-375-01	DOOR, CONTROL		40	4-062-047-02	PIECE A(110), CONV CORRECT	
32	4-087-156-01	GUIDE, LIGHT		41	4-081-170-01	PLATE, TLH CORRECTION	
33	4-087-150-01	BUTTON, POWER		42	4-082-641-01	SPRING, 45MM	
34	4-036-880-11	DAMPER		*	4-078-952-01	CUSHION, 20MM X 20MM	
\triangle 35	8-735-048-61	ITC 38RSN-A1	(36-41)	\triangle 44	1-428-987-11	DEGAUSSING COIL (36" 120V)	
\triangle 35	8-735-081-61	ITC 38RSN-A1M	(36-41)	45	4-053-005-01	SPACER, DY	
\triangle 36	8-735-045-05	CRT 38RSN/F73504801		46	4-065-895-11	HOLDER, DGC	
\triangle 36	8-735-081-05	CRT 38RSN		47	1-452-032-11	MAGNET,DISC	
		KV-36FV300 (U) (CND)					
		KV-36FV300 (HAWAII)					

SECTION 7: ELECTRICAL PARTS LIST

NOTE: The components identified by shading and  mark are critical for safety. Replace only with part number specified.

NOTE: Les composants identifiés par un trame et une marque  sont critiques pour la sécurité. Ne les remplacer que par une pièce portant le numéro spécifié.

The components in this manual identified by the following symbol:  indicate parts that have been carefully factory-selected to satisfy regulations regarding X-ray radiation For each set.

Should replacement be required for one of these components, replace only with the value originally used.











* Items marked with an asterisk are not stocked since they are seldom required for routine service. Expect some delay when ordering these components.

RESISTORS

- All resistors are in ohms
- F : nonflammable
- All variable and adjustable resistors have characteristic curve B, unless otherwise noted.





When ordering parts by reference number, please include the board name.

REF. NO.	PART NO.	DESCRIPTION	VALUES	REF. NO.	PART NO.	DESCRIPTION	VALUES
							
*	A-1300-278-A	A BOARD, COMPLETE (KV-32FV300 ONLY)		C006	1-162-964-11	CERAMIC CHIP	0.001µF 10% 50V
*	A-1300-328-A	A BOARD, COMPLETE (KV-27FV300/29FV300 ONLY)		C007	1-164-230-11	CERAMIC CHIP	220pF 5% 50V
*	A-1300-336-A	A BOARD, COMPLETE (KV-36FV300 ONLY)		C008	1-126-960-11	ELECT	1µF 20% 50V
	4-382-854-11	SCREW (M3X10), P, SW (+)		C009	1-162-964-11	CERAMIC CHIP	0.001µF 10% 50V
The high-voltage leads associated with the FBT on the A board are not included and must be ordered separately. Order the following leads when requesting this A board:				C014	1-162-919-11	CERAMIC CHIP	22pF 5% 50V
	1-251-374-13	HV CAP ASSY		C015	1-162-919-11	CERAMIC CHIP	22pF 5% 50V
	1-900-800-82	FOCUS LEAD		C016	1-126-941-11	ELECT	470µF 20% 25V
	1-900-803-22	G2 LEAD (KV-27FV300/29FV300 ONLY)		C017	1-162-966-11	CERAMIC CHIP	0.0022µF 10% 50V
	1-251-715-22	HV CAP ASSY		C018	1-164-230-11	CERAMIC CHIP	220pF 5% 50V
	1-900-805-19	FOCUS LEAD		C020	1-164-230-11	CERAMIC CHIP	220pF 5% 50V
	1-900-805-22	G2 LEAD (KV-32FV300 ONLY)		C026	1-164-230-11	CERAMIC CHIP	220pF 5% 50V
	1-251-715-32	HV CAP ASSY		C027	1-162-964-11	CERAMIC CHIP	0.001µF 10% 50V
	1-900-805-19	FOCUS LEAD		C028	1-162-964-11	CERAMIC CHIP	0.001µF 10% 50V
	1-900-805-22	G2 LEAD (KV-36FV300 ONLY)		C029	1-126-960-11	ELECT	1µF 20% 50V
CAPACITOR				C030	1-165-176-11	CERAMIC CHIP	0.047µF 10% 16V
C001	1-164-315-11	CERAMIC CHIP	470pF 5% 50V	C031	1-164-230-11	CERAMIC CHIP	220pF 5% 50V
C002	1-164-230-11	CERAMIC CHIP	220pF 5% 50V	C032	1-126-964-11	ELECT	10µF 20% 50V
C003	1-107-826-11	CERAMIC CHIP	0.1µF 10% 16V	C033	1-125-837-91	CERAMIC CHIP	1µF 10% 6.3V
C004	1-126-947-11	ELECT	47µF 20% 25V	C034	1-162-964-11	CERAMIC CHIP	0.001µF 10% 50V
C005	1-164-739-11	CERAMIC CHIP	560pF 5% 50V	C035	1-162-964-11	CERAMIC CHIP	0.001µF 10% 50V
				C036	1-162-964-11	CERAMIC CHIP	0.001µF 10% 50V
				C037	1-164-230-11	CERAMIC CHIP	220pF 5% 50V
				C038	1-164-230-11	CERAMIC CHIP	220pF 5% 50V
				C039	1-162-964-11	CERAMIC CHIP	0.001µF 10% 50V
				C041	1-164-230-11	CERAMIC CHIP	220pF 5% 50V
				C043	1-164-230-11	CERAMIC CHIP	220pF 5% 50V
				C044	1-164-230-11	CERAMIC CHIP	220pF 5% 50V
				C045	1-126-964-11	ELECT	10µF 20% 50V
				C046	1-126-964-11	ELECT	10µF 20% 50V
				C047	1-126-941-11	ELECT	470µF 20% 25V
				C048	1-115-416-11	CERAMIC CHIP	0.001µF 5% 25V
				C049	1-126-964-11	ELECT	10µF 20% 50V
				C050	1-126-941-11	ELECT	470µF 20% 25V
				C051	1-126-947-11	ELECT	47µF 20% 25V
				C052	1-162-968-11	CERAMIC CHIP	0.0047µF 10% 50V





















REF. NO.	PART NO.	DESCRIPTION	VALUES	REF. NO.	PART NO.	DESCRIPTION	VALUES
C054	1-126-963-11	ELECT	4.7μF 20% 50V	C340	1-126-767-11	ELECT	1000μF 20% 16V
C055	1-126-933-11	ELECT	100μF 20% 16V	C341	1-126-947-11	ELECT	47μF 20% 25V
C060	1-164-230-11	CERAMIC CHIP	220pF 5% 50V	C343	1-107-826-11	CERAMIC CHIP	0.1μF 10% 16V
C062	1-125-837-91	CERAMIC CHIP	1μF 10% 6.3V	C344	1-162-970-11	CERAMIC CHIP	0.01μF 10% 25V
C065	1-125-891-11	CERAMIC CHIP	0.47μF 10% 10V	C345	1-113-619-11	CERAMIC CHIP	0.47μF 10V
C101	1-115-416-11	CERAMIC CHIP	0.001μF 5% 25V	C346	1-162-970-11	CERAMIC CHIP	0.01μF 10% 25V
C102	1-115-416-11	CERAMIC CHIP	0.001μF 5% 25V	C347	1-162-970-11	CERAMIC CHIP	0.01μF 10% 25V
C111	1-164-230-11	CERAMIC CHIP	220pF 5% 50V	C351	1-162-970-11	CERAMIC CHIP	0.01μF 10% 25V
C120	1-162-915-11	CERAMIC CHIP	10pF 0.50pF 50V	C352	1-126-947-11	ELECT	47μF 20% 25V
C121	1-162-915-11	CERAMIC CHIP	10pF 0.50pF 50V	C353	1-107-826-11	CERAMIC CHIP	0.1μF 10% 16V
C122	1-107-826-11	CERAMIC CHIP	0.1μF 10% 16V	C354	1-162-970-11	CERAMIC CHIP	0.01μF 10% 25V
C133	1-164-230-11	CERAMIC CHIP	220pF 5% 50V	C355	1-162-970-11	CERAMIC CHIP	0.01μF 10% 25V
C200	1-107-826-11	CERAMIC CHIP	0.1μF 10% 16V	C356	1-162-970-11	CERAMIC CHIP	0.01μF 10% 25V
C201	1-107-826-11	CERAMIC CHIP	0.1μF 10% 16V	C357	1-126-960-11	ELECT	1μF 20% 50V
C202	1-107-826-11	CERAMIC CHIP	0.1μF 10% 16V	C358	1-162-970-11	CERAMIC CHIP	0.01μF 10% 25V
C203	1-107-826-11	CERAMIC CHIP	0.1μF 10% 16V	C359	1-162-961-11	CERAMIC CHIP	330pF 10% 50V
C206	1-107-826-11	CERAMIC CHIP	0.1μF 10% 16V	C360	1-126-960-11	ELECT	1μF 20% 50V
C207	1-107-826-11	CERAMIC CHIP	0.1μF 10% 16V	C364	1-162-923-11	CERAMIC CHIP	47pF 5% 50V
C208	1-107-826-11	CERAMIC CHIP	0.1μF 10% 16V	C365	1-162-117-00	CERAMIC	100pF 10% 500V
C209	1-107-826-11	CERAMIC CHIP	0.1μF 10% 16V	C366	1-113-619-11	CERAMIC CHIP	0.47μF 10V
C210	1-126-963-11	ELECT	4.7μF 20% 50V	C367	1-113-619-11	CERAMIC CHIP	0.47μF 10V
C211	1-126-963-11	ELECT	4.7μF 20% 50V	C368	1-113-619-11	CERAMIC CHIP	0.47μF 10V
C212	1-126-963-11	ELECT	4.7μF 20% 50V	C371	1-115-156-11	CERAMIC CHIP	1μF 10V
C213	1-126-963-11	ELECT	4.7μF 20% 50V	C372	1-162-970-11	CERAMIC CHIP	0.01μF 10% 25V
C300	1-126-959-11	ELECT	0.47μF 20% 50V	C393	1-107-826-11	CERAMIC CHIP	0.1μF 10% 16V
C302	1-126-963-11	ELECT	4.7μF 20% 50V	C397	1-126-933-11	ELECT	100μF 20% 16V
C303	1-107-826-11	CERAMIC CHIP	0.1μF 10% 16V	C400	1-128-934-91	CERAMIC CHIP	0.33μF 20% 10V
C305	1-107-826-11	CERAMIC CHIP	0.1μF 10% 16V	C401	1-164-227-11	CERAMIC CHIP	0.022μF 10% 25V
C309	1-107-826-11	CERAMIC CHIP	0.1μF 10% 16V	C402	1-164-174-11	CERAMIC CHIP	0.0082μF 10% 25V
C311	1-126-947-11	ELECT	47μF 20% 25V	C403	1-162-967-11	CERAMIC CHIP	0.0033μF 10% 50V
C313	1-107-826-11	CERAMIC CHIP	0.1μF 10% 16V	C404	1-162-967-11	CERAMIC CHIP	0.0033μF 10% 50V
C319	1-107-826-11	CERAMIC CHIP	0.1μF 10% 16V	C405	1-164-677-11	CERAMIC CHIP	0.033μF 10% 16V
C320	1-126-959-11	ELECT	0.47μF 20% 50V	C406	1-164-677-11	CERAMIC CHIP	0.033μF 10% 16V
C321	1-126-947-11	ELECT	47μF 20% 25V	C407	1-162-965-11	CERAMIC CHIP	0.0015μF 10% 50V
C322	1-107-826-11	CERAMIC CHIP	0.1μF 10% 16V	C408	1-162-965-11	CERAMIC CHIP	0.0015μF 10% 50V
C325	1-162-923-11	CERAMIC CHIP	47pF 5% 50V	C409	1-127-715-91	CERAMIC CHIP	0.22μF 10% 16V
C326	1-164-373-11	CERAMIC CHIP	0.033μF 25V	C410	1-127-715-91	CERAMIC CHIP	0.22μF 10% 16V
C327	1-107-826-11	CERAMIC CHIP	0.1μF 10% 16V	C411	1-128-934-91	CERAMIC CHIP	0.33μF 20% 10V
C330	1-126-964-11	ELECT	10μF 20% 50V	C412	1-126-961-11	ELECT	2.2μF 20% 50V
C333	1-126-963-11	ELECT	4.7μF 20% 50V	C413	1-126-960-11	ELECT	1μF 20% 50V
C335	1-162-918-11	CERAMIC CHIP	18pF 5% 50V	C414	1-126-960-11	ELECT	1μF 20% 50V
C337	1-164-315-11	CERAMIC CHIP	470pF 5% 50V	C415	1-126-960-11	ELECT	1μF 20% 50V
C338	1-107-826-11	CERAMIC CHIP	0.1μF 10% 16V	C416	1-126-960-11	ELECT	1μF 20% 50V
C339	1-113-619-11	CERAMIC CHIP	0.47μF 10V	C417	1-115-416-11	CERAMIC CHIP	0.001μF 5% 25V

NOTE: The components identified by shading and  mark are critical for safety. Replace only with part number specified.

NOTE: Les composants identifiés par un trame et une  sont critiques pour la sécurité. Ne les remplacer que par une pièce portant le numéro spécifique.







REF. NO.	PART NO.	DESCRIPTION	VALUES	REF. NO.	PART NO.	DESCRIPTION	VALUES
C418	1-126-963-11	ELECT	4.7μF 20% 50V	C515	1-104-987-11	MYLAR	0.001μF 10% 100V
C420	1-126-960-11	ELECT	1μF 20% 50V	 C516	1-115-521-11	FILM (KV-32FV300/36FV300 ONLY)	0.82μF 5% 250V
C422	1-126-935-11	ELECT	470μF 20% 16V	 C516	1-115-522-11	FILM (KV-27FV300/29FV300 ONLY)	1μF 5% 250V
C426	1-126-964-11	ELECT	10μF 20% 50V	C517	1-107-649-11	ELECT	2.2μF 20% 250V
C427	1-126-964-11	ELECT	10μF 20% 50V	C518	1-106-387-00	MYLAR	0.068μF 10% 200V
C428	1-162-970-11	CERAMIC CHIP	0.01μF 10% 25V	C519	1-107-612-11	CERAMIC	100pF 5% 500V
C429	1-127-715-91	CERAMIC CHIP	0.22μF 10% 16V	C520	1-164-646-11	CERAMIC	2200pF 10% 500V
C430	1-162-968-11	CERAMIC CHIP	0.0047μF 10% 50V	C521	1-162-964-11	CERAMIC CHIP	0.001μF 10% 50V
C431	1-127-715-91	CERAMIC CHIP	0.22μF 10% 16V	C522	1-126-960-11	ELECT	1μF 20% 50V
C432	1-104-665-11	ELECT	100μF 20% 25V	C525	1-102-244-00	CERAMIC	220pF 10% 500V
C433	1-162-970-11	CERAMIC CHIP	0.01μF 10% 25V	C526	1-107-662-11	ELECT	22μF 20% 250V
C434	1-162-968-11	CERAMIC CHIP	0.0047μF 10% 50V	 C527	1-162-116-00	CERAMIC	680pF 10% 2KV
C435	1-162-968-11	CERAMIC CHIP	0.0047μF 10% 50V	C528	1-162-966-11	CERAMIC CHIP	0.0022μF 10% 50V
C442	1-127-715-91	CERAMIC CHIP (KV-32FV300/36FV300 ONLY)	0.22μF 10% 16V	C529	1-128-551-11	ELECT	22μF 20% 25V
C443	1-127-715-91	CERAMIC CHIP (KV-32FV300/36FV300 ONLY)	0.22μF 10% 16V	C530	1-130-475-00	MYLAR	0.0022μF 5% 50V
C452	1-107-826-11	CERAMIC CHIP	0.1μF 10% 16V	 C531	1-126-965-91	ELECT	22μF 20% 50V
C453	1-107-826-11	CERAMIC CHIP	0.1μF 10% 16V	 C532	1-126-965-91	ELECT	22μF 20% 50V
C501	1-102-110-00	CERAMIC	220pF 10% 50V	C534	1-126-967-11	ELECT	47μF 20% 50V
C502	1-126-959-11	ELECT	0.47μF 20% 50V	 C535	1-136-165-00	FILM	0.1μF 5% 50V
C503	1-164-315-11	CERAMIC CHIP	470pF 5% 50V	C537	1-126-941-11	ELECT	470μF 20% 25V
C504	1-102-228-00	CERAMIC	470pF 10% 500V	C539	1-126-941-11	ELECT	470μF 20% 25V
C505	1-102-228-00	CERAMIC	470pF 10% 500V	C540	1-107-995-11	ELECT	100μF 160V
C506	1-106-383-00	MYLAR	0.047μF 10% 200V	C541	1-128-560-11	ELECT	22μF 20% 100V
 C507	1-162-116-00	CERAMIC	680pF 10% 2KV	C544	1-129-718-00	FILM	0.022μF 5% 630V
C508	1-102-228-00	CERAMIC	470pF 10% 500V	C545	1-106-387-00	MYLAR	0.068μF 10% 200V
 C509	1-162-116-00	CERAMIC	680pF 10% 2KV	C546	1-104-987-11	MYLAR (KV-32FV300/36FV300 ONLY)	0.001μF 10% 100V
C510	1-137-150-11	MYLAR	0.01μF 10% 100V	C547	1-104-987-11	MYLAR (KV-32FV300/36FV300 ONLY)	0.001μF 10% 100V
 C511	1-117-652-11	FILM (KV-32FV300/36FV300 ONLY)	22000pF 3% 1.2KV	C550	1-102-002-00	CERAMIC (KV-32FV300/36FV300 ONLY)	680pF 10% 500V
 C511	1-117-717-11	FILM (KV-27FV300/29FV300 ONLY)	17000pF 3% 1.2KV	C550	1-164-735-11	CERAMIC (KV-27FV300/29FV300 ONLY)	0.0015μF 10% 500V
C512	1-129-709-91	FILM (KV-27FV300/29FV300 ONLY)	0.0039μF 5% 630V	C551	1-109-954-11	ELECT	0.47μF 20% 160V
C512	1-129-928-00	FILM (KV-32FV300/36FV300 ONLY)	0.0027μF 10% 630V	C552	1-102-244-00	CERAMIC	220pF 10% 500V
 C513	1-129-722-00	FILM (KV-27FV300/29FV300 ONLY)	0.047μF 5% 630V	 C553	1-107-846-11	FILM (KV-27FV300/29FV300 ONLY)	0.1μF 5% 250V
 C513	1-130-118-91	FILM (KV-32FV300/36FV300 ONLY)	0.051μF 5% 400V	 C553	1-117-667-11	FILM (KV-32FV300/36FV300 ONLY)	0.47μF 5% 250V
 C514	1-109-844-11	FILM (KV-27FV300/29FV300 ONLY)	0.68μF 5% 250V	 C554	1-117-629-11	FILM (KV-27FV300/29FV300 ONLY)	2700pF 3% 1.2KV
 C514	1-115-521-11	FILM (KV-32FV300/36FV300 ONLY)	0.82μF 5% 250V				

NOTE: The components identified by shading and  mark are critical for safety. Replace only with part number specified.

NOTE: Les composants identifiés par un trame et une  sont critiques pour la sécurité. Ne les remplacer que par une pièce portant le numéro spécifique.



REF. NO.	PART NO.	DESCRIPTION	VALUES	REF. NO.	PART NO.	DESCRIPTION	VALUES
 C554	1-117-635-11	FILM (KV-32FV300/36FV300 ONLY)	4700pF 3% 1.2KV	D008	8-719-404-50	DIODE MA111-TX	
C561	1-126-967-11	ELECT	47μF 20% 50V	D009	8-719-982-22	DIODE MTZJ-T-77-30D	
C563	1-104-666-11	ELECT	220μF 20% 25V	D010	8-719-921-44	DIODE MTZJ-T-77-5.1C	
C564	1-126-960-11	ELECT	1μF 20% 50V	D110	8-719-991-33	DIODE 1SS133T-77	
C565	1-126-969-11	ELECT	220μF 20% 50V	D111	8-719-109-93	DIODE MTZJ-T-77-6.2B	
C568	1-136-169-00	FILM	0.22μF 5% 50V	D112	8-719-109-93	DIODE MTZJ-T-77-6.2B	
C571	1-126-942-61	ELECT	1000μF 20% 25V	D113	8-719-921-44	DIODE MTZJ-T-77-5.1C	
C572	1-126-942-61	ELECT	1000μF 20% 25V	D200	8-719-929-15	DIODE MTZJ-T-77-9.1B	
 C590	1-126-964-11	ELECT	10μF 20% 50V	D201	8-719-929-15	DIODE MTZJ-T-77-9.1B	
C1501	1-107-846-11	FILM (KV-32FV300/36FV300 ONLY)	0.1μF 5% 250V	D209	8-719-929-15	DIODE MTZJ-T-77-9.1B	
C6001	1-126-940-11	ELECT	330μF 20% 25V	D210	8-719-929-15	DIODE MTZJ-T-77-9.1B	
C6002	1-126-947-11	ELECT	47μF 20% 25V	D211	8-719-929-15	DIODE MTZJ-T-77-9.1B	
C6003	1-125-837-91	CERAMIC CHIP	1μF 10% 6.3V	D212	8-719-929-15	DIODE MTZJ-T-77-9.1B	
C6005	1-126-768-11	ELECT	2200μF 20% 16V	D213	8-719-929-15	DIODE MTZJ-T-77-9.1B	
CONNECTOR				D217	8-719-929-15	DIODE MTZJ-T-77-9.1B	
* CN001	1-560-124-00	PLUG,CONNECTOR (2.5MM)	4P	D218	8-719-929-15	DIODE MTZJ-T-77-9.1B	
* CN002	1-564-507-11	PLUG,CONNECTOR	4P	D219	8-719-929-15	DIODE MTZJ-T-77-9.1B	
* CN003	1-564-509-11	PLUG,CONNECTOR	6P	D302	8-719-981-99	DIODE MTZJ-T-77-3.3	
* CN004	1-564-507-11	PLUG,CONNECTOR	4P	D303	8-719-929-15	DIODE MTZJ-T-77-9.1B	
* CN005	1-564-508-11	PLUG,CONNECTOR	5P	D304	8-719-921-44	DIODE MTZJ-T-77-5.1C	
* CN006	1-564-506-11	PLUG,CONNECTOR	3P	D305	8-719-929-15	DIODE MTZJ-T-77-9.1B	
* CN303	1-564-511-11	PLUG,CONNECTOR	8P	D306	8-719-929-15	DIODE MTZJ-T-77-9.1B	
CN306	1-573-298-21	CONNECTOR, BOARD TO BOARD	20P	D307	8-719-929-15	DIODE MTZJ-T-77-9.1B	
* CN401	1-564-508-11	PLUG,CONNECTOR (KV-32FV300/36FV300 ONLY)	5P	D308	8-719-929-15	DIODE MTZJ-T-77-9.1B	
* CN410	1-564-506-11	PLUG,CONNECTOR	3P	D309	8-719-929-15	DIODE MTZJ-T-77-9.1B	
* CN501	1-580-798-11	CONNECTOR PIN (DY)	6P	D310	8-719-929-15	DIODE MTZJ-T-77-9.1B	
* CN502	1-764-333-11	PLUG,CONNECTOR	10P	D311	8-719-929-15	DIODE MTZJ-T-77-9.1B	
* CN503	1-564-510-11	PLUG,CONNECTOR	7P	D312	8-719-929-15	DIODE MTZJ-T-77-9.1B	
* CN504	1-564-509-11	PLUG,CONNECTOR	6P	D313	8-719-929-15	DIODE MTZJ-T-77-9.1B	
* CN505	1-564-510-11	PLUG,CONNECTOR	7P	D320	8-719-991-33	DIODE 1SS133T-77	
CN600	1-695-915-11	TAB (CONTACT)		D410	8-719-404-50	DIODE MA111-TX	
* CN906	1-564-506-11	PLUG,CONNECTOR	3P	D412	8-719-404-50	DIODE MA111-TX	
* CN3300	1-691-616-21	CONNECTOR, BOARD TO BOARD	15P	D413	8-719-921-63	DIODE MTZJ-T-77-7.5B	
* CN3301	1-691-616-21	CONNECTOR, BOARD TO BOARD	15P	D415	8-719-991-33	DIODE 1SS133T-77	
DIODE				D501	8-719-109-89	DIODE MTZJ-T-77-5.6C	
D002	8-719-921-44	DIODE MTZJ-T-77-5.1C		D502	8-719-945-80	DIODE ERC06-15S	
D004	8-719-921-44	DIODE MTZJ-T-77-5.1C		 D503	8-719-945-80	DIODE ERC06-15S	
D005	8-719-110-17	DIODE MTZJ-T-77-10B		D504	8-719-312-10	DIODE RU4AM-T3	
D006	8-719-110-17	DIODE MTZJ-T-77-10B		D505	8-719-908-03	DIODE GP08DPKG23	
D007	8-719-404-50	DIODE MA111-TX		D506	8-719-908-03	DIODE GP08DPKG23	
				D507	8-719-991-33	DIODE 1SS133T-77	
				 D508	8-719-991-33	DIODE 1SS133T-77	
				D510	8-719-081-93	DIODE 1N4937/23	
				D511	8-719-970-87	DIODE ERA38-06TP1	

NOTE: The components identified by shading and \triangle mark are critical for safety. Replace only with part number specified.

NOTE: Les composants identifiés par un trame et une marque \triangle sont critiques pour la sécurité. Ne les remplacer que par une pièce portant le numéro spécifique.













REF. NO.	PART NO.	DESCRIPTION	VALUES	REF. NO.	PART NO.	DESCRIPTION	VALUES
D512	8-719-970-87	DIODE ERA38-06TP1		JACK			
D513	8-719-110-41	DIODE MTZJ-T-77-15B		J201	1-794-119-11	TERMINAL BLOCK, S	4P
\triangle D515	8-719-075-41	DIODE PR1004GT		J203	1-794-118-11	JACK BLOCK, PIN	3P
D516	8-719-991-33	DIODE 1SS133T-77		J204	1-794-118-11	JACK BLOCK, PIN	3P
D518	8-719-991-33	DIODE 1SS133T-77		J205	1-794-116-11	JACK BLOCK, PIN	2P
\triangle D519	8-719-302-43	DIODE EL1Z-V1		J206	1-794-117-11	JACK BLOCK, PIN	3P
\triangle D520	8-719-991-33	DIODE 1SS133T-77		J207	1-794-116-11	JACK BLOCK, PIN	2P
D521	8-719-921-63	DIODE MTZJ-T-77-7.5X		CHIP CONDUCTOR			
\triangle D522	8-719-991-33	DIODE 1SS133T-77		JR1	1-216-864-11	SHORT	
D523	8-719-109-69	DIODE MTZJ-T-77-3.6B		JR2	1-216-864-11	SHORT	
D524	8-719-109-97	DIODE MTZJ-T-77-6.8B		JR4	1-216-864-11	SHORT	
\triangle D530	8-719-979-85	DIODE RGP15GPKG23		JR5	1-216-864-11	SHORT	
D531	8-719-979-85	DIODE RGP15GPKG23		JR8	1-216-864-11	SHORT	
D534	8-719-302-43	DIODE RGP10GPKG23		JR9	1-216-864-11	SHORT	
D535	8-719-404-50	DIODE MA111-TX		JR10	1-216-864-11	SHORT	
D536	8-719-404-50	DIODE MA111-TX				(KV-32FV300/36FV300 ONLY)	
D561	8-719-075-33	DIODE 1N4003GA		JR12	1-216-864-11	SHORT	
\triangle D580	8-719-991-33	DIODE 1SS133T-77		JR13	1-216-864-11	SHORT	
D590	8-719-991-33	DIODE 1SS133T-77		JR14	1-216-864-11	SHORT	
FERRITE BEAD				JR15	1-216-864-11	SHORT	
FB501	1-410-397-21	FERRITE	1.1 μ H	JR202	1-216-864-11	SHORT	
FB502	1-410-397-21	FERRITE	1.1 μ H	JR301	1-216-864-11	SHORT	
FB503	1-410-397-21	FERRITE	1.1 μ H	JR302	1-216-864-11	SHORT	
IC				JR303	1-216-864-11	SHORT	
IC001	6-801-165-01	IC M306V5ME-109SP		JR304	1-216-864-11	SHORT	
IC002	6-701-929-01	IC BD4743G-TR		JR305	1-216-864-11	SHORT	
IC003	8-759-641-86	IC BR24C16F-E2		JR306	1-216-864-11	SHORT	
IC301	8-752-100-49	IC CXA2154AS		JR401	1-216-864-11	SHORT	
IC400	6-701-106-01	IC NJW1134GK1-TE2		JR402	1-216-864-11	SHORT	
IC402	8-759-689-71	IC NJM2188M-TE2		JR403	1-216-864-11	SHORT	
IC403	6-702-114-01	IC BU4051BCF-E2		COIL			
		(KV-32FV300/36FV300 ONLY)		L001	1-410-482-31	INDUCTOR	100 μ H
IC404	6-702-114-01	IC BU4051BCF-E2		L002	1-410-482-31	INDUCTOR	100 μ H
		(KV-32FV300/36FV300 ONLY)		L003	1-412-029-11	INDUCTOR	10 μ H
IC501	8-759-700-07	IC NJM2903M-TE2		L004	1-410-482-31	INDUCTOR	100 μ H
\triangle IC561	8-759-696-71	IC STV9379		L009	1-410-482-31	INDUCTOR	100 μ H
		(KV-32FV300/36FV300 ONLY)		L010	1-414-182-11	INDUCTOR	6.8 μ H
\triangle IC561	8-759-980-58	IC TDA8172		L300	1-410-482-31	INDUCTOR	100 μ H
		(KV-27FV300/29FV300 ONLY)		L301	1-410-482-31	INDUCTOR	100 μ H
IC6008	6-701-752-01	IC NJM2930F05		L302	1-412-029-11	INDUCTOR	10 μ H
				L303	1-410-478-11	INDUCTOR	47 μ H

NOTE: The components identified by shading and  mark are critical for safety. Replace only with part number specified.

NOTE: Les composants identifiés par un trame et une  sont critiques pour la sécurité. Ne les remplacer que par une pièce portant le numéro spécifique.





REF. NO.	PART NO.	DESCRIPTION	VALUES	REF. NO.	PART NO.	DESCRIPTION	VALUES
L304	1-410-470-11	INDUCTOR	10µH	Q407	8-729-422-27	TRANSISTOR 2SD601A-QRS-TX	
L501	1-406-677-11	INDUCTOR	10MH	Q501	8-729-140-50	TRANSISTOR 2SC3209LK-TP	
L502	1-412-552-11	INDUCTOR	2.2MH	 Q502	6-550-107-01	TRANSISTOR 2SD2645-YB	
L503	1-406-677-11	INDUCTOR	10MH	Q507	8-729-043-95	TRANSISTOR 2SC3840K	
L504	1-406-677-11	INDUCTOR	10MH	 Q511	8-729-120-28	TRANSISTOR 2SC2412K-T-146-QR	
 L505	1-406-976-11	INDUCTOR	68µH	 Q512	8-729-809-29	TRANSISTOR 2SC4159-E	
	(KV-32FV300/36FV300 ONLY)			 Q530	8-729-422-27	TRANSISTOR 2SD601A-QRS-TX	
 L505	1-406-978-11	INDUCTOR	150µH	 Q531	8-729-424-02	TRANSISTOR 2SB709A-QRS-TX	
	(KV-27FV300/29FV300 ONLY)			 Q532	8-729-200-17	TRANSISTOR 2SA10910-TPE2	
L511	1-409-955-11	INDUCTOR	8MH	Q561	8-729-422-27	TRANSISTOR 2SD601A-QRS-TX	
L517	1-412-552-11	INDUCTOR	2.2MH	Q562	8-729-120-28	TRANSISTOR 2SC2412K-T-146-QR	
TRANSISTOR				 Q590	8-729-422-27	TRANSISTOR 2SD601A-QRS-TX	
Q001	8-729-424-02	TRANSISTOR 2SB709A-QRS-TX		Q6000	8-729-422-27	TRANSISTOR 2SD601A-QRS-TX	
Q002	8-729-422-27	TRANSISTOR 2SD601A-QRS-TX		RESISTOR			
 Q003	8-729-422-27	TRANSISTOR 2SD601A-QRS-TX		R001	1-249-429-11	CARBON	10K 5% 1/4W
Q004	8-729-422-27	TRANSISTOR 2SD601A-QRS-TX		R002	1-249-409-11	CARBON	220 5% 1/4W
Q005	8-729-422-27	TRANSISTOR 2SD601A-QRS-TX		R003	1-216-817-11	RES-CHIP	470 5% 1/10W
Q010	8-729-424-02	TRANSISTOR 2SB709A-QRS-TX		R004	1-216-857-11	RES-CHIP	1M 5% 1/10W
Q110	8-729-424-02	TRANSISTOR 2SB709A-QRS-TX		R005	1-216-821-11	RES-CHIP	1K 5% 1/10W
Q300	8-729-424-02	TRANSISTOR 2SB709A-QRS-TX		R006	1-249-417-11	CARBON	1K 5% 1/4W
Q304	8-729-422-27	TRANSISTOR 2SD601A-QRS-TX		R007	1-216-833-11	RES-CHIP	10K 5% 1/10W
Q305	8-729-424-02	TRANSISTOR 2SB709A-QRS-TX		R009	1-216-864-11	SHORT	
Q306	8-729-422-27	TRANSISTOR 2SD601A-QRS-TX		R010	1-249-409-11	CARBON	220 5% 1/4W
Q307	8-729-424-02	TRANSISTOR 2SB709A-QRS-TX		R011	1-216-821-11	RES-CHIP	1K 5% 1/10W
Q308	8-729-424-02	TRANSISTOR 2SB709A-QRS-TX		R012	1-216-827-11	RES-CHIP	3.3K 5% 1/10W
Q309	8-729-424-02	TRANSISTOR 2SB709A-QRS-TX		R013	1-216-833-11	RES-CHIP	10K 5% 1/10W
Q314	8-729-422-27	TRANSISTOR 2SD601A-QRS-TX		R015	1-216-813-11	RES-CHIP	220 5% 1/10W
Q315	8-729-424-02	TRANSISTOR 2SB709A-QRS-TX		R016	1-216-813-11	RES-CHIP	220 5% 1/10W
Q316	8-729-424-02	TRANSISTOR 2SB709A-QRS-TX		R017	1-216-813-11	RES-CHIP	220 5% 1/10W
Q317	8-729-422-27	TRANSISTOR 2SD601A-QRS-TX		R018	1-216-813-11	RES-CHIP	220 5% 1/10W
Q319	8-729-422-27	TRANSISTOR 2SD601A-QRS-TX		R019	1-216-829-11	RES-CHIP	4.7K 5% 1/10W
Q325	8-729-422-27	TRANSISTOR 2SD601A-QRS-TX		R020	1-218-688-11	METAL CHIP	680 0.50% 1/16W
Q326	8-729-424-02	TRANSISTOR 2SB709A-QRS-TX		R021	1-216-829-11	RES-CHIP	4.7K 5% 1/10W
Q400	8-729-422-27	TRANSISTOR 2SD601A-QRS-TX		R022	1-218-688-11	METAL CHIP	680 0.50% 1/16W
Q401	8-729-422-27	TRANSISTOR 2SD601A-QRS-TX		R023	1-216-829-11	RES-CHIP	4.7K 5% 1/10W
Q402	8-729-422-27	TRANSISTOR 2SD601A-QRS-TX		R024	1-218-688-11	METAL CHIP	680 0.50% 1/16W
Q403	8-729-422-27	TRANSISTOR 2SD601A-QRS-TX		R025	1-216-813-11	RES-CHIP	220 5% 1/10W
Q404	8-729-422-27	TRANSISTOR 2SD601A-QRS-TX		R027	1-216-813-11	RES-CHIP	220 5% 1/10W
	(KV-32FV300/36FV300 ONLY)			R029	1-249-409-11	CARBON	220 5% 1/4W
Q405	8-729-422-27	TRANSISTOR 2SD601A-QRS-TX		R030	1-216-841-11	RES-CHIP	47K 5% 1/10W
	(KV-32FV300/36FV300 ONLY)			R031	1-216-809-11	RES-CHIP	100 5% 1/10W
Q406	8-729-422-27	TRANSISTOR 2SD601A-QRS-TX		R032	1-216-813-11	RES-CHIP	220 5% 1/10W
	(KV-32FV300/36FV300 ONLY)			R033	1-249-417-11	CARBON	1K 5% 1/4W

NOTE: The components identified by shading and  mark are critical for safety. Replace only with part number specified.

NOTE: Les composants identifiés par un trame et une  sont critiques pour la sécurité. Ne les remplacer que par une pièce portant le numéro spécifique.



REF. NO.	PART NO.	DESCRIPTION	VALUES			REF. NO.	PART NO.	DESCRIPTION	VALUES		
R034	1-216-813-11	RES-CHIP	220	5%	1/10W	R111	1-216-809-11	RES-CHIP	100	5%	1/10W
R035	1-216-813-11	RES-CHIP	220	5%	1/10W	R113	1-247-807-31	CARBON	100	5%	1/4W
R037	1-216-829-11	RES-CHIP	4.7K	5%	1/10W	R114	1-249-409-11	CARBON	220	5%	1/4W
R038	1-249-417-11	CARBON	1K	5%	1/4W	R117	1-216-837-11	RES-CHIP	22K	5%	1/10W
R039	1-216-829-11	RES-CHIP	4.7K	5%	1/10W	R118	1-216-837-11	RES-CHIP	22K	5%	1/10W
R048	1-216-829-11	RES-CHIP	4.7K	5%	1/10W	R120	1-249-413-11	CARBON	470	5%	1/4W
R050	1-216-833-11	RES-CHIP	10K	5%	1/10W	R123	1-249-421-11	CARBON	2.2K	5%	1/4W
R051	1-216-857-11	RES-CHIP	1M	5%	1/10W			(KV-32FV300/36FV300 ONLY)			
R052	1-216-845-11	RES-CHIP	100K	5%	1/10W	R124	1-216-813-11	RES-CHIP	220	5%	1/10W
R053	1-216-821-11	RES-CHIP	1K	5%	1/10W			(KV-32FV300/36FV300 ONLY)			
R054	1-249-417-11	CARBON	1K	5%	1/4W	R125	1-249-421-11	CARBON	2.2K	5%	1/4W
R055	1-216-841-11	RES-CHIP	47K	5%	1/10W			(KV-32FV300/36FV300 ONLY)			
R056	1-216-813-11	RES-CHIP	220	5%	1/10W	R126	1-216-813-11	RES-CHIP	220	5%	1/10W
R057	1-216-845-11	RES-CHIP	100K	5%	1/10W			(KV-32FV300/36FV300 ONLY)			
R058	1-216-845-11	RES-CHIP	100K	5%	1/10W	R127	1-249-421-11	CARBON	2.2K	5%	1/4W
R060	1-249-409-11	CARBON	220	5%	1/4W			(KV-32FV300/36FV300 ONLY)			
R061	1-249-437-11	CARBON	47K	5%	1/4W	R128	1-216-813-11	RES-CHIP	220	5%	1/10W
 R063	1-216-829-11	RES-CHIP	4.7K	5%	1/10W			(KV-32FV300/36FV300 ONLY)			
R064	1-216-813-11	RES-CHIP	220	5%	1/10W	R129	1-249-409-11	CARBON	220	5%	1/4W
R065	1-216-841-11	RES-CHIP	47K	5%	1/10W	R130	1-216-829-11	RES-CHIP	4.7K	5%	1/10W
R066	1-249-429-11	CARBON	10K	5%	1/4W	R131	1-216-813-11	RES-CHIP	220	5%	1/10W
R068	1-216-833-11	RES-CHIP	10K	5%	1/10W	R132	1-216-829-11	RES-CHIP	4.7K	5%	1/10W
R070	1-216-813-11	RES-CHIP	220	5%	1/10W	R133	1-216-841-11	RES-CHIP	47K	5%	1/10W
R071	1-216-841-11	RES-CHIP	47K	5%	1/10W	R134	1-216-813-11	RES-CHIP	220	5%	1/10W
R073	1-249-425-11	CARBON	4.7K	5%	1/4W	R135	1-216-813-11	RES-CHIP	220	5%	1/10W
R074	1-249-417-11	CARBON	1K	5%	1/4W	R136	1-249-425-11	CARBON	4.7K	5%	1/4W
R075	1-216-813-11	RES-CHIP	220	5%	1/10W	R137	1-216-829-11	RES-CHIP	4.7K	5%	1/10W
R076	1-216-841-11	RES-CHIP	47K	5%	1/10W	R139	1-216-813-11	RES-CHIP	220	5%	1/10W
R077	1-216-809-11	RES-CHIP	100	5%	1/10W	R140	1-249-409-11	CARBON	220	5%	1/4W
R078	1-216-841-11	RES-CHIP	47K	5%	1/10W	R145	1-249-401-11	CARBON	47	5%	1/4W
 R080	1-216-829-11	RES-CHIP	4.7K	5%	1/10W	R201	1-216-864-11	SHORT			
R085	1-215-924-00	METAL OXIDE	15K	5%	3W	R202	1-249-409-11	CARBON	220	5%	1/4W
R086	1-216-839-11	RES-CHIP	33K	5%	1/10W	R203	1-216-864-11	SHORT			
R087	1-216-837-11	RES-CHIP	22K	5%	1/10W	R206	1-249-409-11	CARBON	220	5%	1/4W
R089	1-216-829-11	RES-CHIP	4.7K	5%	1/10W	R207	1-216-845-11	RES-CHIP	100K	5%	1/10W
R098	1-216-821-11	RES-CHIP	1K	5%	1/10W	R208	1-249-409-11	CARBON	220	5%	1/4W
R099	1-216-809-11	RES-CHIP	100	5%	1/10W	R209	1-216-845-11	RES-CHIP	100K	5%	1/10W
R101	1-216-829-11	RES-CHIP	4.7K	5%	1/10W	R210	1-216-813-11	RES-CHIP	220	5%	1/10W
R102	1-216-829-11	RES-CHIP	4.7K	5%	1/10W	R217	1-216-845-11	RES-CHIP	100K	5%	1/10W
R103	1-249-425-11	CARBON	4.7K	5%	1/4W	R218	1-216-845-11	RES-CHIP	100K	5%	1/10W
R104	1-216-813-11	RES-CHIP	220	5%	1/10W	R219	1-216-813-11	RES-CHIP	220	5%	1/10W
R107	1-216-809-11	RES-CHIP	100	5%	1/10W	R220	1-216-813-11	RES-CHIP	220	5%	1/10W
R108	1-216-809-11	RES-CHIP	100	5%	1/10W	R222	1-216-845-11	RES-CHIP	100K	5%	1/10W
R110	1-247-807-31	CARBON	100	5%	1/4W	R223	1-216-813-11	RES-CHIP	220	5%	1/10W





























REF. NO.	PART NO.	DESCRIPTION	VALUES			REF. NO.	PART NO.	DESCRIPTION	VALUES		
R224	1-249-409-11	CARBON	220	5%	1/4W	R343	1-216-833-11	RES-CHIP	10K	5%	1/10W
R225	1-216-845-11	RES-CHIP	100K	5%	1/10W	R344	1-216-853-11	RES-CHIP	470K	5%	1/10W
R228	1-216-845-11	RES-CHIP	100K	5%	1/10W	R345	1-216-845-11	RES-CHIP	100K	5%	1/10W
R229	1-216-845-11	RES-CHIP	100K	5%	1/10W	R346	1-216-845-11	RES-CHIP	100K	5%	1/10W
R230	1-249-409-11	CARBON	220	5%	1/4W	R347	1-216-825-11	RES-CHIP	2.2K	5%	1/10W
R231	1-216-813-11	RES-CHIP	220	5%	1/10W	R348	1-216-825-11	RES-CHIP	2.2K	5%	1/10W
R232	1-216-853-11	RES-CHIP	470K	5%	1/10W	R349	1-216-864-11	SHORT			
R233	1-216-853-11	RES-CHIP	470K	5%	1/10W	R350	1-216-825-11	RES-CHIP	2.2K	5%	1/10W
R234	1-216-813-11	RES-CHIP	220	5%	1/10W	R351	1-216-864-11	SHORT			
R235	1-216-813-11	RES-CHIP	220	5%	1/10W	R352	1-216-864-11	SHORT			
R300	1-216-864-11	SHORT				R353	1-218-867-11	RES-CHIP	6.8K	5%	1/10W
R301	1-216-809-11	RES-CHIP	100	5%	1/10W	R354	1-249-425-11	CARBON	4.7K	5%	1/4W
R302	1-216-817-11	RES-CHIP	470	5%	1/10W	R359	1-216-833-11	RES-CHIP	10K	5%	1/10W
R303	1-249-414-11	CARBON	560	5%	1/4W	R368	1-216-864-11	SHORT			
R306	1-216-843-11	RES-CHIP	68K	5%	1/10W	R369	1-216-809-11	RES-CHIP	100	5%	1/10W
R307	1-216-843-11	RES-CHIP	68K	5%	1/10W	R370	1-216-809-11	RES-CHIP	100	5%	1/10W
R308	1-249-429-11	CARBON	10K	5%	1/4W	R372	1-216-864-11	SHORT			
R309	1-216-864-11	SHORT				R374	1-216-833-11	RES-CHIP	10K	5%	1/10W
R320	1-216-864-11	SHORT				R376	1-216-809-11	RES-CHIP	100	5%	1/10W
R322	1-216-829-11	RES-CHIP	4.7K	5%	1/10W	R378	1-216-809-11	RES-CHIP	100	5%	1/10W
R325	1-247-807-31	CARBON	100	5%	1/4W	R379	1-216-809-11	RES-CHIP	100	5%	1/10W
R328	1-216-833-11	RES-CHIP	10K	5%	1/10W	R380	1-216-809-11	RES-CHIP	100	5%	1/10W
R329	1-247-807-31	CARBON	100	5%	1/4W	R381	1-216-821-11	RES-CHIP	1K	5%	1/10W
R331	1-218-716-11	METAL CHIP	10K	0.50%	1/16W	R382	1-218-867-11	RES-CHIP	6.8K	5%	1/10W
R332	1-216-809-11	RES-CHIP	100	5%	1/10W	R383	1-249-421-11	CARBON	2.2K	5%	1/4W
R333	1-216-809-11	RES-CHIP	100	5%	1/10W	R384	1-216-840-11	RES-CHIP	39K	5%	1/10W
R334	1-216-821-11	RES-CHIP	1K	5%	1/10W	R385	1-216-813-11	RES-CHIP	220	5%	1/10W
R335	1-216-821-11	RES-CHIP	1K	5%	1/10W	R386	1-216-845-11	RES-CHIP	100K	5%	1/10W
R336	1-216-809-11	RES-CHIP	100	5%	1/10W	R387	1-216-864-11	SHORT			
R337	1-249-417-11	CARBON	1K	5%	1/4W	R388	1-216-821-11	RES-CHIP	1K	5%	1/10W
R338	1-216-864-11	SHORT				R389	1-216-864-11	SHORT			
R339	1-216-840-11 (KV-32FV300/36FV300 ONLY)	RES-CHIP	39K	5%	1/10W	R390	1-218-285-11	RES-CHIP	75	5%	1/10W
R339	1-216-851-11 (KV-27FV300/29FV300 ONLY)	RES-CHIP	330K	5%	1/10W	R391	1-218-285-11	RES-CHIP	75	5%	1/10W
R340	1-216-861-11 (KV-27FV300/29FV300 ONLY)	RES-CHIP	2.2M	5%	1/10W	R393	1-218-285-11	RES-CHIP	75	5%	1/10W
R340	1-216-863-11 (KV-32FV300/36FV300 ONLY)	RES-CHIP	3.3M	5%	1/10W	R394	1-218-285-11	RES-CHIP	75	5%	1/10W
R341	1-216-842-11 (KV-27FV300/29FV300 ONLY)	RES-CHIP	56K	5%	1/10W	R395	1-218-285-11	RES-CHIP	75	5%	1/10W
R341	1-216-851-11 (KV-32FV300/36FV300 ONLY)	RES-CHIP	330K	5%	1/10W	R396	1-216-853-11	RES-CHIP	470K	5%	1/10W
R342	1-216-839-11	RES-CHIP	33K	5%	1/10W	R397	1-249-417-11	CARBON	1K	5%	1/4W
						R398	1-216-841-11	RES-CHIP	47K	5%	1/10W
						R399	1-216-845-11	RES-CHIP	100K	5%	1/10W
						R400	1-216-829-11	RES-CHIP	4.7K	5%	1/10W
						R401	1-216-809-11	RES-CHIP	100	5%	1/10W
						R402	1-216-829-11 (KV-32FV300/36FV300 ONLY)	RES-CHIP	4.7K	5%	1/10W

NOTE: The components identified by shading and  mark are critical for safety. Replace only with part number specified.

A component identified by this  symbol indicates that it has been carefully factory-selected to satisfy regulations regarding X-ray radiation. Should replacement be required, replace only with the value originally used.

























REF. NO.	PART NO.	DESCRIPTION	VALUES			REF. NO.	PART NO.	DESCRIPTION	VALUES				
R403	1-216-809-11	RES-CHIP	100	5%	1/10W		R516	1-218-867-11	RES-CHIP	6.8K	5%	1/10W	
R404	1-216-829-11	RES-CHIP	4.7K	5%	1/10W			(KV-36FV300 ONLY)					
R405	1-216-825-11	RES-CHIP	2.2K	5%	1/10W		R517	1-249-417-11	CARBON	1K	5%	1/4W	
R406	1-216-825-11	RES-CHIP	2.2K	5%	1/10W		R518	1-216-833-11	RES-CHIP	10K	5%	1/10W	
R407	1-216-825-11	RES-CHIP	2.2K	5%	1/10W		R519	1-249-413-11	CARBON	470	5%	1/4W	
R408	1-216-825-11	RES-CHIP	2.2K	5%	1/10W		R520	1-215-907-11	METAL OXIDE	22	5%	3W	
R409	1-249-407-11	CARBON	150	5%	1/4W		R523	1-216-834-11	RES-CHIP	12K	5%	1/10W	
R411	1-216-817-11	RES-CHIP	470	5%	1/10W			(KV-32FV300/36FV300 ONLY)					
R412	1-216-821-11	RES-CHIP	1K	5%	1/10W		R523	1-216-837-11	RES-CHIP	22K	5%	1/10W	
R413	1-216-833-11	RES-CHIP	10K	5%	1/10W			(KV-27FV300/29FV300 ONLY)					
R416	1-216-829-11	RES-CHIP	4.7K	5%	1/10W		R524	1-249-429-11	CARBON	10K	5%	1/4W	
R420	1-216-824-11	RES-CHIP	1.8K	5%	1/10W								
R421	1-216-846-11	RES-CHIP	120K	5%	1/10W		R525	1-249-428-11	CARBON	8.2K	5%	1/4W	
R422	1-216-861-11	RES-CHIP	2.2M	5%	1/10W		R526	1-215-905-11	METAL OXIDE	10	5%	3W	
R423	1-216-839-11	RES-CHIP	33K	5%	1/10W			(KV-32FV300/36FV300 ONLY)					
R424	1-216-843-11	RES-CHIP	68K	5%	1/10W		R526	1-216-377-11	METAL OXIDE	4.7	5%	2W	
R425	1-216-842-11	RES-CHIP	56K	5%	1/10W			(KV-27FV300/29FV300 ONLY)					
R426	1-216-823-11	RES-CHIP	1.5K	5%	1/10W		R528	1-216-837-11	RES-CHIP	22K	5%	1/10W	
R452	1-249-409-11	CARBON	220	5%	1/4W		R529	1-216-837-11	RES-CHIP	22K	5%	1/10W	
R453	1-216-813-11	RES-CHIP	220	5%	1/10W			R530	1-216-834-11	RES-CHIP	12K	5%	1/10W
R501	1-216-815-11	RES-CHIP	330	5%	1/10W			R531	1-216-842-11	RES-CHIP	56K	5%	1/10W
R501	1-216-817-11	RES-CHIP	470	5%	1/10W		R532	1-216-810-11	RES-CHIP	120	5%	1/10W	
R501	1-216-817-11	RES-CHIP	470	5%	1/10W								
R502	1-216-829-11	RES-CHIP	4.7K	5%	1/10W		R533	1-215-879-11	METAL OXIDE	47K	5%	1W	
	R503	1-249-425-11	CARBON	4.7K	5%	1/4W		R536	1-260-288-11	CARBON	0.47	5%	1/2W
R504	1-215-885-00	METAL OXIDE	68	5%	2W		R537	1-260-288-11	CARBON	0.47	5%	1/2W	
R504	1-216-455-21	METAL OXIDE	560	5%	2W		R538	1-247-887-00	CARBON	220K	5%	1/4W	
R505	1-249-433-11	CARBON	22K	5%	1/4W		R540	1-216-857-11	RES-CHIP	1M	5%	1/10W	
R506	1-215-861-00	METAL OXIDE	47	5%	1W								
R507	1-249-401-11	CARBON	47	5%	1/4W		R541	1-215-894-11	METAL OXIDE	2.2K	5%	2W	
R508	1-249-425-11	CARBON	4.7K	5%	1/4W		R542	1-216-485-11	METAL OXIDE	5.6K	5%	3W	
	R509	1-260-328-11	CARBON	1K	5%	1/2W		R543	1-249-377-11	CARBON	0.47	5%	1/4W
	R510	1-215-883-11	METAL OXIDE	33	5%	2W		R545	1-249-387-11	CARBON	3.3	5%	1/4W
R512	1-215-910-00	METAL OXIDE	68	5%	3W		R546	1-215-453-00	METAL	22K	1%	1/4W	
R515	1-216-836-11	RES-CHIP	18K	5%	1/10W								
	R516	1-216-830-11	RES-CHIP	5.6K	5%	1/10W		R547	1-215-457-00	METAL	33K	1%	1/4W
		(KV-32FV300 ONLY)					R548	1-216-485-11	METAL OXIDE	5.6K	5%	3W	
	R516	1-216-832-11	RES-CHIP	8.2K	5%	1/10W		R549	1-215-437-00	METAL	4.7K	1%	1/4W
		(KV-27FV300/29FV300 ONLY)						R550	1-249-377-11	CARBON	0.47	5%	1/4W
							R551	1-215-873-00	METAL OXIDE	4.7K	5%	1W	
							R553	1-249-377-11	CARBON	0.47	5%	1/4W	
							R554	1-215-876-00	METAL OXIDE	15K	5%	1W	
								(KV-27FV300/29FV300 ONLY)					
							R554	1-215-894-11	METAL OXIDE	2.2K	5%	2W	
								(KV-32FV300 ONLY)					
							R555	1-249-441-11	CARBON	100K	5%	1/4W	
							R556	1-249-441-11	CARBON	100K	5%	1/4W	
							R557	1-249-441-11	CARBON	100K	5%	1/4W	

NOTE: The components identified by shading and  mark are critical for safety. Replace only with part number specified.

NOTE: Les composants identifiés par un trame et une  sont critiques pour la sécurité. Ne les remplacer que par une pièce portant le numéro spécifique.



REF. NO.	PART NO.	DESCRIPTION	VALUES			REF. NO.	PART NO.	DESCRIPTION	VALUES		
R559	1-216-805-11	RES-CHIP	47	5%	1/10W	R932	1-218-285-11	RES-CHIP	75	5%	1/10W
R561	1-249-429-11	CARBON	10K	5%	1/4W	R933	1-218-285-11	RES-CHIP	75	5%	1/10W
 R563	1-214-798-21	METAL	1.8	1%	1/2W	R934	1-218-285-11	RES-CHIP	75	5%	1/10W
 R564	1-247-895-91	CARBON	470K	5%	1/4W	R940	1-247-807-31	CARBON	100	5%	1/4W
R565	1-215-889-00	METAL OXIDE	330	5%	2W	R941	1-247-807-31	CARBON	100	5%	1/4W
R566	1-218-867-11	RES-CHIP	6.8K	5%	1/10W	R942	1-216-841-11	RES-CHIP	47K	5%	1/10W
 R567	1-249-385-11	CARBON	2.2	5%	1/4W	R947	1-216-864-11	SHORT			
R568	1-218-867-11	RES-CHIP	6.8K	5%	1/10W	R950	1-216-809-11	RES-CHIP	100	5%	1/10W
R569	1-249-429-11	CARBON	10K	5%	1/4W	R951	1-216-813-11	RES-CHIP	220	5%	1/10W
R570	1-216-845-11	RES-CHIP	100K	5%	1/10W	R6001	1-216-833-11	RES-CHIP	10K	5%	1/10W
R571	1-216-837-11	RES-CHIP	22K	5%	1/10W	R6002	1-216-833-11	RES-CHIP	10K	5%	1/10W
R572	1-216-837-11	RES-CHIP	22K	5%	1/10W	R6003	1-216-833-11	RES-CHIP	10K	5%	1/10W
R573	1-216-845-11	RES-CHIP	100K	5%	1/10W	R6004	1-216-821-11	RES-CHIP	1K	5%	1/10W
 R574	1-214-798-21	METAL	1.8	1%	1/2W	SWITCH					
R576	1-215-905-11	METAL OXIDE	10	5%	3W	S501	1-572-707-11	SWITCH LEVER			
	(KV-32FV300/36FV300 ONLY)										
R576	1-215-907-11	METAL OXIDE	22	5%	3W	S502	1-572-707-11	SWITCH LEVER			
	(KV-27FV300/29FV300 ONLY)										
R577	1-216-821-11	RES-CHIP	1K	5%	1/10W	TRANSFORMER					
R578	1-214-798-21	METAL	1.8	1%	1/2W	T501	1-433-836-11	TRANSFORMER, HORIZONTAL DRIVE			
R580	1-249-441-11	CARBON	100K	5%	1/4W	 T502	1-426-981-11	TRANSFORMER, FERRITE (PMT)			
R581	1-247-887-00	CARBON	220K	5%	1/4W	 T503	1-453-310-11	FBT ASSY, NX-4521//X4J4			
 R590	1-216-809-11	RES-CHIP	100	5%	1/10W		(KV-27FV300/29FV300 ONLY)				
 R591	1-249-417-11	CARBON	1K	5%	1/4W	 T503	1-453-338-21	FBT ASSY, NX-4600//X4C4			
 R592	1-216-363-00	METAL OXIDE	0.33	5%	2W		(KV-36FV300 ONLY)				
 R593	1-249-420-11	CARBON	1.8K	5%	1/4W	 T503	1-453-338-31	FBT ASSY, NX-4600//X4J4			
 R594	1-249-429-11	CARBON	10K	5%	1/4W		(KV-32FV300 ONLY)				
 R595	1-247-891-00	CARBON	330K	5%	1/4W	 T504	1-424-584-11	TRANSFORMER, DYNAMIC FOCUS			
 R596	1-249-441-11	CARBON	100K	5%	1/4W	 T505	1-431-693-11	TRANSFORMER, HORIZONTAL LINEAR			
 R597	1-216-864-11	SHORT					(KV-27FV300/29FV300 ONLY)				
 R598	1-218-867-11	RES-CHIP	6.8K	5%	1/10W	 T505	1-435-098-11	TRANSFORMER, HORIZONTAL LINEAR			
 R599	1-216-825-11	RES-CHIP	2.2K	5%	1/10W		(KV-32FV300/36FV300 ONLY)				
R900	1-216-821-11	RES-CHIP	1K	5%	1/10W	THERMISTOR					
R901	1-216-823-11	RES-CHIP	1.5K	5%	1/10W	TH501	1-800-193-00	THERMISTOR			
R902	1-216-809-11	RES-CHIP	100	5%	1/10W	TUNER					
R903	1-216-825-11	RES-CHIP	2.2K	5%	1/10W	 TU001	8-598-593-00	TUNER, FSS BTF-WA421			
R904	1-216-818-11	RES-CHIP	560	5%	1/10W	CRYSTAL					
R905	1-216-817-11	RES-CHIP	470	5%	1/10W	X001	1-781-931-21	VIBRATOR, CRYSTAL			
R906	1-249-417-11	CARBON	1K	5%	1/4W	X301	1-567-505-11	OSCILLATOR, CRYSTAL			
R907	1-216-833-11	RES-CHIP	10K	5%	1/10W						
R908	1-216-829-11	RES-CHIP	4.7K	5%	1/10W						
R909	1-249-417-11	CARBON	1K	5%	1/4W						
R910	1-216-833-11	RES-CHIP	10K	5%	1/10W						
R912	1-249-417-11	CARBON	1K	5%	1/4W						



REF. NO.	PART NO.	DESCRIPTION	VALUES	REF. NO.	PART NO.	DESCRIPTION	VALUES
BC							
*	A-1400-450-A	BC BOARD, MOUNTED					
	CAPACITOR						
C3355	1-162-964-11	CERAMIC CHIP	0.001μF 10% 50V	C3532	1-126-964-11	ELECT	10μF 20% 50V
C3356	1-126-964-11	ELECT	10μF 20% 50V	C3533	1-164-315-11	CERAMIC CHIP	470pF 5% 50V
C3357	1-113-619-11	CERAMIC CHIP	0.47μF 10V	C3534	1-126-960-11	ELECT	1μF 20% 50V
C3358	1-126-940-11	ELECT	330μF 20% 25V	C3535	1-162-917-11	CERAMIC CHIP	15pF 5% 50V
C3359	1-107-826-11	CERAMIC CHIP	0.1μF 10% 16V	C3536	1-126-960-11	ELECT	1μF 20% 50V
C3360	1-162-970-11	CERAMIC CHIP	0.01μF 10% 25V	C3537	1-126-964-11	ELECT	10μF 20% 50V
C3361	1-162-922-11	CERAMIC CHIP	39pF 5% 50V	C3538	1-162-917-11	CERAMIC CHIP	15pF 5% 50V
C3369	1-126-967-11	ELECT	47μF 20% 50V	C3539	1-162-917-11	CERAMIC CHIP	15pF 5% 50V
C3370	1-126-964-11	ELECT	10μF 20% 50V	C3541	1-162-921-11	CERAMIC CHIP	33pF 5% 50V
C3371	1-107-826-11	CERAMIC CHIP	0.1μF 10% 16V	C3542	1-126-964-11	ELECT	10μF 20% 50V
C3398	1-126-961-11	ELECT	2.2μF 20% 50V	C3543	1-135-834-91	CERAMIC CHIP	2.2μF 6.3V
C3504	1-162-920-11	CERAMIC CHIP	27pF 5% 50V	C3546	1-162-917-11	CERAMIC CHIP	15pF 5% 50V
C3505	1-162-920-11	CERAMIC CHIP	27pF 5% 50V	C3547	1-126-934-11	ELECT	220μF 20% 10V
C3506	1-164-360-11	CERAMIC CHIP	0.1μF 16V	C3548	1-107-826-11	CERAMIC CHIP	0.1μF 10% 16V
C3507	1-164-360-11	CERAMIC CHIP	0.1μF 16V	C3549	1-126-947-11	ELECT	47μF 20% 16V
C3509	1-164-360-11	CERAMIC CHIP	0.1μF 16V	C3550	1-162-974-11	CERAMIC CHIP	0.01μF 50V
C3510	1-164-392-11	CERAMIC CHIP	390pF 5% 50V	C3551	1-126-947-11	ELECT	47μF 20% 16V
C3511	1-164-360-11	CERAMIC CHIP	0.1μF 16V	C3552	1-162-974-11	CERAMIC CHIP	0.01μF 50V
C3512	1-164-360-11	CERAMIC CHIP	0.1μF 16V	C3553	1-162-974-11	CERAMIC CHIP	0.01μF 50V
C3513	1-216-864-11	SHORT		C3554	1-126-960-11	ELECT	1μF 20% 50V
C3514	1-162-974-11	CERAMIC CHIP	0.01μF 50V	C3555	1-126-934-11	ELECT	220μF 20% 10V
C3515	1-164-360-11	CERAMIC CHIP	0.1μF 16V	C3556	1-107-826-11	CERAMIC CHIP	0.1μF 10% 16V
C3516	1-164-360-11	CERAMIC CHIP	0.1μF 16V	C3557	1-162-974-11	CERAMIC CHIP	0.01μF 50V
C3517	1-126-924-11	ELECT	330μF 20% 6.3V	C3558	1-126-947-11	ELECT	47μF 20% 16V
C3518	1-164-360-11	CERAMIC CHIP	0.1μF 16V	C3559	1-162-974-11	CERAMIC CHIP	0.01μF 50V
C3519	1-164-360-11	CERAMIC CHIP	0.1μF 16V	C3560	1-126-947-11	ELECT	47μF 20% 16V
C3520	1-164-360-11	CERAMIC CHIP	0.1μF 16V	C3561	1-162-974-11	CERAMIC CHIP	0.01μF 50V
C3521	1-162-920-11	CERAMIC CHIP	27pF 5% 50V	C3562	1-162-974-11	CERAMIC CHIP	0.01μF 50V
C3522	1-126-947-11	ELECT	47μF 20% 16V	C3563	1-126-947-11	ELECT	47μF 20% 16V
C3523	1-164-360-11	CERAMIC CHIP	0.1μF 16V	C3564	1-126-947-11	ELECT	47μF 20% 16V
C3524	1-164-360-11	CERAMIC CHIP	0.1μF 16V	C3565	1-162-974-11	CERAMIC CHIP	0.01μF 50V
C3525	1-164-360-11	CERAMIC CHIP	0.1μF 16V	C3566	1-162-974-11	CERAMIC CHIP	0.01μF 50V
C3526	1-164-360-11	CERAMIC CHIP	0.1μF 16V	C3580	1-126-940-11	ELECT	330μF 20% 25V
C3527	1-164-360-11	CERAMIC CHIP	0.1μF 16V	C3581	1-107-826-11	CERAMIC CHIP	0.1μF 10% 16V
C3528	1-164-360-11	CERAMIC CHIP	0.1μF 16V	C3582	1-126-934-11	ELECT	220μF 20% 10V
C3529	1-164-360-11	CERAMIC CHIP	0.1μF 16V	C3583	1-126-934-11	ELECT	220μF 20% 10V
C3530	1-126-947-11	ELECT	47μF 20% 16V	C3585	1-107-826-11	CERAMIC CHIP	0.1μF 10% 16V
C3531	1-164-360-11	CERAMIC CHIP	0.1μF 16V	C3590	1-104-665-11	ELECT	100μF 20% 25V
				CONNECTOR			
				CN3500	1-573-301-21	CONNECTOR, BOARD TO BOARD 20P	



REF. NO.	PART NO.	DESCRIPTION	VALUES	REF. NO.	PART NO.	DESCRIPTION	VALUES
DIODE				TRANSISTOR			
D3550	8-719-977-28	DIODE UDZSTE-1710B		Q3500	8-729-424-02	TRANSISTOR 2SB709A-QRS-TX	
FERRITE BEAD				Q3501	8-729-422-27	TRANSISTOR 2SD601A-QRS-TX	
FB3502	1-414-234-22	FERRITE	0μH	Q3502	8-729-424-02	TRANSISTOR 2SB709A-QRS-TX	
FB3503	1-414-234-22	FERRITE	0μH	Q3503	8-729-422-27	TRANSISTOR 2SD601A-QRS-TX	
FB3504	1-414-234-22	FERRITE	0μH	Q3504	8-729-424-02	TRANSISTOR 2SB709A-QRS-TX	
FB3505	1-414-234-22	FERRITE	0μH	Q3505	8-729-422-27	TRANSISTOR 2SD601A-QRS-TX	
FB3506	1-414-234-22	FERRITE	0μH	Q3506	8-729-422-27	TRANSISTOR 2SD601A-QRS-TX	
FB3507	1-414-234-22	FERRITE	0μH	Q3508	8-729-422-27	TRANSISTOR 2SD601A-QRS-TX	
FB3508	1-414-234-22	FERRITE	0μH	Q3509	8-729-424-02	TRANSISTOR 2SB709A-QRS-TX	
FB3509	1-414-234-22	FERRITE	0μH	Q3510	8-729-424-02	TRANSISTOR 2SB709A-QRS-TX	
FILTER				Q3511	8-729-422-27	TRANSISTOR 2SD601A-QRS-TX	
FL3500	1-239-848-21	FILTER, LOW PASS		Q3512	8-729-422-27	TRANSISTOR 2SD601A-QRS-TX	
FL3501	1-239-848-21	FILTER, LOW PASS		Q3513	8-729-422-27	TRANSISTOR 2SD601A-QRS-TX	
FL3502	1-239-848-21	FILTER, LOW PASS		Q3514	8-729-424-02	TRANSISTOR 2SB709A-QRS-TX	
FL3503	1-239-848-21	FILTER, LOW PASS		Q3515	8-729-422-27	TRANSISTOR 2SD601A-QRS-TX	
FL3504	1-233-736-21	FILTER, EMI		Q3516	8-729-422-27	TRANSISTOR 2SD601A-QRS-TX	
FL3505	1-233-736-21	FILTER, EMI		Q3517	8-729-422-27	TRANSISTOR 2SD601A-QRS-TX	
FL3506	1-233-736-21	FILTER, EMI		Q3590	8-729-926-14	TRANSISTOR 2SD1292	
IC				RESISTOR			
IC3501	6-700-960-01	IC UPD64083GF-3BA		R3301	1-216-805-11	RES-CHIP	47 5% 1/10W
IC3502	8-759-462-91	IC TA1226N		R3302	1-216-805-11	RES-CHIP	47 5% 1/10W
IC3503	8-759-583-47	IC UPC2933T-E1		R3303	1-216-833-11	RES-CHIP	10K 5% 1/10W
IC3504	6-700-394-01	IC BA25BC0FP-E2		R3364	1-216-845-11	RES-CHIP	100K 5% 1/10W
IC3505	8-759-394-35	IC BA12T		R3365	1-216-841-11	RES-CHIP	47K 5% 1/10W
CHIP CONDUCTOR				R3366	1-216-850-11	RES-CHIP	270K 5% 1/10W
JR3301	1-216-864-11	SHORT		R3369	1-216-843-11	RES-CHIP	68K 5% 1/10W
JR3302	1-216-864-11	SHORT		R3373	1-216-809-11	RES-CHIP	100 5% 1/10W
JR3501	1-216-864-11	SHORT		R3505	1-216-864-11	SHORT	
COIL				R3506	1-216-864-11	SHORT	
L3352	1-414-186-31	INDUCTOR	33μH	R3507	1-216-864-11	SHORT	
L3500	1-414-265-21	INDUCTOR	4.7μH	R3508	1-216-864-11	SHORT	
L3501	1-412-058-11	INDUCTOR	10μH	R3509	1-216-821-11	RES-CHIP	1K 5% 1/10W
L3502	1-412-058-11	INDUCTOR	10μH	R3510	1-216-817-11	RES-CHIP	470 5% 1/10W
L3503	1-412-058-11	INDUCTOR	10μH	R3511	1-216-817-11	RES-CHIP	470 5% 1/10W
L3504	1-412-058-11	INDUCTOR	10μH	R3514	1-216-809-11	RES-CHIP	100 5% 1/10W
L3505	1-412-058-11	INDUCTOR	10μH	R3515	1-216-824-11	RES-CHIP	1.8K 5% 1/10W
				R3516	1-216-824-11	RES-CHIP	1.8K 5% 1/10W
				R3517	1-216-809-11	RES-CHIP	100 5% 1/10W
				R3518	1-216-809-11	RES-CHIP	100 5% 1/10W
				R3519	1-216-864-11	SHORT	
				R3520	1-218-708-11	METAL CHIP	4.7K 0.50% 1/16W



REF. NO.	PART NO.	DESCRIPTION	VALUES	REF. NO.	PART NO.	DESCRIPTION	VALUES
R3521	1-216-817-11	RES-CHIP	470 5% 1/10W	R3570	1-216-839-11	RES-CHIP	33K 5% 1/10W
R3522	1-216-817-11	RES-CHIP	470 5% 1/10W	R3571	1-216-834-11	RES-CHIP	12K 5% 1/10W
R3523	1-216-821-11	RES-CHIP	1K 5% 1/10W	R3572	1-216-821-11	RES-CHIP	1K 5% 1/10W
R3524	1-216-841-11	RES-CHIP	47K 5% 1/10W	R3573	1-216-805-11	RES-CHIP	47 5% 1/10W
R3525	1-216-825-11	RES-CHIP	2.2K 5% 1/10W	R3580	1-215-857-71	METAL OXIDE	10 5% 1W
R3526	1-216-849-11	RES-CHIP	220K 5% 1/10W	R3582	1-216-817-11	RES-CHIP	470 5% 1/10W
R3527	1-218-676-11	METAL CHIP	220 0.50% 1/16W	R3588	1-216-818-11	RES-CHIP	560 5% 1/10W
R3528	1-216-818-11	RES-CHIP	560 5% 1/10W	CRYSTAL			
R3529	1-216-818-11	RES-CHIP	560 5% 1/10W	X3500	1-767-606-11	VIBRATOR, CRYSTAL	
R3530	1-216-829-11	RES-CHIP	4.7K 5% 1/10W	HU			
R3531	1-216-821-11	RES-CHIP	1K 5% 1/10W	*	A-1400-451-A	HU BOARD, MOUNTED	
R3532	1-216-809-11	RES-CHIP	100 5% 1/10W	CAPACITOR			
R3533	1-216-821-11	RES-CHIP	1K 5% 1/10W	C2234	1-126-960-11	ELECT	1μF 20% 50V
R3535	1-216-809-11	RES-CHIP	100 5% 1/10W	C2235	1-126-960-11	ELECT	1μF 20% 50V
R3538	1-216-821-11	RES-CHIP	1K 5% 1/10W	C2240	1-126-959-11	ELECT	0.47μF 20% 50V
R3539	1-216-818-11	RES-CHIP	560 5% 1/10W	C2241	1-126-959-11	ELECT	0.47μF 20% 50V
R3540	1-216-821-11	RES-CHIP	1K 5% 1/10W	CONNECTOR			
R3541	1-216-830-11	RES-CHIP	5.6K 5% 1/10W	* CN1001	1-564-506-11	PLUG,CONNECTOR	3P
R3542	1-216-818-11	RES-CHIP	560 5% 1/10W	* CN1002	1-564-508-11	PLUG,CONNECTOR	5P
R3543	1-216-821-11	RES-CHIP	1K 5% 1/10W	* CN1003	1-564-507-11	PLUG,CONNECTOR	4P
R3544	1-216-821-11	RES-CHIP	1K 5% 1/10W	DIODE			
R3545	1-216-818-11	RES-CHIP	560 5% 1/10W	D301	8-719-929-15	DIODE MTZJ-T-77-9.1B	
R3547	1-216-829-11	RES-CHIP	4.7K 5% 1/10W	D2235	8-719-929-15	DIODE MTZJ-T-77-9.1B	
R3548	1-216-864-11	SHORT		D2236	8-719-929-15	DIODE MTZJ-T-77-9.1B	
R3549	1-216-825-11	RES-CHIP	2.2K 5% 1/10W	JACK			
R3550	1-216-820-11	RES-CHIP	820 5% 1/10W	J2231	1-770-053-12	TERMINAL BLOCK, S (LIGHT ANGLE)	
R3551	1-218-686-11	METAL CHIP	560 0.50% 1/16W	RESISTOR			
R3552	1-216-812-11	RES-CHIP	180 5% 1/10W	R1001	1-249-425-11	CARBON	4.7K 5% 1/4W
R3553	1-216-825-11	RES-CHIP	2.2K 5% 1/10W	R1002	1-249-420-11	CARBON	1.8K 5% 1/4W
R3554	1-216-820-11	RES-CHIP	820 5% 1/10W	R1003	1-249-417-11	CARBON	1K 5% 1/4W
R3555	1-216-834-11	RES-CHIP	12K 5% 1/10W	R2008	1-249-425-11	CARBON	4.7K 5% 1/4W
R3556	1-216-839-11	RES-CHIP	33K 5% 1/10W	R2009	1-249-420-11	CARBON	1.8K 5% 1/4W
R3557	1-216-821-11	RES-CHIP	1K 5% 1/10W	R2010	1-249-417-11	CARBON	1K 5% 1/4W
R3558	1-216-805-11	RES-CHIP	47 5% 1/10W	R2011	1-249-416-11	CARBON	820 5% 1/4W
R3559	1-216-864-11	SHORT		R2235	1-249-409-11	CARBON	220 5% 1/4W
R3560	1-216-821-11	RES-CHIP	1K 5% 1/10W	R2236	1-249-441-11	CARBON	100K 5% 1/4W
R3561	1-216-818-11	RES-CHIP	560 5% 1/10W	R2237	1-249-409-11	CARBON	220 5% 1/4W
R3563	1-216-864-11	SHORT					
R3564	1-216-864-11	SHORT					
R3565	1-216-829-11	RES-CHIP	4.7K 5% 1/10W				
R3566	1-216-825-11	RES-CHIP	2.2K 5% 1/10W				
R3567	1-216-819-11	RES-CHIP	680 5% 1/10W				
R3568	1-216-820-11	RES-CHIP	820 5% 1/10W				
R3569	1-216-825-11	RES-CHIP	2.2K 5% 1/10W				



REF. NO.	PART NO.	DESCRIPTION	VALUES			REF. NO.	PART NO.	DESCRIPTION	VALUES		
R2238	1-249-441-11	CARBON	100K	5%	1/4W	C3321	1-113-619-11	CERAMIC CHIP	0.47μF		10V
R2239	1-247-804-11	CARBON	75	5%	1/4W	C3322	1-164-373-11	CERAMIC CHIP	0.033μF		25V
R2240	1-247-804-11	CARBON	75	5%	1/4W	C3323	1-127-715-91	CERAMIC CHIP	0.22μF	10%	16V
R2241	1-247-804-11	CARBON	75	5%	1/4W	C3324	1-162-918-11	CERAMIC CHIP	18pF	5%	50V
						C3327	1-164-315-11	CERAMIC CHIP	470pF	5%	50V
		SWITCH				C3328	1-162-970-11	CERAMIC CHIP	0.01μF	10%	25V
S1007	1-762-816-11	SWITCH TACTILE				C3329	1-164-315-11	CERAMIC CHIP	470pF	5%	50V
S1008	1-762-816-11	SWITCH TACTILE				C3330	1-162-970-11	CERAMIC CHIP	0.01μF	10%	25V
S2001	1-692-431-21	SWITCH TACTILE				C3331	1-162-970-11	CERAMIC CHIP	0.01μF	10%	25V
S2002	1-692-431-21	SWITCH TACTILE				C3332	1-162-970-11	CERAMIC CHIP	0.01μF	10%	25V
S2003	1-692-431-21	SWITCH TACTILE				C3334	1-162-970-11	CERAMIC CHIP	0.01μF	10%	25V
S2004	1-692-431-21	SWITCH TACTILE				C3335	1-164-360-11	CERAMIC CHIP	0.1μF		16V
S2005	1-692-431-21	SWITCH TACTILE				C3336	1-162-970-11	CERAMIC CHIP	0.01μF	10%	25V
						C3337	1-164-360-11	CERAMIC CHIP	0.1μF		16V
						C3338	1-164-360-11	CERAMIC CHIP	0.1μF		16V
						C3339	1-126-965-91	ELECT	22μF	20%	50V
						C3340	1-126-947-11	ELECT	47μF	20%	16V
						C3341	1-162-970-11	CERAMIC CHIP	0.01μF	10%	25V
						C3390	1-104-665-11	ELECT	100μF	20%	25V
						C3391	1-104-665-11	ELECT	100μF	20%	25V
								CONNECTOR			
						* CN3302	1-691-632-21	CONNECTOR, BOARD TO BOARD 15P			
						* CN3303	1-691-632-21	CONNECTOR, BOARD TO BOARD 15P			
						CN6600	1-695-915-11	TAB (CONTACT)			
								DIODE			
						D103	8-719-404-50	DIODE MA111-TX			
						D104	8-719-404-50	DIODE MA111-TX			
						D3301	8-719-404-50	DIODE MA111-TX			
						D3304	8-719-109-72	DIODE MTZJ-T-77-3.9B			
								IC			
						IC3301	6-701-754-01	IC M65665ASP			
						IC3390	8-759-701-59	IC NJM78M09FA			
								CHIP CONDUCTOR			
						JR001	1-216-864-11	SHORT			
						JR002	1-216-864-11	SHORT			
								COIL			
						L150	1-414-857-11	INDUCTOR	100μH		
						L3300	1-412-058-11	INDUCTOR	10μH		
						L3301	1-410-682-31	INDUCTOR	470μH		
						L3302	1-412-058-11	INDUCTOR	10μH		

P

*

A-1400-456-A P (VAR) BOARD, MOUNTED

4-382-854-11 SCREW (M3X10), P, SW (+)

CAPACITOR

C100 1-126-968-11 ELECT 100μF 20% 50V
 C102 1-126-947-11 ELECT 47μF 20% 25V
 C103 1-126-964-11 ELECT 10μF 20% 50V
 C104 1-126-967-11 ELECT 47μF 20% 50V
 C106 1-162-968-11 CERAMIC CHIP 0.0047μF 10% 50V

C107 1-126-960-11 ELECT 1μF 20% 50V
 C109 1-164-230-11 CERAMIC CHIP 220pF 5% 50V
 C110 1-165-176-11 CERAMIC CHIP 0.047μF 10% 16V
 C111 1-126-960-11 ELECT 1μF 20% 50V
 C3300 1-115-156-11 CERAMIC CHIP 1μF 10V

C3301 1-115-156-11 CERAMIC CHIP 1μF 10V
 C3302 1-115-156-11 CERAMIC CHIP 1μF 10V
 C3303 1-126-947-11 ELECT 47μF 20% 16V
 C3304 1-164-315-11 CERAMIC CHIP 470pF 5% 50V
 C3305 1-164-360-11 CERAMIC CHIP 0.1μF 16V

C3308 1-126-947-11 ELECT 47μF 20% 16V
 C3312 1-164-315-11 CERAMIC CHIP 470pF 5% 50V
 C3313 1-162-927-11 CERAMIC CHIP 100pF 5% 50V
 C3316 1-126-947-11 ELECT 47μF 20% 16V
 C3317 1-162-970-11 CERAMIC CHIP 0.01μF 10% 25V

C3318 1-162-970-11 CERAMIC CHIP 0.01μF 10% 25V
 C3319 1-126-947-11 ELECT 47μF 20% 16V
 C3320 1-162-970-11 CERAMIC CHIP 0.01μF 10% 25V



REF. NO.	PART NO.	DESCRIPTION	VALUES			REF. NO.	PART NO.	DESCRIPTION	VALUES		
L3303	1-412-058-11	INDUCTOR	10μH			R3311	1-216-819-11	RES-CHIP	680	5%	1/10W
L3390	1-412-525-31	INDUCTOR	10μH			R3312	1-216-864-11	SHORT			
		TRANSISTOR				R3313	1-216-864-11	SHORT			
Q151	8-729-424-02	TRANSISTOR 2SB709A-QRS-TX				R3314	1-216-864-11	SHORT			
Q152	8-729-422-27	TRANSISTOR 2SD601A-QRS-TX				R3318	1-216-833-11	RES-CHIP	10K	5%	1/10W
Q3300	8-729-422-27	TRANSISTOR 2SD601A-QRS-TX				R3319	1-216-833-11	RES-CHIP	10K	5%	1/10W
Q3301	8-729-422-27	TRANSISTOR 2SD601A-QRS-TX				R3320	1-216-829-11	RES-CHIP	4.7K	5%	1/10W
Q3302	8-729-422-27	TRANSISTOR 2SD601A-QRS-TX				R3321	1-216-864-11	SHORT			
						R3322	1-249-414-11	CARBON	560	5%	1/4W
Q3304	8-729-926-14	TRANSISTOR 2SD1292				R3324	1-216-821-11	RES-CHIP	1K	5%	1/10W
Q3305	8-729-422-27	TRANSISTOR 2SD601A-QRS-TX				R3327	1-216-864-11	SHORT			
Q3307	8-729-424-02	TRANSISTOR 2SB709A-QRS-TX				R3328	1-216-821-11	RES-CHIP	1K	5%	1/10W
Q3308	8-729-424-02	TRANSISTOR 2SB709A-QRS-TX				R3329	1-216-864-11	SHORT			
Q3309	8-729-424-02	TRANSISTOR 2SB709A-QRS-TX				R3330	1-216-821-11	RES-CHIP	1K	5%	1/10W
						R3331	1-216-821-11	RES-CHIP	1K	5%	1/10W
Q3310	8-729-422-27	TRANSISTOR 2SD601A-QRS-TX									
Q3312	8-729-422-27	TRANSISTOR 2SD601A-QRS-TX				R3335	1-215-857-71	METAL OXIDE	10	5%	1W
		RESISTOR				R3336	1-216-817-11	RES-CHIP	470	5%	1/10W
R100	1-216-809-11	RES-CHIP	100	5%	1/10W	R3343	1-216-821-11	RES-CHIP	1K	5%	1/10W
R101	1-216-809-11	RES-CHIP	100	5%	1/10W	R3344	1-216-821-11	RES-CHIP	1K	5%	1/10W
R103	1-216-837-11	RES-CHIP	22K	5%	1/10W	R3346	1-216-821-11	RES-CHIP	1K	5%	1/10W
R104	1-216-839-11	RES-CHIP	33K	5%	1/10W	R3347	1-216-833-11	RES-CHIP	10K	5%	1/10W
R105	1-216-809-11	RES-CHIP	100	5%	1/10W						
						R3348	1-216-833-11	RES-CHIP	10K	5%	1/10W
R106	1-216-817-11	RES-CHIP	470	5%	1/10W	R3350	1-216-864-11	SHORT			
R107	1-216-817-11	RES-CHIP	470	5%	1/10W	R3351	1-216-813-11	RES-CHIP	220	5%	1/10W
R108	1-216-825-11	RES-CHIP	2.2K	5%	1/10W	R3354	1-216-863-11	RES-CHIP	3.3M	5%	1/10W
R112	1-216-825-11	RES-CHIP	2.2K	5%	1/10W	R3359	1-216-864-11	SHORT			
R113	1-216-845-11	RES-CHIP	100K	5%	1/10W						
						R3360	1-216-864-11	SHORT			
R114	1-216-857-11	RES-CHIP	1M	5%	1/10W	R3361	1-216-864-11	SHORT			
R115	1-216-833-11	RES-CHIP	10K	5%	1/10W	R3362	1-216-827-11	RES-CHIP	3.3K	5%	1/10W
R116	1-216-833-11	RES-CHIP	10K	5%	1/10W	R3363	1-216-839-11	RES-CHIP	33K	5%	1/10W
R117	1-216-829-11	RES-CHIP	4.7K	5%	1/10W	R3364	1-247-807-31	CARBON	100	5%	1/4W
R3300	1-216-841-11	RES-CHIP	47K	5%	1/10W						
						R3365	1-247-807-31	CARBON	100	5%	1/4W
R3301	1-216-821-11	RES-CHIP	1K	5%	1/10W	R3368	1-216-833-11	RES-CHIP	10K	5%	1/10W
R3302	1-216-841-11	RES-CHIP	47K	5%	1/10W	R3369	1-216-864-11	SHORT			
R3303	1-216-821-11	RES-CHIP	1K	5%	1/10W	R3372	1-216-864-11	SHORT			
R3304	1-216-821-11	RES-CHIP	1K	5%	1/10W	R3374	1-216-864-11	SHORT			
R3305	1-216-841-11	RES-CHIP	47K	5%	1/10W	R3390	1-216-395-00	METAL OXIDE	3.3	5%	3W
R3306	1-216-837-11	RES-CHIP	22K	5%	1/10W	TUNER					
R3307	1-216-821-11	RES-CHIP	1K	5%	1/10W	TU150	8-598-594-00	TUNER, FSS BTF-FA421			
R3308	1-216-837-11	RES-CHIP	22K	5%	1/10W						
R3309	1-216-817-11	RES-CHIP	470	5%	1/10W	CRYSTAL					
R3310	1-216-841-11	RES-CHIP	47K	5%	1/10W	X3301	1-781-377-41	VIBRATOR, CRYSTAL			



REF. NO.	PART NO.	DESCRIPTION	VALUES			REF. NO.	PART NO.	DESCRIPTION	VALUES		
HR											
*	A-1400-459-A	HR (COM) BOARD, MOUNTED									
	CAPACITOR										
C3001	1-104-665-11	ELECT	100μF	20%	25V	C415	1-162-970-11	CERAMIC CHIP	0.01μF	10%	25V
	CONNECTOR					C416	1-126-947-11	ELECT	47μF	20%	25V
CN3001	1-564-521-11	PLUG,CONNECTOR	6P			C417	1-126-963-11	ELECT	4.7μF	20%	50V
	DIODE					C418	1-162-916-11	CERAMIC CHIP	12pF	5%	50V
D3002	8-719-057-09	DIODE LNJ801LPDJA				C419	1-162-915-11	CERAMIC CHIP	10pF	0.50pF	50V
	IC					C420	1-162-970-11	CERAMIC CHIP	0.01μF	10%	25V
IC3001	8-742-211-20	HYB IC SBX3071-71				C421	1-162-970-11	CERAMIC CHIP	0.01μF	10%	25V
	RESISTOR					C422	1-126-947-11	ELECT	47μF	20%	25V
R3001	1-249-417-11	CARBON	1K	5%	1/4W	C423	1-162-970-11	CERAMIC CHIP	0.01μF	10%	25V
R3014	1-247-807-31	CARBON	100	5%	1/4W	C424	1-162-970-11	CERAMIC CHIP	0.01μF	10%	25V
	SWITCH					C425	1-126-947-11	ELECT	47μF	20%	25V
S3006	1-572-198-11	SWITCH KEYBOARD				C426	1-162-970-11	CERAMIC CHIP	0.01μF	10%	25V
T						C427	1-126-933-11	ELECT	100μF	20%	16V
*	A-1400-460-A	T BOARD, MOUNTED				CONNECTOR					
	(KV-32FV300/36FV300 ONLY)					* CN415	1-564-520-11	PLUG,CONNECTOR	5P		
	CAPACITOR					DIODE					
C401	1-162-923-11	CERAMIC CHIP	47pF	5%	50V	D401	8-719-109-89	DIODE MTZJ-T-77-5.6C			
C402	1-165-176-11	CERAMIC CHIP	0.047μF	10%	16V	D402	8-719-057-93	DIODE SVC203SPA-AL			
C403	1-126-963-11	ELECT	4.7μF	20%	50V	D403	8-719-057-93	DIODE SVC203SPA-AL			
C404	1-164-739-11	CERAMIC CHIP	560pF	5%	50V	D404	8-719-992-13	DIODE DAL5815			
C405	1-126-947-11	ELECT	47μF	20%	25V	D405	8-719-992-13	DIODE DAL5815			
C406	1-162-970-11	CERAMIC CHIP	0.01μF	10%	25V	D406	8-719-992-13	DIODE DAL5815			
C407	1-165-176-11	CERAMIC CHIP	0.047μF	10%	16V	D407	8-719-992-13	DIODE DAL5815			
C408	1-164-739-11	CERAMIC CHIP	560pF	5%	50V	D408	8-719-992-13	DIODE DAL5815			
C409	1-126-963-11	ELECT	4.7μF	20%	50V	D409	8-719-992-13	DIODE DAL5815			
C410	1-162-923-11	CERAMIC CHIP	47pF	5%	50V	D410	8-719-992-13	DIODE DAL5815			
C411	1-126-963-11	ELECT	4.7μF	20%	50V	D411	8-719-992-13	DIODE DAL5815			
C412	1-162-966-11	CERAMIC CHIP	0.0022μF	10%	50V	IC					
C413	1-162-966-11	CERAMIC CHIP	0.0022μF	10%	50V	IC401	8-759-939-73	IC BA3308			
C414	1-126-947-11	ELECT	47μF	20%	25V	COIL					
						L401	1-411-987-11	COIL (OSC)			
						L402	1-411-988-11	COIL (OSC)			
						L403	1-410-482-31	INDUCTOR	100μH		
						TRANSISTOR					
						Q401	8-729-266-83	TRANSISTOR 2SC2668-YTP			
						Q402	8-729-266-83	TRANSISTOR 2SC2668-YTP			
						Q403	8-729-423-33	TRANSISTOR 2SC3311A-QRSTA			
						Q404	8-729-424-02	TRANSISTOR 2SB709A-QRS-TX			
						Q405	8-729-424-02	TRANSISTOR 2SB709A-QRS-TX			





REF. NO.	PART NO.	DESCRIPTION	VALUES			REF. NO.	PART NO.	DESCRIPTION	VALUES		
Q406	8-729-931-14	TRANSISTOR 2SD1858-Q-TV2				R436	1-216-797-11	RES-CHIP	10	5%	1/10W
Q407	8-729-931-14	TRANSISTOR 2SD1858-Q-TV2				R437	1-216-797-11	RES-CHIP	10	5%	1/10W
Q408	8-729-931-14	TRANSISTOR 2SD1858-Q-TV2				R438	1-216-797-11	RES-CHIP	10	5%	1/10W
Q409	8-729-931-14	TRANSISTOR 2SD1858-Q-TV2				R439	1-216-826-11	RES-CHIP	2.7K	5%	1/10W
Q410	8-729-424-02	TRANSISTOR 2SB709A-QRS-TX				R440	1-216-864-11	SHORT			
Q411	8-729-424-02	TRANSISTOR 2SB709A-QRS-TX				R441	1-216-864-11	SHORT			
						R460	1-216-826-11	RES-CHIP	2.7K	5%	1/10W
RESISTOR											
R401	1-216-841-11	RES-CHIP	47K	5%	1/10W	C					
R402	1-216-841-11	RES-CHIP	47K	5%	1/10W	*					
R403	1-216-841-11	RES-CHIP	47K	5%	1/10W	A-1400-455-A C (COM) BOARD, MOUNTED (KV-27FV300/29FV300/32FV300 ONLY)					
R404	1-216-823-11	RES-CHIP	1.5K	5%	1/10W	*					
R405	1-216-809-11	RES-CHIP	100	5%	1/10W	A-1400-580-A C (VAR) BOARD, MOUNTED (KV-36FV300 ONLY)					
R406	1-216-823-11	RES-CHIP	1.5K	5%	1/10W	4-382-854-11 SCREW (M3X10), P, SW (+)					
R407	1-216-863-11	RES-CHIP	3.3M	5%	1/10W	CAPACITOR					
R408	1-216-841-11	RES-CHIP	47K	5%	1/10W	C701	1-126-947-11	ELECT	47µF	20%	25V
R409	1-216-823-11	RES-CHIP	1.5K	5%	1/10W	C702	1-136-165-00	FILM	0.1µF	5%	50V
R410	1-216-823-11	RES-CHIP	1.5K	5%	1/10W	C703	1-126-947-11	ELECT	47µF	20%	25V
R411	1-216-809-11	RES-CHIP	100	5%	1/10W	C704	1-107-652-11	ELECT	10µF	20%	250V
R412	1-218-713-11	METAL CHIP	7.5K	0.50%	1/16W	C705	1-107-652-11	ELECT	10µF	20%	250V
R413	1-216-829-11	RES-CHIP	4.7K	5%	1/10W	C706	1-137-528-11	MYLAR	0.1µF	10%	250V
R414	1-216-833-11	RES-CHIP	10K	5%	1/10W	C707	1-162-114-00	CERAMIC	0.0047µF		2KV
R415	1-249-411-11	CARBON	330	5%	1/4W	C708	1-136-165-00	FILM	0.1µF	5%	50V
R416	1-216-837-11	RES-CHIP	22K	5%	1/10W	C709	1-126-964-11	ELECT	10µF	20%	50V
R417	1-216-837-11	RES-CHIP	22K	5%	1/10W	C710	1-126-964-11	ELECT	10µF	20%	50V
R418	1-216-829-11	RES-CHIP	4.7K	5%	1/10W	C711	1-102-074-00	CERAMIC	0.001µF	10%	50V
R419	1-216-833-11	RES-CHIP	10K	5%	1/10W	CONNECTOR					
R420	1-216-852-11	RES-CHIP	390K	5%	1/10W	* CN701	1-564-506-11	PLUG,CONNECTOR			3P
R421	1-216-809-11	RES-CHIP	100	5%	1/10W	CN702	1-695-915-11	TAB (CONTACT)			
R422	1-216-809-11	RES-CHIP	100	5%	1/10W	CN704	1-785-879-11	CONNECTOR, ONE TOUCH			
R423	1-216-852-11	RES-CHIP	390K	5%	1/10W	* CN705	1-564-511-11	PLUG,CONNECTOR			8P
R424	1-216-823-11	RES-CHIP	1.5K	5%	1/10W	* CN706	1-564-510-11	PLUG,CONNECTOR			7P
R425	1-216-827-11	RES-CHIP	3.3K	5%	1/10W	* CN707	1-560-124-00	PLUG,CONNECTOR (2.5MM)			4P
R426	1-218-731-11	METAL CHIP	43K	0.50%	1/16W	(KV-36FV300 ONLY)					
R427	1-216-827-11	RES-CHIP	3.3K	5%	1/10W	DIODE					
R428	1-216-825-11	RES-CHIP	2.2K	5%	1/10W	D701	8-719-901-83	DIODE 1SS83TD			
R429	1-216-825-11	RES-CHIP	2.2K	5%	1/10W	D702	8-719-901-83	DIODE 1SS83TD			
R430	1-218-700-11	METAL CHIP	2.2K	0.50%	1/16W	D703	8-719-901-83	DIODE 1SS83TD			
R431	1-218-700-11	METAL CHIP	2.2K	0.50%	1/16W	D704	8-719-302-43	DIODE RGP10GPKG23			
R432	1-218-731-11	METAL CHIP	43K	0.50%	1/16W						
R433	1-216-826-11	RES-CHIP	2.7K	5%	1/10W						
R434	1-216-826-11	RES-CHIP	2.7K	5%	1/10W						
R435	1-216-797-11	RES-CHIP	10	5%	1/10W						

NOTE: The components identified by shading and  mark are critical for safety. Replace only with part number specified.

NOTE: Les composants identifiés par un trame et une marque  sont critiques pour la sécurité. Ne les remplacer que par une pièce portant le numéro spécifique.









REF. NO.	PART NO.	DESCRIPTION	VALUES			REF. NO.	PART NO.	DESCRIPTION	VALUES			
IC												
IC701	8-759-803-42	IC LA6500-FA										
IC702	8-759-562-43	IC TDA6108JF/N1B										
COIL						* A-1400-461-A V (VAR) BOARD, MOUNTED (KV-32FV300 ONLY)						
L701	1-408-613-31	INDUCTOR	68	μ H	* A-1400-565-A V (VAR) BOARD, MOUNTED (KV-27FV300/29FV300 ONLY)							
TRANSISTOR						* A-1400-581-A V (VAR) BOARD, MOUNTED (KV-36FV300 ONLY)						
Q700	8-729-423-33	TRANSISTOR 2SC3311A-QRSTA				4-382-854-11	SCREW (M3X10), P, SW (+)					
Q701	8-729-423-33	TRANSISTOR 2SC3311A-QRSTA				CAPACITOR						
RESISTOR						C802	1-126-964-11	ELECT	10	μ F	20%	50V
R700	1-249-433-11	CARBON	22K	5%	1/4W	C803	1-137-378-11	MYLAR	0.22	μ F	5%	50V
R701	1-249-429-11	CARBON	10K	5%	1/4W	C804	1-137-378-11	MYLAR	0.22	μ F	5%	50V
R702	1-249-409-11	CARBON	220	5%	1/4W	C805	1-129-763-61	FILM	0.033	μ F	5%	200V
R703	1-247-807-31	CARBON	100	5%	1/4W	C808	1-162-970-11	CERAMIC CHIP	0.01	μ F	10%	25V
R704	1-249-426-11	CARBON	5.6K	5%	1/4W	C809	1-128-934-91	CERAMIC CHIP	0.33	μ F	20%	10V
R705	1-249-429-11	CARBON	10K	5%	1/4W	C810	1-130-495-00	MYLAR	0.1	μ F	5%	50V
R706	1-249-381-11	CARBON	1	5%	1/4W	C811	1-129-765-00	FILM	0.047	μ F	5%	200V
 R707	1-249-383-11	CARBON	1.5	5%	1/4W	C812	1-162-970-11	CERAMIC CHIP	0.01	μ F	10%	25V
R708	1-247-807-31	CARBON	100	5%	1/4W	C813	1-126-933-11	ELECT	100	μ F	20%	16V
R709	1-247-807-31	CARBON	100	5%	1/4W	C821	1-162-970-11	CERAMIC CHIP	0.01	μ F	10%	25V
R710	1-247-807-31	CARBON	100	5%	1/4W	C823	1-130-967-00	FILM	0.0027	μ F	5%	50V
R711	1-260-328-11	CARBON	1K	5%	1/2W	C824	1-165-176-11	CERAMIC CHIP	0.047	μ F	10%	16V
R712	1-260-328-11	CARBON	1K	5%	1/2W	C826	1-162-927-11	CERAMIC CHIP	100	pF	5%	50V
R713	1-260-328-11	CARBON	1K	5%	1/2W	C862	1-126-964-11	ELECT	10	μ F	20%	50V
R714	1-260-087-11	CARBON	100	5%	1/2W	C901	1-107-667-11	ELECT	2.2	μ F	20%	160V
R715	1-260-132-11	CARBON	560K	5%	1/2W	C902	1-107-364-11	MYLAR	0.01	μ F	10%	200V
R716	1-260-123-11	CARBON	100K	5%	1/2W	C903	1-126-935-11	ELECT	470	μ F	20%	16V
R718	1-216-373-11	METAL OXIDE	2.2	5%	2W	C904	1-130-471-00	MYLAR	0.001	μ F	5%	50V
R719	1-215-888-00	METAL OXIDE	220	5%	2W	C905	1-107-364-11	MYLAR	0.01	μ F	10%	200V
R720	1-249-421-11	CARBON	2.2K	5%	1/4W	C906	1-130-471-00	MYLAR	0.001	μ F	5%	50V
R721	1-249-421-11	CARBON	2.2K	5%	1/4W	C907	1-107-963-11	ELECT	33	μ F	20%	160V
R722	1-247-807-31	CARBON	100	5%	1/4W	C908	1-126-935-11	ELECT	470	μ F	20%	16V
R723	1-247-807-31	CARBON	100	5%	1/4W	C909	1-104-999-11	MYLAR	0.1	μ F	10%	200V
R724	1-247-807-31	CARBON	100	5%	1/4W	C910	1-104-999-11	MYLAR	0.1	μ F	10%	200V
VARIABLE RESISTOR						C911	1-126-933-11	ELECT	100	μ F	20%	16V
RV701	1-241-656-11	RES,ADJ, METAL,FILM	110M	C912 1-126-933-11 ELECT 100 μ F 20% 16V								
						C913	1-102-074-00	CERAMIC	0.001	μ F	10%	50V
						C914	1-130-491-00	MYLAR	0.047	μ F	5%	50V
						C930	1-126-935-11	ELECT	470	μ F	20%	6.3V
						C931	1-126-935-11	ELECT	470	μ F	20%	6.3V

NOTE: The components identified by shading and  mark are critical for safety. Replace only with part number specified.

NOTE: Les composants identifiés par un trame et une  sont critiques pour la sécurité. Ne les remplacer que par une pièce portant le numéro spécifique.



REF. NO.	PART NO.	DESCRIPTION	VALUES	REF. NO.	PART NO.	DESCRIPTION	VALUES
CONNECTOR				Q907	8-729-120-28	TRANSISTOR 2SC2412K-T-146-QR	
* CN901	1-764-333-11	PLUG,CONNECTOR	10P	Q908	8-729-424-02	TRANSISTOR 2SB709A-QRS-TX	
* CN902	1-770-723-11	CONNECTOR, BOARD TO BOARD	8P	RESISTOR			
DIODE				R809	1-216-832-11	RES-CHIP	8.2K 5% 1/10W
D804	8-719-302-43	DIODE RGP10GPKG23		R811	1-249-393-11	CARBON	10 5% 1/4W
D805	8-719-991-33	DIODE 1SS133T-77		R814	1-215-862-11	METAL OXIDE	68 5% 1W
D806	8-719-991-33	DIODE 1SS133T-77		(KV-32FV300/36FV300 ONLY)			
D807	8-719-210-21	DIODE ERA82-004TP5		R815	1-215-862-11	METAL OXIDE	68 5% 1W
D808	8-719-991-33	DIODE 1SS133T-77		R817	1-218-734-11	METAL CHIP	56K 0.50% 1/16W
D813	8-719-991-33	DIODE 1SS133T-77		R818	1-216-809-11	RES-CHIP	100 5% 1/10W
D901	8-719-924-11	DIODE MTZJ-T-77-22		R819	1-216-841-11	RES-CHIP	47K 5% 1/10W
D902	8-719-924-11	DIODE MTZJ-T-77-22		R820	1-216-837-11	RES-CHIP	22K 5% 1/10W
D903	8-719-991-33	DIODE 1SS133T-77		R821	1-218-728-11	METAL CHIP	33K 0.50% 1/16W
D905	8-719-510-02	DIODE D1NS4-TR		R822	1-216-841-11	RES-CHIP	47K 5% 1/10W
D906	8-719-404-50	DIODE MA111-TX		R824	1-218-740-11	METAL CHIP	100K 0.50% 1/16W
D907	8-719-404-50	DIODE MA111-TX		R825	1-216-845-11	RES-CHIP	100K 5% 1/10W
D908	8-719-404-50	DIODE MA111-TX		R826	1-249-421-11	CARBON	2.2K 5% 1/4W
IC				R827	1-218-708-11	METAL CHIP	4.7K 0.50% 1/16W
IC801	6-701-598-01	IC UPC5023CS-184		R828	1-218-728-11	METAL CHIP	33K 0.50% 1/16W
CHIP CONDUCTOR				R829	1-216-797-11	RES-CHIP	10 5% 1/10W
JR802	1-216-864-11	SHORT		R833	1-216-830-11	RES-CHIP	5.6K 5% 1/10W
COIL				R834	1-216-830-11	RES-CHIP	5.6K 5% 1/10W
L801	1-406-989-21	INDUCTOR	10MH	R840	1-218-736-11	METAL CHIP	68K 0.50% 1/16W
L802	1-459-111-00	INDUCTOR	10MH	R841	1-216-826-11	RES-CHIP	2.7K 5% 1/10W
L803	1-412-529-81	INDUCTOR	22μH	R842	1-216-825-11	RES-CHIP	2.2K 5% 1/10W
L901	1-412-528-11	INDUCTOR	18μH	R855	1-216-835-11	RES-CHIP	15K 5% 1/10W
TRANSISTOR				R856	1-216-827-11	RES-CHIP	3.3K 5% 1/10W
Q805	6-550-106-01	TRANSISTOR KTB764		R857	1-218-728-11	METAL CHIP	33K 0.50% 1/16W
Q807	8-729-931-45	TRANSISTOR IRF614		R860	1-216-833-11	RES-CHIP	10K 5% 1/10W
Q808	6-550-106-01	TRANSISTOR KTB764		R864	1-218-668-11	METAL CHIP	100 0.50% 1/16W
Q812	8-729-026-39	TRANSISTOR 2SA933AS-QRT		R866	1-249-438-11	CARBON	56K 5% 1/4W
Q901	8-729-045-04	TRANSISTOR 2SC5511		R870	1-216-825-11	RES-CHIP	2.2K 5% 1/10W
Q902	8-729-045-05	TRANSISTOR 2SA2005		R876	1-216-821-11	RES-CHIP	1K 5% 1/10W
Q903	8-729-422-27	TRANSISTOR 2SD601A-QRS-TX		R890	1-218-867-11	RES-CHIP	6.8K 5% 1/10W
Q904	8-729-422-27	TRANSISTOR 2SD601A-QRS-TX		R893	1-216-839-11	RES-CHIP	33K 5% 1/10W
Q905	8-729-424-02	TRANSISTOR 2SB709A-QRS-TX		 R901	1-249-405-11	CARBON	100 5% 1/4W
Q906	8-729-120-28	TRANSISTOR 2SC2412K-T-146-QR		 R902	1-249-385-11	CARBON	2.2 5% 1/4W
				 R903	1-249-414-11	CARBON	560 5% 1/4W
				R904	1-249-432-11	CARBON	18K 5% 1/4W
				R905	1-249-421-11	CARBON	2.2K 5% 1/4W
				R906	1-249-432-11	CARBON	18K 5% 1/4W
				 R907	1-249-385-11	CARBON	2.2 5% 1/4W
				 R908	1-249-414-11	CARBON	560 5% 1/4W
				R909	1-260-316-51	CARBON	100 5% 1/2W

NOTE: The components identified by shading and  mark are critical for safety. Replace only with part number specified.

NOTE: Les composants identifiés par un trame et une marque  sont critiques pour la sécurité. Ne les remplacer que par une pièce portant le numéro spécifique.







REF. NO.	PART NO.	DESCRIPTION	VALUES			REF. NO.	PART NO.	DESCRIPTION	VALUES		
R910	1-215-915-11	METAL OXIDE	470	5%	3W	C617	1-123-024-21	ELECT	33µF		160V
R911	1-249-411-11	CARBON	330	5%	1/4W	C618	1-126-943-11	ELECT	2200µF	20%	25V
R912	1-249-407-11	CARBON	150	5%	1/4W	C620	1-162-970-11	CERAMIC CHIP	0.01µF	10%	25V
R913	1-249-399-11	CARBON	33	5%	1/4W	C621	1-117-894-11	ELECT	560µF	20%	250V
R914	1-249-416-11	CARBON	820	5%	1/4W	C624	1-107-636-11	ELECT	10µF	20%	160V
R915	1-249-425-11	CARBON	4.7K	5%	1/4W	C629	1-117-894-11	ELECT	560µF	20%	250V
R917	1-249-425-11	CARBON	4.7K	5%	1/4W	C632	1-126-947-11	ELECT	47µF	20%	25V
R918	1-249-401-11	CARBON	47	5%	1/4W	C633	1-136-479-11	FILM	0.001µF	2%	50V
R919	1-249-401-11	CARBON	47	5%	1/4W	C634	1-126-964-11	ELECT	10µF	20%	50V
R921	1-249-429-11	CARBON	10K	5%	1/4W	C635	1-126-963-11	ELECT	4.7µF	20%	50V
R922	1-249-397-11	CARBON	22	5%	1/4W	C637	1-136-165-00	FILM	0.1µF	5%	50V
R923	1-249-401-11	CARBON	47	5%	1/4W	C638	1-104-665-11	ELECT	100µF	20%	25V
R930	1-216-864-11	SHORT				C640	1-126-942-61	ELECT	1000µF	20%	25V
R931	1-249-421-11	CARBON	2.2K	5%	1/4W	C642	1-126-969-11	ELECT	220µF	20%	50V
R932	1-218-696-11	METAL CHIP	1.5K	0.50%	1/16W	C643	1-136-165-00	FILM	0.1µF	5%	50V
R933	1-216-864-11	SHORT				C645	1-162-964-11	CERAMIC CHIP	0.001µF	10%	50V
 R935	1-249-405-11	CARBON	100	5%	1/4W	C647	1-126-947-11	ELECT	47µF	20%	25V
R938	1-216-864-11	SHORT				C648	1-104-330-91	CERAMIC	470pF	10%	1KV
						C649	1-104-330-91	CERAMIC	470pF	10%	1KV
						C650	1-128-550-11	ELECT	2200µF	20%	50V
						C651	1-126-942-61	ELECT	1000µF	20%	25V
						C652	1-165-176-11	CERAMIC CHIP	0.047µF	10%	16V
						C653	1-126-960-11	ELECT	1µF	20%	50V
						C656	1-161-964-91	CERAMIC	0.0047µF		250V
						C658	1-161-964-91	CERAMIC	0.0047µF		250V
						C665	1-126-942-61	ELECT	1000µF	20%	25V
						C667	1-164-625-11	CERAMIC	680pF	10%	500V
						C668	1-164-625-11	CERAMIC	680pF	10%	500V
						C669	1-164-625-11	CERAMIC	680pF	10%	500V
						C670	1-164-625-11	CERAMIC	680pF	10%	500V
						C672	1-135-946-21	FILM	47000pF	3%	800V
						C690	1-126-971-11	ELECT	470µF	20%	50V
						C1401	1-137-652-91	CERAMIC CHIP	39000pF	10%	16V
						C1402	1-164-172-11	CERAMIC CHIP	0.0056µF	10%	25V
						C1403	1-107-826-11	CERAMIC CHIP	0.1µF	10%	16V
						C1404	1-162-927-11	CERAMIC CHIP	100pF	5%	50V
						C1405	1-126-947-11	ELECT	47µF	20%	25V
						C1406	1-162-970-11	CERAMIC CHIP	0.01µF	10%	25V
						C1407	1-126-965-91	ELECT	22µF	20%	50V
						C1408	1-126-768-11	ELECT	2200µF	20%	16V
						C1413	1-127-715-91	CERAMIC CHIP	0.22µF	10%	16V
						C1450	1-135-572-51	ELECT	1000µF	20%	50V
						C1451	1-113-619-11	CERAMIC CHIP	0.47µF		10V
						C1457	1-125-891-11	CERAMIC CHIP	0.47µF	10%	10V



- * **A-1400-452-A GK (VAR) BOARD, MOUNTED (KV-27FV300/29FV300(N)/32FV300 ONLY)**
- * **A-1400-583-A GK (VAR) BOARD, MOUNTED (KV-36FV300 ONLY)**
- * **A-1400-608-A GK (VAR) BOARD, MOUNTED (KV-29FV300(S) ONLY)**

- 1-533-223-11 HOLDER, FUSE
- * 4-374-846-11 COVER,CAPACITOR, CAP TYPE
- 4-382-854-11 SCREW (M3X10), P, SW (+)
- 4-382-854-11 SCREW (M3X10), P, SW (+)

CAPACITOR

C501	1-165-529-11	MYLAR	0.22µF	10%	275V
C600	1-117-703-11	CERAMIC	0.0047µF	20%	250V
					(KV-29FV300(S) ONLY)
 C601	1-165-529-11	MYLAR	0.22µF	10%	275V
 C603	1-165-529-11	MYLAR	0.22µF	10%	275V
C604	1-164-625-11	CERAMIC	680pF	10%	500V
 C607	1-119-912-51	CERAMIC	1000pF	20%	250V
 C608	1-119-912-51	CERAMIC	1000pF	20%	250V
C609	1-164-625-11	CERAMIC	680pF	10%	500V
C616	1-126-943-11	ELECT	2200µF	20%	25V

NOTE: The components identified by shading and \triangle mark are critical for safety. Replace only with part number specified.

NOTE: Les composants identifiés par un trame et une marque \triangle sont critiques pour la sécurité. Ne les remplacer que par une pièce portant le numéro spécifique.









REF. NO.	PART NO.	DESCRIPTION	VALUES	REF. NO.	PART NO.	DESCRIPTION	VALUES
C1458	1-162-970-11	CERAMIC CHIP	0.01 μ F 10% 25V				
C1461	1-113-619-11	CERAMIC CHIP	0.47 μ F 10V				
C1462	1-113-619-11	CERAMIC CHIP	0.47 μ F 10V				
C1463	1-126-968-11	ELECT	100 μ F 20% 50V				
CONNECTOR				FUSE			
*	CN503	1-573-963-11	PIN,CONNECTOR (PC BOARD) 3P	\triangle F601	1-576-193-11	FUSE	6.3A/125V
	CN600	1-580-843-11	PIN,CONNECTOR (POWER)		(KV-27FV300/29FV300(N)/32FV300/36FV300 ONLY)		
*	CN602	1-564-510-11	PLUG,CONNECTOR 7P	\triangle F601	1-532-506-51	FUSE	6.3A/250V
	CN603	1-695-915-11	TAB (CONTACT)		(KV-29FV300(S) ONLY)		
	CN604	1-695-915-11	TAB (CONTACT)				
			(KV-27FV300/29FV300(N)/32FV300/36FV300 ONLY)	FERRITE BEAD			
*	CN605	1-564-506-11	PLUG,CONNECTOR 3P	FB602	1-410-397-21	FERRITE	1.1 μ H
*	CN1401	1-564-507-11	PLUG,CONNECTOR 4P	FB604	1-410-397-21	FERRITE	1.1 μ H
	CN1402	1-564-505-11	PLUG,CONNECTOR 2P	FB605	1-410-397-21	FERRITE	1.1 μ H
*	CN1405	1-564-506-11	PLUG,CONNECTOR 3P	FB609	1-410-397-21	FERRITE	1.1 μ H
*	CN1601	1-564-509-11	PLUG,CONNECTOR 6P	FB610	1-410-397-21	FERRITE	1.1 μ H
DIODE				FB611	1-410-397-21	FERRITE	1.1 μ H
D501	8-719-404-50	DIODE MA111-TX		FB612	1-410-397-21	FERRITE	1.1 μ H
D600	8-719-510-53	DIODE D4SB60L-F		FB614	1-410-397-21	FERRITE	1.1 μ H
D601	8-719-511-40	DIODE S1VB20		FB616	1-410-397-21	FERRITE	1.1 μ H
D611	8-719-062-40	DIODE D4SBL20 μ F3		FB617	1-410-397-21	FERRITE	1.1 μ H
D612	8-719-068-00	DIODE ERC04-06SE					
			(KV-27FV300/29FV300(N)/32FV300/36FV300 ONLY)	IC			
D613	8-719-068-00	DIODE ERC04-06SE		IC600	8-759-670-30	IC MCZ3001D	
			(KV-27FV300/29FV300(N)/32FV300/36FV300 ONLY)	IC601	8-749-012-13	IC DM-58	
D614	8-719-057-52	DIODE EZ0150AV1		\triangle IC602	1-761-541-11	SELECTION UNIT, RECTIFICATION	
D615	8-719-062-40	DIODE D4SBL20 μ F3			(KV-36FV300 ONLY)		
D618	8-719-979-64	DIODE μ F4005PKG23		IC605	8-759-450-47	IC BA05T	
D620	8-719-404-50	DIODE MA111-TX		IC609	8-759-653-07	IC PQ09RD21	
D621	6-500-181-01	DIODE MA6D50		IC1405	8-759-573-40	IC TDA8580Q/N1	
D624	8-719-510-12	DIODE D10SC4M		IC1406	8-759-100-96	IC NJM4558M-TE2	
D625	8-719-510-02	DIODE D1NS4-TA2		CHIP CONDUCTOR			
D628	8-719-404-50	DIODE MA111-TX		JR1	1-216-864-11	SHORT	
D629	8-719-110-31	DIODE MTZJ-T-77-12C		JR2	1-216-864-11	SHORT	
D631	8-719-063-70	DIODE D1NL20U-TA2		JR3	1-216-864-11	SHORT	
D640	8-719-404-50	DIODE MA111-TX		JR6	1-216-864-11	SHORT	
D641	8-719-404-50	DIODE MA111-TX		JR1400	1-216-864-11	SHORT	
D645	8-719-063-70	DIODE D1NL20U-TA2		JR1401	1-216-864-11	SHORT	
D646	8-719-404-50	DIODE MA111-TX		JR1404	1-216-864-11	SHORT	
D647	8-719-063-70	DIODE D1NL20U-TA2		JR1405	1-216-864-11	SHORT	
D690	8-719-982-13	DIODE MTZJ-T-77-27		JR1409	1-216-864-11	SHORT	
D1401	8-719-929-15	DIODE MTZJ-T-77-9.1B		JR1411	1-216-864-11	SHORT	
				JR1412	1-216-864-11	SHORT	
				COIL			
				L505	1-412-529-11	INDUCTOR	22 μ H
				L604	1-412-525-31	INDUCTOR	10 μ H
				L605	1-412-519-11	INDUCTOR	3.3 μ H
				L606	1-412-519-11	INDUCTOR	3.3 μ H

NOTE: The components identified by shading and  mark are critical for safety. Replace only with part number specified.

NOTE: Les composants identifiés par un trame et une marque  sont critiques pour la sécurité. Ne les remplacer que par une pièce portant le numéro spécifique.



REF. NO.	PART NO.	DESCRIPTION	VALUES	REF. NO.	PART NO.	DESCRIPTION	VALUES
R1461	1-218-716-11	METAL CHIP	10K 0.50% 1/16W	*	4-086-349-01	CARTON, HSC (KV-36FV300 ONLY)	
R1462	1-218-716-11	METAL CHIP	10K 0.50% 1/16W				
R1481	1-216-833-11	RES-CHIP	10K 5% 1/10W		4-087-224-01	CARTON, INDIVIDUAL (KV-27FV300/29FV300 ONLY)	
R1482	1-216-829-11	RES-CHIP	4.7K 5% 1/10W				
R1487	1-216-864-11	SHORT					
RELAY							
	RY501	1-755-198-11	RELAY	*	4-085-911-01	CUSHION, FRONT (UPPER) (KV-32FV300 ONLY)	
	RY600	1-755-395-11	RELAY (AC POWER)	*	4-805-912-01	CUSHION, REAR (UPPER) (KV-32FV300 ONLY)	
				*	4-805-913-01	CUSHION, LOWER (KV-32FV300 ONLY)	
TRANSFORMER							
	T601	1-435-617-11	TRANSFORMER, LINE FILTER	*	4-086-352-01	CUSHION, FRONT (UPPER) (KV-36FV300 ONLY)	
	T603	1-437-783-11	TRANSFORMER, STAND BY (KV-27FV300/29FV300(N)/32FV300/36FV300 ONLY)	*	4-086-353-01	CUSHION, REAR (UPPER) (KV-36FV300 ONLY)	
	T603	1-437-784-11	TRANSFORMER, STAND BY (KV-29FV300(S) ONLY)	*	4-086-354-01	CUSHION, LOWER (KV-36FV300 ONLY)	
	T604	1-437-607-11	POWER ISOLATION TRANSFORMER	*	4-087-222-01	CUSHION, UPPER (KV-27FV300/29FV300 ONLY)	
	T605	1-437-785-11	TRANSFORMER ASSY POWER (HST) (KV-36FV300 ONLY)	*	4-087-223-01	CUSHION, LOWER (KV-27FV300/29FV300 ONLY)	
THERMISTOR							
THP501	1-803-540-11	THERMISTOR, POSITIVE (KV-29FV300(S) ONLY)			4-086-346-21	MANUAL, INSTRUCTION (KV-27FV300/32FV300/36FV300 ONLY)	
THP501	1-803-629-11	THERMISTOR, POSITIVE (KV-36FV300 ONLY)			4-086-346-31	MANUAL, INSTRUCTION (KV-27FV300(CND)/32FV300(CND)/36FV300(CND) ONLY)	
THP501	1-804-313-11	THERMISTOR, POSITIVE (KV-27FV300/29FV300(N)/32FV300 ONLY)			4-086-346-41	MANUAL, INSTRUCTION (KV-29FV300 ONLY)	
VARISTOR							
VDR600	1-803-585-11	VARISTOR ENE271D-10A (KV-27FV300/29FV300(N)/32FV300/36FV300 ONLY)			4-041-255-01	BAG, PROTECTION (KV-27FV300/29FV300 ONLY)	
VDR600	1-803-967-11	VARISTOR ENE621D-14A (KV-29FV300(S) ONLY)			4-066-845-02	BAG, PROTECTION (KV-32FV300 ONLY)	
				*	4-087-598-01	BAG, PROTECTION (KV-36FV300 ONLY)	
					8-953-742-90	HEADPHONE MDR-IF0230//K SET (KV-32FV300/36FV300 ONLY)	
A-1400-607-A HD BOARD, MOUNTED (KV-32FV300/36FV300 ONLY)							
ACCESSORIES AND PACKING							
*	4-041-423-01	SHEET, PROTECTION (KV-36FV300 ONLY)			4-476-668-11	REMOTE COMMANDER (RM-Y182) (KV-32FV300/36FV300 ONLY)	
	4-085-910-01	CARTON, INDIVIDUAL (KV-32FV300 ONLY)			4-476-681-11	REMOTE COMMANDER (RM-Y181) (KV-27FV300/29FV300)	
					4-978-977-11	BATTERY COVER (KV-RM-Y181/RM-Y182)	
						REMOTE COMMANDER	



A BOARD SCHEMATIC DIAGRAM

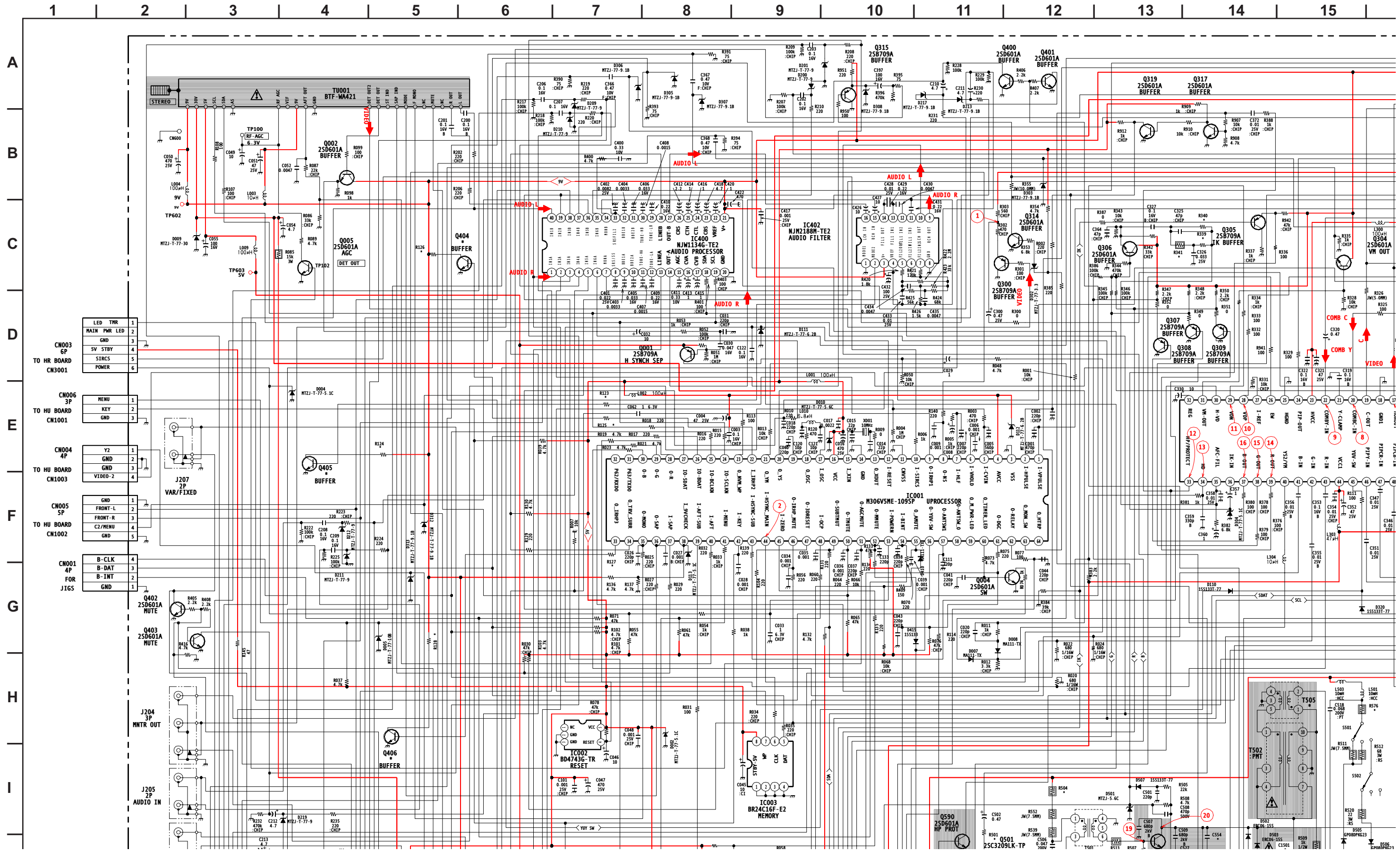

16 | 17 | 18 | 19 | 20 | 21 | 22 | 23

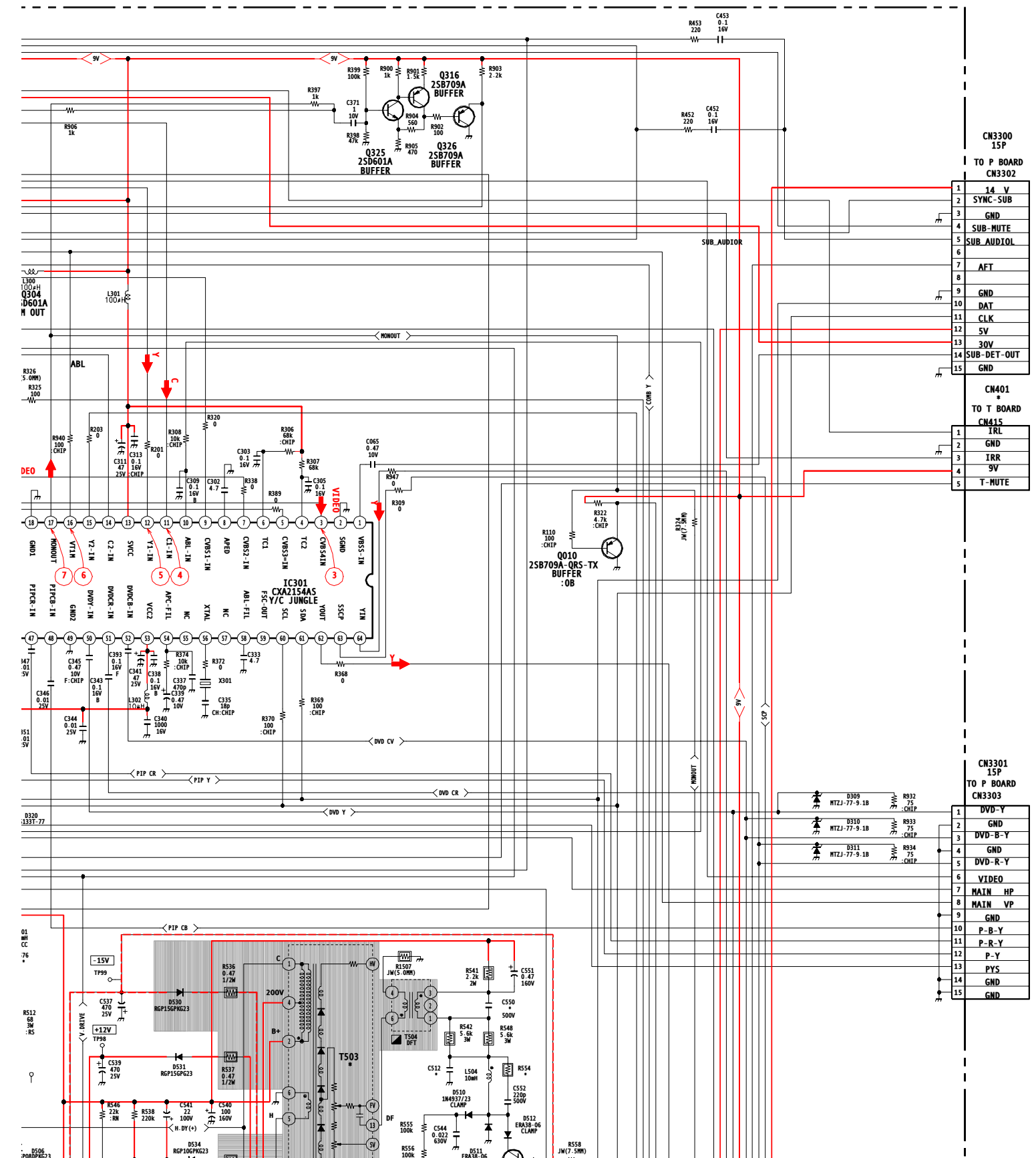

CN3300
15P
TO P BOARD
CN3302

1	14 V
2	SYNC-SUB
3	GND
4	SUB-MUTE
5	SUB-AUDTOL
6	
7	AFT
8	
9	GND
10	DAT
11	CLK
12	5V
13	30V
14	SUB-DET-OUT
15	GND

CN401
TO T BOARD
CN415

1	IRL
2	GND
3	IRR
4	9V
5	T-MUTE

CN3301
15P
TO P BOARD
CN3303

1	DVD-Y
2	GND
3	DVD-B-Y
4	GND
5	DVD-R-Y
6	VIDEO
7	MAIN HP
8	MAIN VP
9	GND
10	P-B-Y
11	P-R-Y
12	P-Y
13	PYS
14	GND
15	GND

J
K
L
M
N
O
P

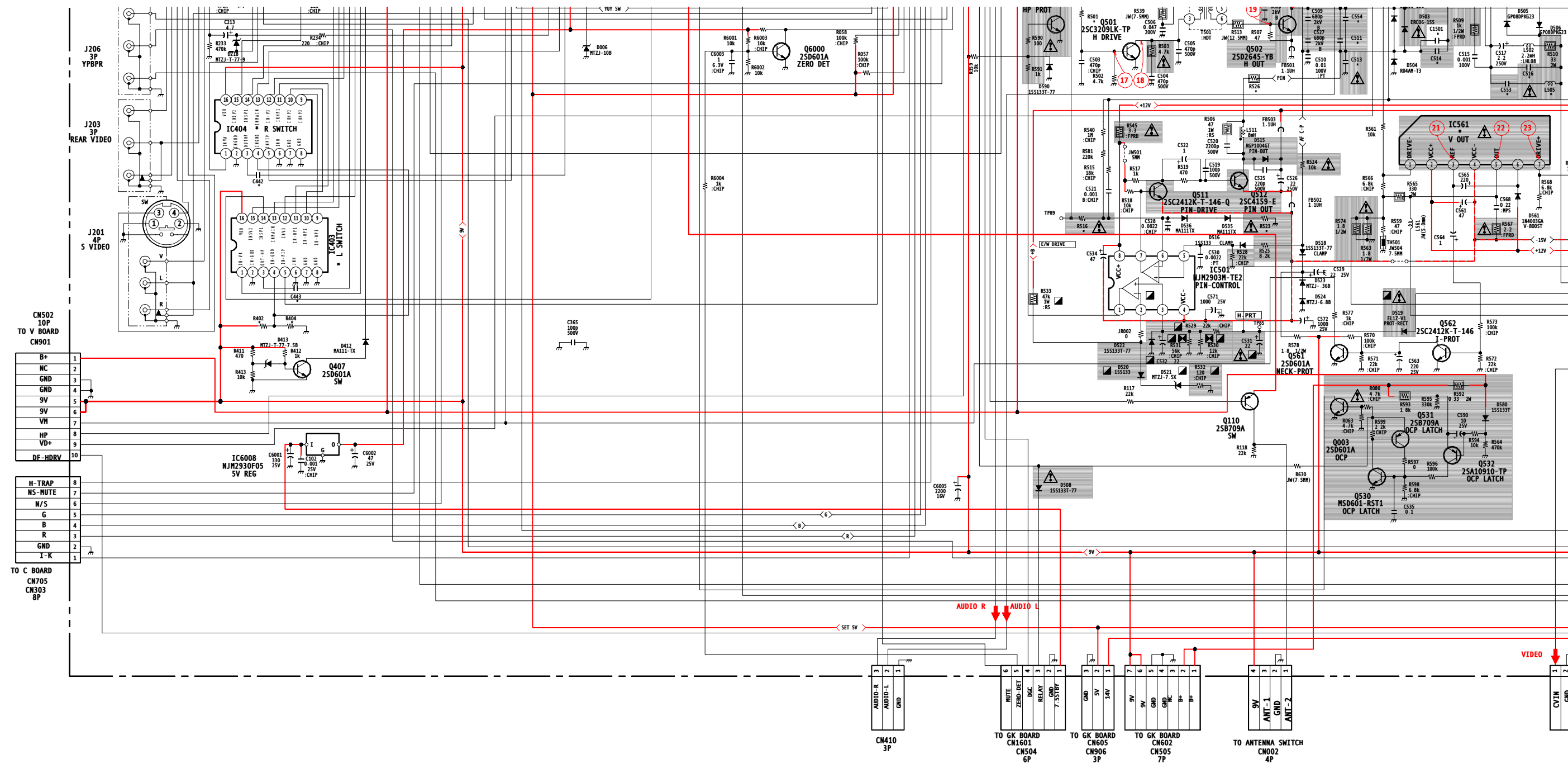

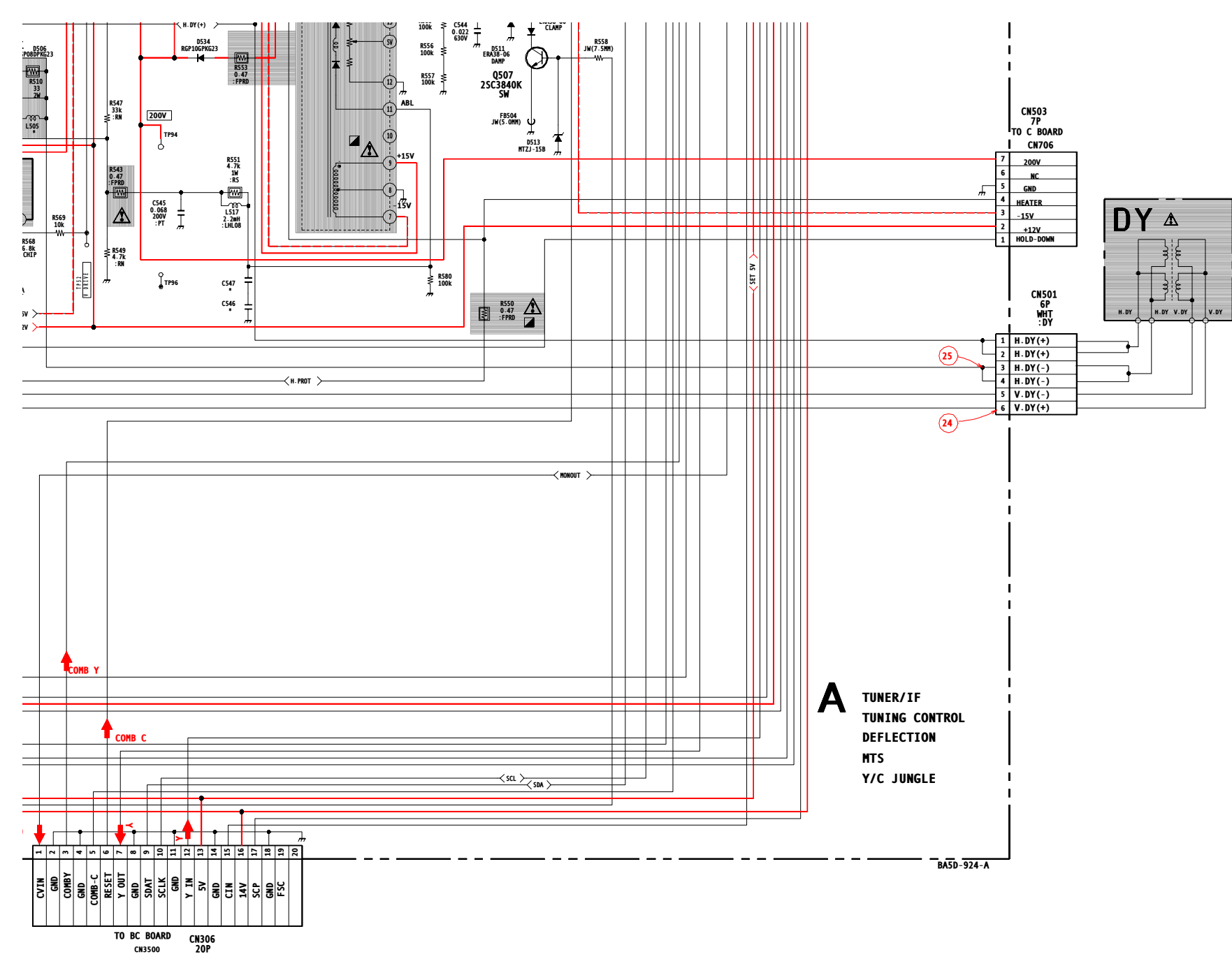

A TUNER/IF
TUNING CONTROL
DEFLECTION
MTS
Y/C JUNGLE

BASD-924-A

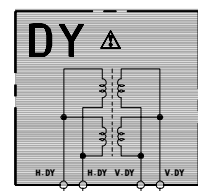

25

24

1	2	3	4	5	6	7	8	9	10	11	12	13	14	15	16	17	18	19	20
CV IN	GND	COMBY	GND	COMB-C	RESET	Y OUT	GND	SDAT	SCLK	GND	Y IN	5V	GND	CIN	14V	SCP	GND	FSC	

TO BC BOARD CN3500

PRINTING THE SERVICE MANUAL

The PDF of this service manual is not designed to be printed from cover to cover. The pages vary in size, and must therefore be printed in sections based on page dimensions.

NON-SCHEMATIC PAGES

Data that does NOT INCLUDE schematic diagrams are formatted to 8.5 x 11 inches and can be printed on standard letter-size and/or A4-sized paper.

SCHEMATIC DIAGRAMS

The schematic diagram pages are provided in two ways, full size and tiled. The full-sized schematic diagrams are formatted on paper sizes between 8.5" x 11" and 18" x 30" depending upon each individual diagram size. Those diagrams that are LARGER than 11" x 17" in full-size mode have been tiled for your convenience and can be printed on standard 11" x 17" (tabloid-size) paper, and reassembled.

TO PRINT FULL SIZE SCHEMATIC DIAGRAMS

If you have access to a large paper plotter or printer capable of outputting the full-sized diagrams, output as follows:

- 1) Note the page size(s) of the schematics you want to output as indicated in the middle window at the bottom of the viewing screen.
- 2) Go to the File menu and select Print Set-up. Choose the printer name and driver for your large format printer. Confirm that the printer settings are set to output the indicated page size or larger.
- 3) Close the Print Set Up screen and return to the File menu. Select "Print..." Input the page number of the schematic(s) you want to print in the print range window. Choose OK.

TO PRINT TILED VERSION OF SCHEMATICS



Schematic pages that are larger than 11" x 17" full-size are provided in a 11" x 17" printable tiled format near the end of the document. These can be printed to tabloid-sized paper and assembled to full-size for easy viewing.

If you have access to a printer capable of outputting the tabloid size (11" x 17") paper, then output the tiled version of the diagram as follows:

- 1) Note the page number(s) of the schematics you want to output as indicated in the middle window at the bottom of the viewing screen.
- 2) Go to the File menu and select Print Set-up. Choose the printer name and driver for your printer. Confirm that the plotter settings are set to output 11" x 17", or tabloid size paper in landscape () mode.
- 3) Close the Print Set Up screen and return to the File menu. Select "Print..." Input the page number of the schematic(s) you want to print in the print range window. Choose OK.

TO PRINT SPECIFIC SECTIONS OF A SCHEMATIC

To print just a particular section of a PDF, rather than a full page, access the Graphics Select tool in the Acrobat Reader tool bar.

- 1) To view the Graphics Select Tool, press and HOLD the mouse button over the Text Select Tool which looks like: . This tool will expand to reveal to additional tools. Choose the Graphics Select tool by placing the cursor over the button on of the far right that looks like: 
- 2) After selecting the Graphics Select Tool, place your cursor in the document window and the cursor will change to a plus (+) symbol. Click and drag the cursor over the area you want to print. When you release the mouse button, a marquee (or dotted lined box) will be displayed outlining the area you selected.
- 3) With the marquee in place, go to the file menu and select the "Print..." option. When the print window appears, choose the option under the section called "Print Range" which says "Selected Graphic".

Select OK and the output will print only the area that you outlined with the marquee. 

(continued >)

ON-SCREEN SEARCH OPTION

All of the text within the service manual PDF is content searchable. This means that you can enter any text, word, phrase or reference number that appears in the manual, and the PDF software will search, find and move the cursor to the location where you requested text first appears. This feature can be particularly useful in locating components on a specific schematic or printed wire circuit board (PWB) diagrams.

Follow these steps to effectively locate a component on a schematic diagram:

- 1) Locate the schematic you want to search by clicking on the corresponding bookmark on the left side of the screen. The view on the right of the screen will then jump to the desired schematic page.
- 2) Magnify the diagram to at least 400% before conducting a component search. This will enable you to easily view the reference number when it is highlighted on screen. To do this, click on the magnifying glass button on the tool bar at the top of the screen. Move the cursor over the diagram and RIGHT click you mouse. Select the 400% magnification option on the pop-up menu. Click on the button with the icon of the open hand to deactivate the magnification tool
- 3) Search the diagram (or the entire manual) by clicking on the binocular button tool at the top of the screen. The "Find" window will appear and allow you to type in your desired text. Type in a reference designator, such as R502, and click on the "Find" button. If the component is not on the diagram, but is listed anywhere else in the manual, the cursor will jump to the first location the text is found in the file. To find another instance of that same text, click on the binocular button again and select "Find Again."

FD Trinitron
WEGA®

Operating Instructions

WARNING

To reduce the risk of fire or electric shock, do not expose the TV to rain or moisture.



This symbol is intended to alert the user to the presence of uninsulated “dangerous voltage” within the product’s enclosure that may be of sufficient magnitude to constitute a risk of electric shock to persons.



This symbol is intended to alert the user to the presence of important operating and maintenance (servicing) instructions in the literature accompanying the appliance.

Note to the CATV Installer

This reminder is provided to call the CATV system installer’s attention to Article 820-40 of the NEC that provides guidelines for proper grounding and, in particular, specifies that the cable ground shall be connected to the grounding system of the building as close to the point of cable entry as practical.

SAFETY PRECAUTIONS

- Operate the TV only on 120 V AC.
- One blade of the power plug is wider than the other for safety purposes and will fit into the power outlet only one way. If you are unable to insert the plug fully into the outlet, contact your dealer.
- If any liquid or solid object falls into the TV, unplug it and have it checked by qualified personnel before operating it further.

CAUTION

When using TV games, computers, and similar products with your TV, keep the brightness and contrast functions at low settings. If a fixed (non-moving) pattern is left on the screen for long periods of time at a high brightness or contrast setting, the image can be permanently imprinted onto the screen. Continuously watching the same channel can cause the imprint of station logos onto the TV screen. These types of imprints are not covered by your warranty because they are the results of misuse.



To reduce the risk of electric shock, do not use this polarized plug with an extension cord, receptacle, or other outlet unless the blades can be fully inserted to prevent blade exposure.



You are cautioned that any changes or modifications not expressly approved in this manual could void your authority to operate this equipment.

NOTIFICATION

This equipment has been tested and found to comply with the limits for a Class B digital device pursuant to Part 15 of the FCC Rules. These limits are designed to provide reasonable protection against harmful interference in a residential installation. This equipment generates, uses, and can radiate radio frequency energy and, if not installed and used in accordance with the instructions, may cause harmful interference with radio communications. However, there is no guarantee that interference will not occur in a particular installation. If this equipment does cause harmful interference to radio or television reception, which can be determined by turning the equipment off and on, the user is encouraged to try to correct the interference by one or more of the following measures:

- Reorient or relocate the receiving antennas.
- Increase the separation between the equipment and receiver.
- Connect the equipment into an outlet on a circuit different from that to which the receiver is connected.
- Consult the dealer or an experienced radio/TV technician for help.

Protecting the TV

- To prevent internal heat build-up, do not block the ventilation openings.
- Do not install the TV in a hot or humid place, or in a place subject to excessive dust or mechanical vibration.

Note on Caption Vision

This television receiver provides display of television closed captioning in accordance with § 15.119 of the FCC rules.

Use of this television for other than private viewing of programs broadcast on UHF or VHF or transmitted by cable companies for the use of the general public may require authorization from the broadcaster-cable company and/or program owner.

Owner’s Record

The model and serial numbers are located on the front cover of this manual and at the rear of your TV.

Trademarks and Copyrights

ENERGY STAR® is a registered mark.

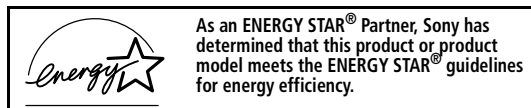

Licensed by BBE Sound, Inc. under USP 4638258.4482866. BBE and BBE symbol are trademarks of BBE Sound, Inc.

“WOW, TruSurround, and the (●) symbol are trademarks of SRS Labs, Inc. WOW technology is incorporated under license from SRS Labs, Inc.”

IMPORTANT SAFEGUARDS

For your protection, please read these instructions completely, and keep this manual for future reference. Carefully observe and comply with all warnings, cautions and instructions placed on the set, or described in the operating instructions or service manual.

WARNING

To guard against injury, the following basic safety precautions should be observed in the installation, use, and servicing of the set.

Use

Power Sources

This set should be operated only from the type of power source indicated on the serial/model plate. If you are not sure of the type of electrical power supplied to your home, consult your dealer or local power company. For those sets designed to operate from battery power, refer to the operating instructions.



Grounding or Polarization

This set is equipped with a polarized AC power cord plug (a plug having one blade wider than the other), or with a three-wire grounding type plug (a plug having a third pin for grounding).

Refer to the following instructions:

For the set with a polarized AC power cord plug

This plug will fit into the power outlet only one way. This is a safety feature. If you are unable to insert the plug fully into the outlet, try reversing the plug. If the plug still fails to fit, contact your electrician to have a suitable outlet installed. Do not defeat the safety purpose of the polarized plug by forcing it in.



Alternate Warning

For the set with a three-wire grounding type AC plug

This plug will only fit into a grounding-type power outlet. This is a safety feature. If you are unable to insert the plug into the outlet, contact your electrician to have a suitable outlet installed. Do not defeat the safety purpose of the grounding plug.

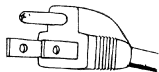

Overloading

Do not overload wall outlets, extension cords or convenience receptacles beyond their capacity, since this can result in fire or electric shock.

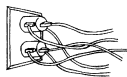

Always turn the set off when it is not to be used. When the set is left unattended and unused for long periods of time, unplug it from the wall outlet as a precaution against the possibility of an internal malfunction that could create a fire hazard.

Do not disconnect the antenna or the power cord during a heavy storm. Lightning may strike while you are holding the cable or cord, causing serious injury. Turn off your TV and wait for the weather to improve.



Object and Liquid Entry

Never push objects of any kind into the set through the cabinet slots as they may touch dangerous voltage points or short out parts that could result in a fire or electric shock. Never spill liquid of any kind on the set.



Attachments

Do not use attachments not recommended by the manufacturer, as they may cause hazards.

Do not place any objects, especially heavy objects, on top of the set. The object may fall from the top, causing injury.

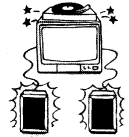

Cleaning

Unplug the set from the wall outlet before cleaning or polishing it. Do not use liquid cleaners or aerosol cleaners. Use a cloth lightly dampened with water for cleaning the exterior of the set.



If a snapping or popping sound from a TV set is continuous or frequent while the TV is operating, unplug the TV and consult your dealer or service technician. It is normal for some TV sets to make occasional snapping or popping sounds, particularly when being turned on or off.



Installation

Always use two or more people to lift or move the set. The set is heavy and the bottom surface is flat. Serious injury can result from trying to move the set by yourself alone, or from unsteady handling.

Install the set on a stable, level surface.

Water and Moisture

Do not use power-line operated sets near water — for example, near a bathtub, washbowl, kitchen sink, or laundry tub, in a wet basement, or near a swimming pool, etc.



Accessories

Do not place the set on an unstable cart, stand, tripod, bracket, table, or shelf. The set may fall, causing serious injury to a child or an adult, and serious damage to the set. Use

only a cart or stand recommended by the manufacturer for the specific model of TV. Any mounting of the product should follow the manufacturer's instructions, and should use a mounting accessory recommended by the manufacturer. An appliance and cart combination should be moved with care. Quick stops, excessive force, and uneven surfaces may cause the appliance and cart combination to overturn.



Ventilation

The slots and openings in the cabinet and in the back or bottom are provided for necessary ventilation. To ensure reliable operation of the set, and to protect it from overheating, these slots and openings must never be blocked or covered.

- Never cover the slots and openings with a cloth or other materials.



- Never block the slots and openings by placing the set on a bed, sofa, rug or other similar surface.

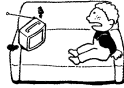

- Never place the set in a confined space, such as a bookcase or built-in cabinet, unless proper ventilation is provided.



- Do not place the set near or over a radiator or heat register, or where it is exposed to direct sunlight.



Power-Cord Protection

Do not allow anything to rest on or roll over the power cord, and do not place the set where the power cord is subject to wear or abuse.



Grounding or Polarization

This set may be equipped with a polarized alternating current line plug (a plug having one blade wider than other). This plug will fit into the power outlet only one way. This is a safety feature. If you are unable to insert the plug fully into the outlet, try reversing the plug. If the plug still fails to fit, contact your electrician to replace your obsolete outlet. Do not defeat the safety purpose of the polarized plug.

Antennas

Outdoor Antenna Grounding

If an outdoor antenna is installed, follow the precautions below. An outdoor antenna system should not be located in the vicinity of overhead power lines or other electric light or power circuits, or where it can come in contact with such power lines or circuits.

WHEN INSTALLING AN OUTDOOR ANTENNA SYSTEM, EXTREME CARE SHOULD BE TAKEN TO KEEP FROM CONTACTING SUCH POWER LINES OR CIRCUITS AS CONTACT WITH THEM IS ALMOST INVARIABLY FATAL.

Be sure the antenna system is grounded so as to provide some protection against voltage surges and built-up static charges. Section 810 of the National Electrical Code (NEC) in USA and Section 54 of the Canadian Electrical Code in Canada provides information with respect to proper grounding of the mast and supporting structure, grounding of the lead-in wire to an antenna discharge unit, size of grounding conductors, location of antenna discharge unit, connection to grounding electrodes, and requirements for the grounding electrode.

Antenna Grounding According to the NEC

Antenna Grounding According to the National Electrical Code, ANSI/NFPA 70.

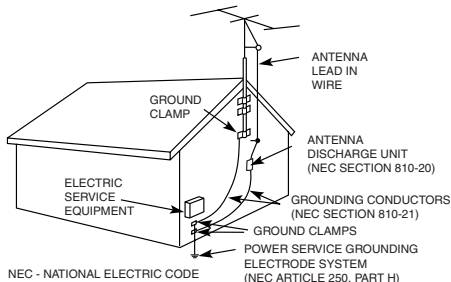

NEC - NATIONAL ELECTRIC CODE

Lightning

For added protection for this television receiver during a lightning storm, or when it is left unattended and unused for long periods of time, unplug it from the wall outlet and disconnect the antenna. This will prevent damage to the receiver due to lightning and power-line surges.

Service

Damage Requiring Service

Unplug the set from the wall outlet and refer servicing to qualified service personnel under the following conditions:

- When the power cord or plug is damaged or frayed.



- If liquid has been spilled into the set or objects have fallen into the product.



- If the set has been exposed to rain or water.



- If the set has been subject to excessive shock by being dropped, or the cabinet has been damaged.

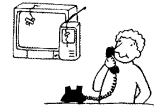

- If the set does not operate normally when following the operating instructions. Adjust only those controls that are specified in the operating instructions. Improper adjustment of other controls may result in damage and will often require extensive work by a qualified technician to restore the set to normal operation.



- When the set exhibits a distinct change in performance — this indicates a need for service.

Servicing

Do not attempt to service the set yourself since opening the cabinet may expose you to dangerous voltage or other hazards. Refer all servicing to qualified service personnel.



Replacement Parts

When replacement parts are required, be sure the service technician certifies in writing that he has used replacement parts specified by the manufacturer that have the same characteristics as the original parts. Unauthorized substitutions may result in fire, electric shock, or other hazards.



Safety Check

Upon completion of any service or repairs to the set, ask the service technician to perform routine safety checks (as specified by the manufacturer) to determine that the set is in safe operating condition, and to so certify. When the set reaches the end of its useful life, improper disposal could result in a picture tube implosion. Ask a qualified service technician to dispose of the set.



Contents

Introduction

Introducing the FD Trinitron WEGA® Features.....	1
About this Manual.....	2
Batteries for the Remote Control.....	2
Front Panel Menu Controls.....	2
Using the Remote Controls.....	3

Connecting Your TV

TV Rear Panel.....	8
Basic Connections.....	10
Cable Box Connections.....	11
Connecting Additional Equipment.....	13

Using Basic Functions

Setting Up the TV Automatically.....	21
Quick Start to the Menus.....	22
Using Picture in Picture (PIP) with Remote Y181.....	24
Using Picture in Picture (PIP) with Remote Y182.....	26
Setups that Affect Your Ability to Use PIP.....	28
Using Wireless Headphones.....	29

Using the Menus

How to access menus with Remote Control Y182.....	33
How to access menus with Remote Control Y181.....	33
Using the Video Menu.....	34
Using the Audio Menu.....	35
Using the Channel Setup Menu.....	37
Using the Parent Menu.....	39
Using the Timer Menu.....	45
Using the Setup Menu.....	46
Using the Basic Menu.....	47

Other Information

Programming the Remote Control.....	49
Troubleshooting.....	52
Specifications.....	55

Index.....	57
-------------------	-----------

Introduction

Congratulations on your purchase of the Sony FD Trinitron WEGA®. Before you begin using this manual, please check the model number located on the rear of your TV or on the front cover of this manual.

Introducing the FD Trinitron WEGA® Features

Some of the features you will enjoy include:

- ❑ **FD Trinitron Flat CRT** — Technologically advanced tube delivers a picture with uncompromising accuracy and outstanding image detail.
- ❑ **Y, P_b, P_r Inputs** — A component video input connection for a superior picture quality (480i only).
- ❑ **WOW** — A new audio feature that provides a dramatic presence with a full, deep bass sound. When WOW is enabled, BBE is directly activated to further enhance the audio performance.
- ❑ **TruSurround** — Produces a dynamic three dimensional sound for stereo audio signals.
- ❑ **Parental Control (V-Chip)** — A tool to help parents monitor what their children watch on TV by establishing rating limits.
- ❑ **Wireless Infrared Headphones** — Enjoy the privacy of listening to your favorite programs without disturbing anyone else (for KV-32FV300 and KV-36FV300 only).
- ❑ **ClearEdge VM** — Sharpens picture definition to give objects a sharp, clean edge.
- ❑ **DynaBlack** — Improves contrast and sharpens image detail.
- ❑ **Picture in Picture (PIP)** — Allows you to view two programs simultaneously.
- ❑ **Favorite Channels** — Instant access to your favorite channels with the touch of a button.
- ❑ **Info Banner** — A new, convenient feature that displays the name and the remaining time of the current program viewed, if available.
- ❑ **Universal Remote Control** — Program your remote control to operate your connected cable box, VCR, digital satellite receiver, or DVD player.
- ❑ **Energy Star®** — Meets the Energy Star guidelines for energy efficiency.
- ❑ **Front Panel Controls** — Allows access to the on-screen menus without the use of a remote control.
- ❑ **Front A/V Inputs** — A quick connection for video games, camcorders or stereo/mono equipment.

About this Manual

This manual provides instructions to help you enjoy your new TV. It shows you how to connect to an antenna or cable, cable box, VCR, DVD, satellite receiver, stereo system, or camcorder. Once you're connected, follow the instructions and use the remote control to access the on-screen menus.

Batteries for the Remote Control

Insert two AA (R6) batteries (supplied) into the remote control using the following illustration as a guide.

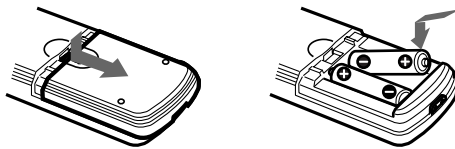



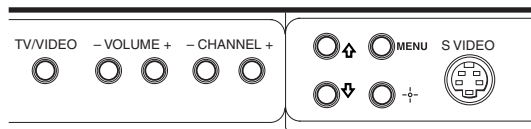

 Under normal conditions, batteries will last up to six months. If the remote control does not operate properly, the batteries might be worn out.

 If you will not be using the remote control for an extended period of time, remove the batteries to avoid possible damage from battery leakage.

Front Panel Menu Controls



The front Audio/Video panel controls allows you to access the menu without the remote control.



- Press  to display the on-screen menu.
- Use the  and  buttons on the front Audio/Video panel instead of your remote control.
- Use the  button on the front Audio/Video panel to navigate , then select an item. The front panel controls also allows you to change your channels CH+/-, adjust the volume VOL +/-, and change video inputs.







 To navigate the menus with your remote control, see "Using the Menus" on page 33.

Using the Remote Controls

Model RM-Y181

For KV-27FV300 model

Button	Description
1 MUTING	Press to turn off the sound. Press again or press  to restore sound.
2 SYSTEM OFF	Press to power off the equipment programmed into the remote control, see "Programming the Remote Control" on page 49.
3 TV/VCR	Press to switch between TV and VCR mode. If you have a non-Sony VCR, you will need to program the remote control to recognize your VCR. For details, see "Programming the Remote Control" on page 49.
4 ANT (antenna)	Press to change from VHF/UHF input to the AUX input, press again to switch back.
5 PICTURE MODE	Press repeatedly to step through the available video picture modes: Vivid, Standard, Movie and Sports. Also available in the Video menu. See "Using the Video Menu" on page 34 for details.
6 SLEEP	Press repeatedly until the TV displays the time in minutes (15, 30, 45, 60, or 90) that you want the TV to remain on before shutting off automatically. Cancel by pressing until Sleep Off appears. While Sleep feature is set, press once to view remaining time.
7 JUMP	Press to jump back and forth between two channels. The TV alternates between the current channel and the last channel that was selected.
8 TV/SAT	Press to switch between the TV and SAT (satellite) inputs when in SAT FUNCTION mode.
	Press for a direct selection of Effect settings (Simulated, WOW, TruSurround, Off), when the remote is in TV FUNCTION mode. See "Using the Audio Menu" on page 35 for details.
9 RESET	Press to return to factory settings while in an on-screen menu.
10 VOL (volume)	Press (+) or (-) to adjust the volume.
11 CODE SET	Use to program your remote control to operate connected video equipment. See "Programming the Remote Control" on page 49.

Button	Description
12 POWER buttons	Press to turn on and off the TV and other audio/video equipment you have programmed into the remote control. For instructions, see "Programming the Remote Control" on page 49.
13 FUNCTION buttons	Press to select the equipment (TV, VCR/DVD, SAT/CABLE) that you want to operate with the remote control. The indicator (LED) lights up momentarily when pushed to show which device the remote control is operating.
14 PIP (Picture in Picture)	Operates PIP feature. See "Using Picture in Picture (PIP) with Remote Y181" on page 24.
VCR (operating)	Operates your VCR. The VCR must be programmed into the remote control. For instructions, see "Programming the Remote Control" on page 49.
REC	Press  button and the  button - above left - at the same time to record any programs with your VCR (the remote control must be programmed in order to use REC.)
	Fast-forward.
	Play.
	Stop.
	Pause. Press again to resume normal playback.
15 TV/VIDEO	Press to cycle through available video inputs.
16 DISPLAY	Press once to display the current time and program status (such as channel number, channel label (if set), video input, and video label). Press again to turn display off.
17 MTS/SAP	Press to cycle through the Multi-channel TV Sound (MTS) options: Stereo, Auto SAP (Second Audio Programming), and Mono.
18 0-9 and ENTER	Press to change channels directly. The channel changes after 2 seconds.
19 GUIDE	Press to display the program guide of your satellite antenna.
20	
21 MENU	Press the arrow buttons to move the cursor in the on-screen menus. Press the center button to select or access an option.
22 CH (channel)	Press to display the on-screen menu. Press again to exit the menu at any time.
CH (channel)	Press to change channels. To scan rapidly through the channels, press and hold down the CH+ or CH- button.

 For information on Picture in Picture (PIP) operation buttons, see page 25.

 If you lose your remote control, see page 54.



Model RM-Y182

For KV-32FV300, KV-36FV300 models

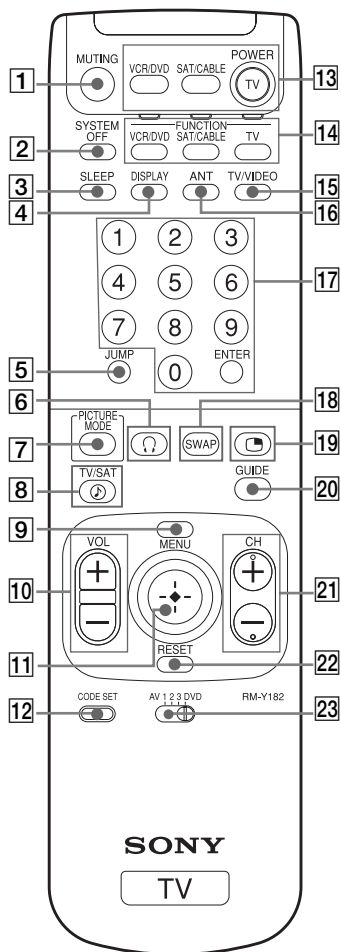
Outside Panel







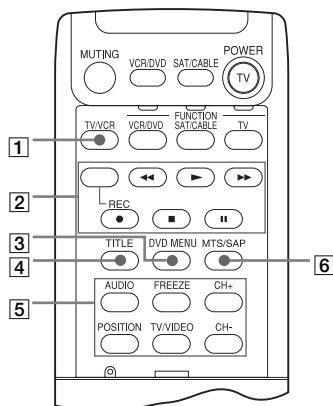

Button	Description
1 MUTING	Press to turn off the sound. Press again or press to restore the sound.
2 SYSTEM OFF	Press to power off the equipment programmed into the remote control, see "Programming the Remote Control" on page 49.
3 SLEEP	Press repeatedly until the TV displays the time in minutes (15, 30, 45, 60, or 90) that you want the TV to remain on before shutting off automatically. Cancel by pressing until Sleep Off appears. While Sleep feature is set, press once to view remaining time.
4 DISPLAY	Press once to display the current time and program status (such as channel number, channel label (if set), video input, and video label). Press again to turn display off.
5 JUMP	Press to jump back and forth between two channels. The TV alternates between the current channel and the last channel that was selected.
6 	Press to turn the headphones on and off.
7 PICTURE MODE	Press repeatedly to step through the available video picture modes: Vivid, Standard, Movie and Sports. Also available in the Video menu. See "Using the Video Menu" on page 34 for details.
8 TV/SAT	Press to switch between the TV and SAT (satellite) inputs when in SAT FUNCTION mode.
8 	Press for a direct selection of Effect settings (Simulated, WOW, TruSurround, Off), when the remote is in TV FUNCTION mode. See "Using the Audio Menu" on page 35 for details.
9 MENU	Press to display the on-screen menu. Press again to exit the menu at any time.
10 VOL (volume)	Press (+) or (-) to adjust the volume.
11 	Use the joystick to move the on-screen cursor. Press down on the center of the joystick to select the item.
12 CODE SET	Use to program your remote control to operate connected video equipment. See "Programming the Remote Control" on page 49.

	Button	Description
13	POWER buttons	Press to turn on and off the TV and other audio/video equipment you have programmed into the remote control. For instructions, see "Programming the Remote Control" on page 49.
14	FUNCTION buttons	Press to select the equipment (TV, VCR/DVD, SAT/CABLE) that you want to operate with the remote control. The indicator (LED) lights up momentarily when pushed to show which device the remote control is operating.
15	TV/VIDEO	Press to cycle through available video inputs.
16	ANT (antenna)	Press to change between the VHF/UHF input to the AUX input, press again to switch back.
17	0-9 and ENTER	Press to change channels directly. The channel changes after 2 seconds.
18		See "Using Picture in Picture (PIP) with Remote Y182" on page 26 for details.
19		See "Using Picture in Picture (PIP) with Remote Y182" on page 26 for details.
20	GUIDE	Press to display the program guide of your satellite antenna.
21	CH (channel)	Press to change channels. To scan rapidly through the channels, press and hold down the CH+ or CH- button.
22	RESET	Press to return to the factory settings while in an on-screen menu.
23	AV 1 2 3 DVD 	Use to switch control for connected video equipment. You can program one video source for each switch position. For details, see "Programming the Remote Control" on page 49.

 If you lose your remote control, see page 54.

Inside Panel



Button	Description
1 TV/VCR	Press to switch between TV and VCR mode. If you have a non-Sony VCR, you will need to program the remote control to recognize your VCR. For details, see "Programming the Remote Control" on page 49.
2 VCR (operating)	Operates your VCR. The VCR must be programmed into the remote control. For instructions, see "Programming the Remote Control" on page 49.
	Rewind.
REC	Press the  button and the blank button - above, left - at the same time to record any programs with your VCR (the remote control must be programmed in order to use REC.)
	Fast-forward.
	Play.
	Stop.
	Pause. Press again to resume normal playback.
3 DVD MENU	Press to display the DVD's menu.
4 TITLE	Press to display the DVD's Title menu.
5 PIP (Picture in Picture)	Press to operate PIP feature. See "Using Picture in Picture (PIP) with Remote Y182" on page 26.
6 MTS/SAP	Press to cycle through the Multi-channel TV Sound (MTS) options: Stereo, Auto SAP (Second Audio Programming), and Mono.

Connecting Your TV

Read this section before setting up your TV for the first time. This section covers basic connections in addition to any optional equipment you may be connecting.

TV Rear Panel

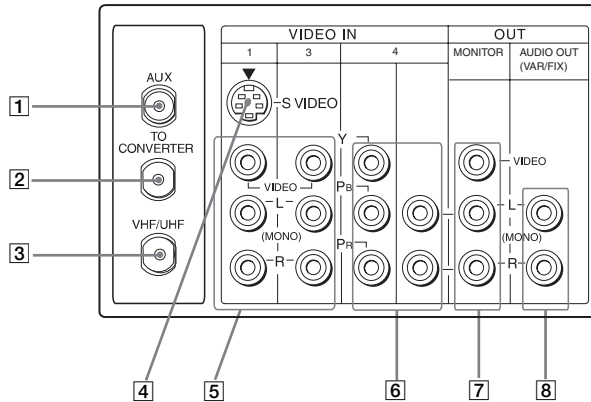

Jack	Description
1 AUX	Allows you to view local and cable channels if your cable provider does not feature local channels. You can switch between local and cable channels easily by pressing ANT on the remote control. Devices connected to the AUX input cannot be viewed in PIP.
2 TO CONVERTER	This is a VHF/UHF out jack that lets you set up your TV to switch between scrambled channels (through a cable box) and normal cable channels (CATV). Use this jack instead of a splitter to get better picture quality when you need to switch between scrambled and unscrambled cable channels.
3 VHF/UHF	Connects to your VHF/UHF antenna or cable.
4 S VIDEO	Connects to the S VIDEO OUT jack on your VCR or other video equipment that has S VIDEO. S VIDEO provides better picture quality than the VHF/UHF jacks or the video input jack. S VIDEO does not provide sound; you still must connect the audio cables.

Jack	Description
5 AUDIO (L/R)/VIDEO	Connects to the AUDIO and VIDEO output jacks on your VCR or other video equipment. A third video input jack (VIDEO 2) is located on the front panel of the TV. These AUDIO/VIDEO input jacks provide better picture quality than the VHF/UHF jack.
6 Y, P_B, P_R/ L, R	Connects to the component video Y, P _B , P _R , and AUDIO L and R jacks on your DVD player or digital set-top box (480i only).
7 MONITOR OUT	Lets you record the program you are watching to a VCR. When two VCRs are connected (see “Connecting Two VCRs for Tape Editing” on page 15), you can use your TV as a monitor for tape-to-tape editing.
8 AUDIO OUT (VAR/FIX) L(MONO)/R	Connects to the AUDIO L and R input jacks on your audio or video equipment. You can listen to your TV’s audio through your stereo system.

Basic Connections

TV with Indoor or Outdoor Antenna, or CATV Cable

Depending on the cable available in your home, choose one of the connections below:

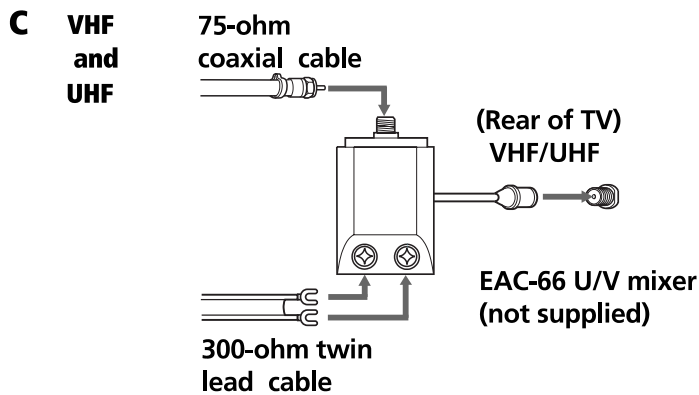
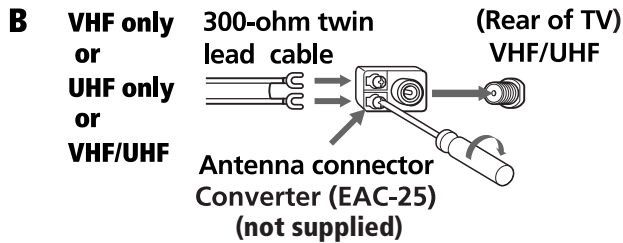
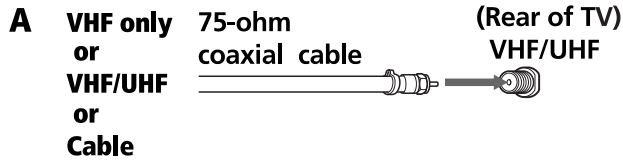

 If you are connecting to an indoor or outdoor antenna, you may need to adjust the orientation of the antenna for best reception.

Cable Box Connections

Some cable TV systems use scrambled or encoded signals that require a cable box to view all channels. If you subscribe to that kind of cable service, use this connection. Scrambled signals coming in to the TV through the cable box cannot be viewed in PIP. If some of your channels are scrambled, consider using the Cable Box and Cable connection.

Cable Box and TV

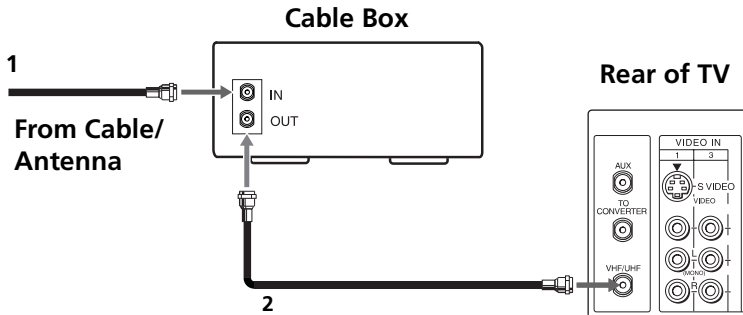

- 1** Connect the coaxial cable from your cable service to the IN jack on your cable box.
- 2** Connect a coaxial cable (not supplied) from the OUT jack on your cable box to the VHF/UHF jack on your TV.

 If you will be controlling all channel selection through your cable box, you should consider using the Channel Fix feature to set your TV to channel 3 or 4 (see page 37).

Cable Box and Cable

Use this connection if you subscribe to a cable system that scrambles some channels (pay channels) but not all of them. This setup allows you to use the remote control to:

- ❑ change channels through your cable box when you are receiving a scrambled signal
- ❑ change channels through your TV

This connection also allows you to use the PIP feature when you are viewing unscrambled channels coming directly into your TV from your cable. Scrambled signals coming through the cable box cannot be viewed in PIP. For more information on the PIP feature, see page 24 or 26.

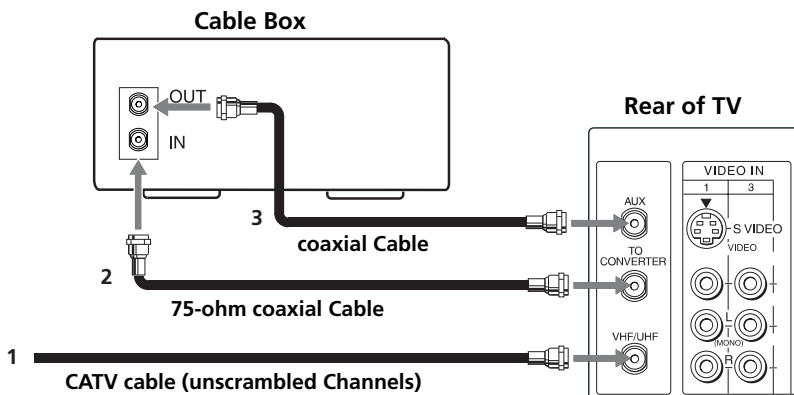

- 1** Connect the coaxial cable from your cable service to the VHF/UHF jack on your TV.
- 2** Using a coaxial cable (not supplied), connect the IN jack on your cable box to the TO CONVERTER jack on your TV.
- 3** Using a coaxial cable (not supplied), connect the OUT jack on your cable box to the AUX jack on your TV.

Press the ANT button on the remote control to switch between the cable box and direct cable inputs.

Your Sony remote control can be programmed to operate your cable box (see page 50).

To use the cable box to change your channels, set your TV to channel 3 or 4. Use the Channel Fix feature to ensure that you don't accidentally switch channels using your TV (see page 37).

Connecting Additional Equipment

Connecting a TV and VCR

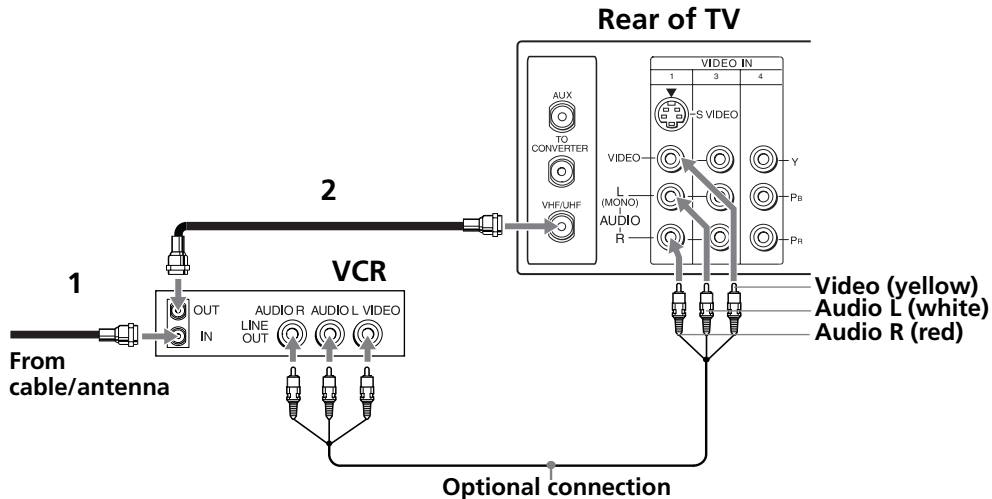

To watch video programs from your VCR, tune your TV to channel 3 or 4 (as set on the rear of your VCR).

- 1** Connect the coaxial cable from your TV antenna or cable service to the IN jack on your VCR.
- 2** Connect a coaxial cable (not supplied) from the OUT jack on your VCR to the VHF/UHF jack on the TV.

Optional connection

If your VCR is equipped with video outputs, you can get better picture quality by connecting audio/video cables (not supplied) from AUDIO and VIDEO OUT on your VCR to AUDIO/VIDEO IN on your TV.

You can use the button to switch between the VHF/UHF and VIDEO inputs.

For better picture quality, use S VIDEO instead of the yellow audio/video cable. S VIDEO does not provide sound; you still must connect the audio cables.

Connecting a TV, VCR, and Cable Box

Use this connection if you subscribe to a cable system that scrambles some channels (pay channels), but not all of them. This setup allows you to use the remote control to:

- ❑ change channels through your cable box or VCR when you are receiving a scrambled signal
- ❑ change channels through your TV

This connection also allows you to use the PIP feature when you are viewing unscrambled channels coming directly into your TV from your cable. Scrambled signals coming through the cable box cannot be viewed in PIP. For more information on the PIP feature, see page 24 or 26.

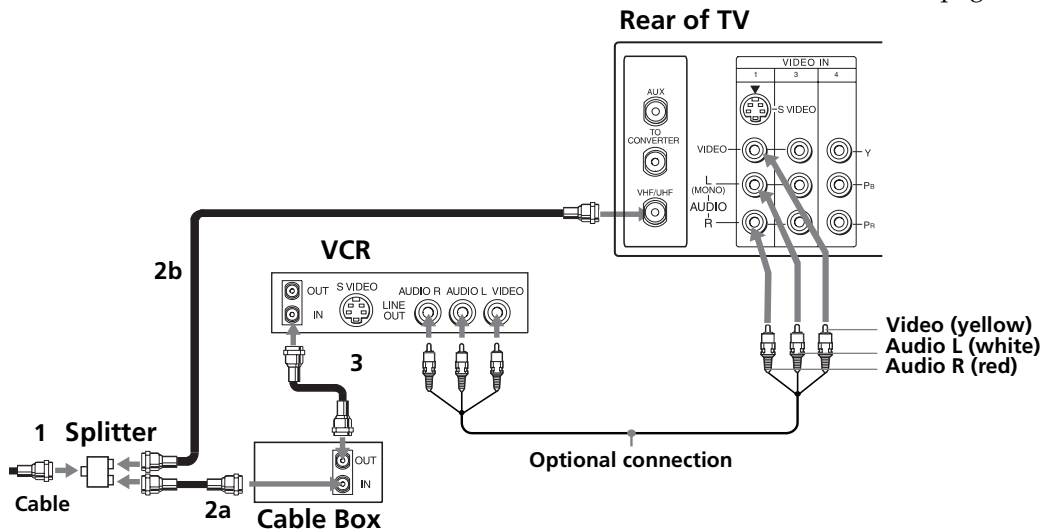



- 1** Connect the single input jack of the splitter to your incoming cable connection.
- 2** Using a coaxial cable (not supplied), connect the two output jacks of the splitter to:
 - a)** the IN jack on your cable box, and
 - b)** the VHF/UHF jack on the TV.
- 3** Using a coaxial cable (not supplied), connect the OUT jack on your cable box to the IN jack on your VCR.

If you will be controlling all channel selections through your cable box, you should consider using the Channel Fix feature to set your TV to channel 3 or 4 (see page 37).

Optional connection

If your VCR is equipped with video outputs, you can get better picture quality by connecting audio/video cables (not supplied) from AUDIO and VIDEO OUT on your VCR to AUDIO/VIDEO IN on your TV.

 For better picture quality, use S VIDEO instead of the yellow audio/video cable. S VIDEO does not provide sound; you still must connect the audio cables.

 You can use the  button to switch between the VHF/UHF and VIDEO inputs.

Connecting Two VCRs for Tape Editing

You can connect two VCRs together to edit video tapes. You can also connect both VCRs to your TV to view the program being recorded.

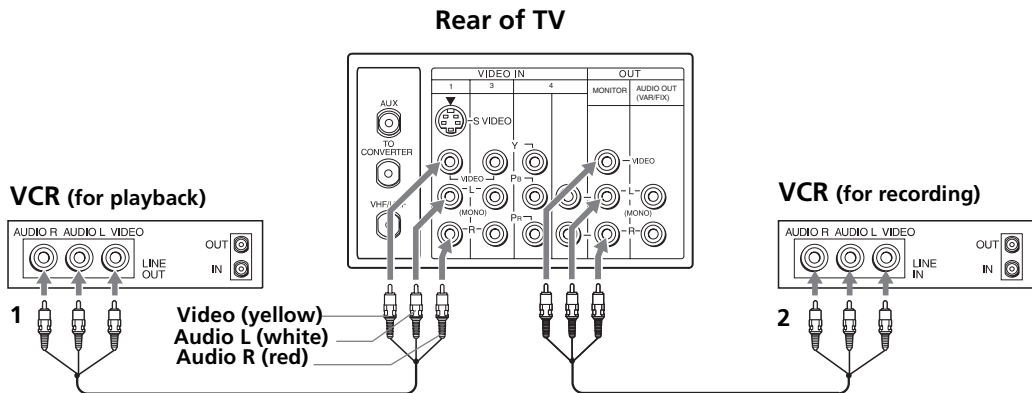

- 1** Using audio/video cables (not supplied), connect AUDIO and VIDEO OUT on your first VCR to AUDIO and VIDEO IN on your TV.
- 2** Using audio/video cables (not supplied), connect AUDIO and VIDEO IN on the second VCR to the MONITOR AUDIO and VIDEO OUT on your TV.

 To perform tape editing, set the TV to the video input intended for playback by pressing .

Connecting a TV and Satellite Receiver

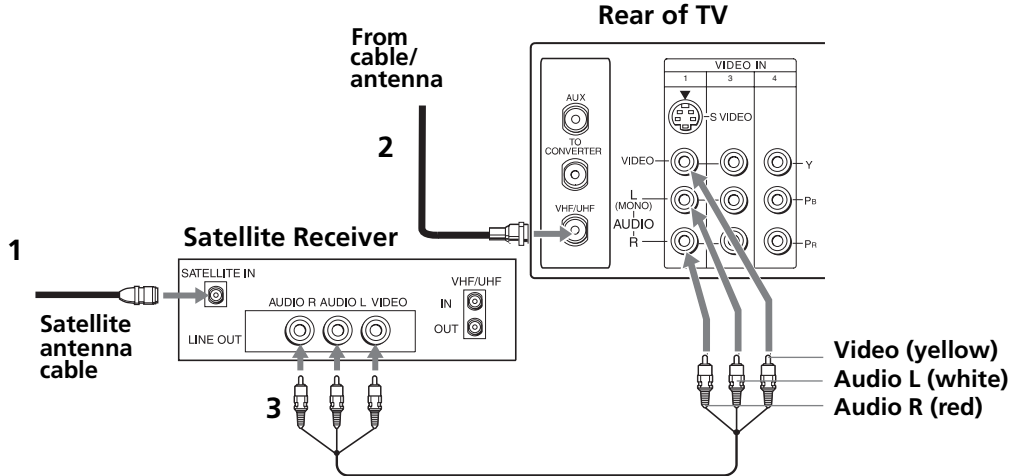

- 1** Connect the cable from your satellite antenna to SATELLITE IN on your satellite receiver.
- 2** Connect the coaxial cable from your cable service or antenna to the VHF/UHF jack on your TV.
- 3** Using audio/video cables (not supplied), connect AUDIO and VIDEO OUT on your satellite receiver to AUDIO and VIDEO IN on your TV.

You can use the button to switch between the VHF/UHF and VIDEO inputs.

For better picture quality, use S VIDEO instead of the yellow audio/video cable. S VIDEO does not provide sound; you still must connect the audio cables.

Connecting a TV, Satellite Receiver, and VCR

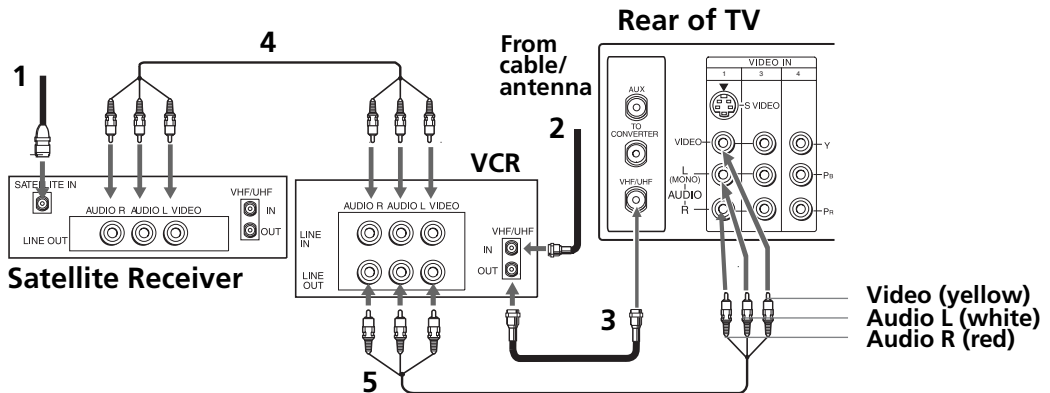

- 1** Connect the coaxial cable from your satellite antenna to SATELLITE IN on the satellite receiver.
- 2** Connect the coaxial cable from your cable service or antenna to the IN jack on your VCR.
- 3** Using a coaxial cable (not supplied), connect the OUT jack on your VCR to the VHF/UHF jack on your TV.
- 4** Using audio/video cables (not supplied), connect AUDIO and VIDEO OUT on your satellite receiver to AUDIO and VIDEO IN on your VCR.
- 5** Using audio/video cables (not supplied), connect AUDIO and VIDEO OUT on your VCR to AUDIO and VIDEO IN on your TV.

 To view from the satellite receiver or VCR, select the video input to which your satellite receiver or VCR is connected by pressing TV/VIDEO on the remote control.

Connecting a DVD Player

Using audio/video cables (not supplied), connect AUDIO and VIDEO OUT on your DVD player to AUDIO and VIDEO IN on your TV.

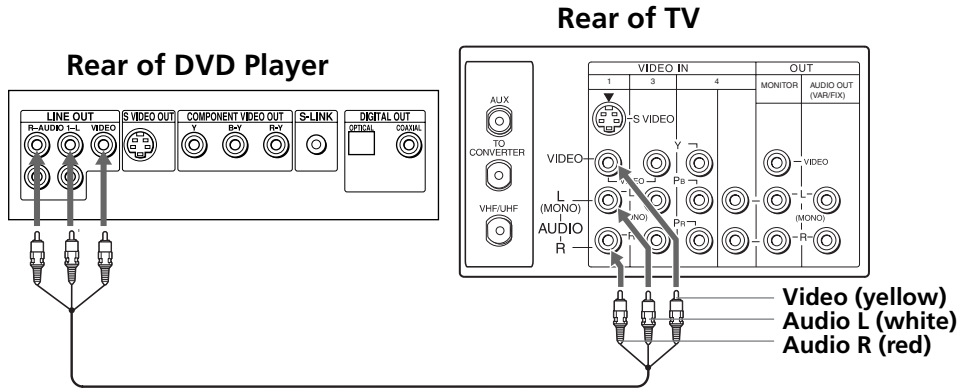

For better picture quality, use S VIDEO instead of the yellow Audio/Video cable. S VIDEO does not provide sound; you still must connect the audio cables.

Optional connection

If your DVD player is equipped with component video outputs (Y, P_B, P_R), you can improve the picture quality by using component video cables (480i only).

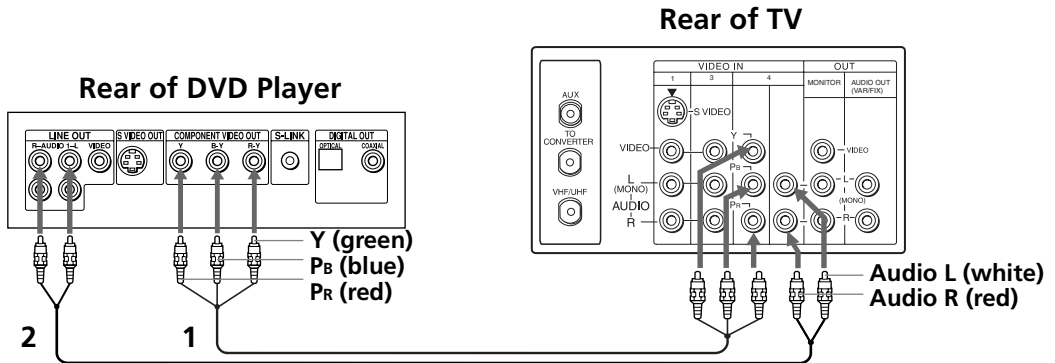

- 1 Using component video cables (not supplied), connect the Y, P_B, P_R OUT on your DVD player to Y, P_B, P_R IN on your TV.
- 2 Connect AUDIO OUT on your DVD player to AUDIO IN on your TV.

The Y, P_B, P_R outputs on your DVD player are sometimes labeled Y, C_B, and C_R or Y, B-Y, and R-Y. If so, connect the cables to like colors.

Connecting a Camcorder

Using audio/video cables (not supplied), connect AUDIO and VIDEO OUT on your camcorder to AUDIO and VIDEO IN on your TV.

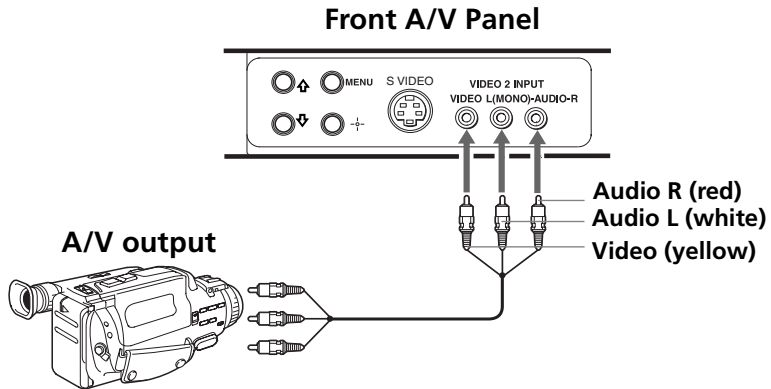

If the camcorder has an S VIDEO jack, you can use an S VIDEO cable to improve picture quality; replace the yellow video cable of the combination Audio/Video cable with the S VIDEO cable. You will still need audio cables for sound.

Connecting an Audio System

Using audio cables (not supplied), connect AUDIO OUT on your TV to one of the unused line inputs (e.g. TV, AUX, TAPE2) on your stereo.

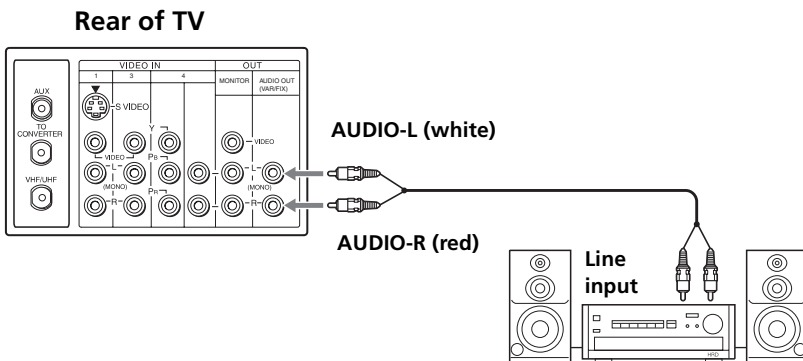

Set your stereo to the selected line input. See "Using the Audio Menu" on page 35 for additional audio setup instructions.

Using Basic Functions



Setting Up the TV Automatically

After you have finished connecting your TV, you can perform Auto Program to set up your channels. When Auto Programming, the TV will automatically search for available channels and program receivable channels.

 The direction in this manual will refer to the remote control that incorporates a joystick (RM-Y182). See "Using the Remote Control" on page 3 for further details on this remote.

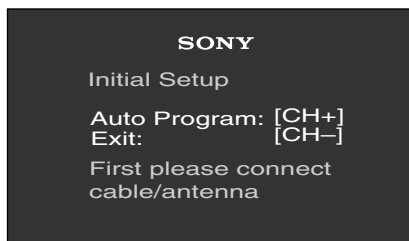



- 1 Press  to turn on the TV. The Initial Setup screen appears.





- 2 Press  on the remote control or on the TV front panel to perform Auto Program, or press  to exit.

 The Initial Setup screen appears each time you turn on the TV until you perform Auto Program.

To perform Auto Program again



- 1 Press .
- 2 Use the joystick to highlight Channel Setup Menu.
- 3 Use the joystick to scroll down to highlight Cable. Press  to select.
- 4 Use the joystick to scroll up and down select On or Off according to how you connected your TV. Press .
- 5 Use the joystick to highlight Auto Program. Press  to search for channels.
- 6 After performing Auto Program, press  to exit.

To reset the TV to factory settings

- 1 Turn the TV on.
- 2 Hold down  on the remote control.
- 3 Press and release the POWER button on the TV front panel. (The TV will turn itself off, then back on.)
- 4 Release .

Quick Start to the Menus

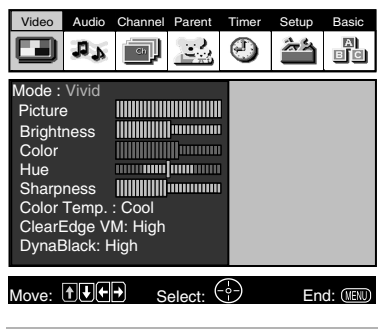
The following settings are available in your on-screen menus. For more details on how to use the menus, see “Using the Menus” on page 33.

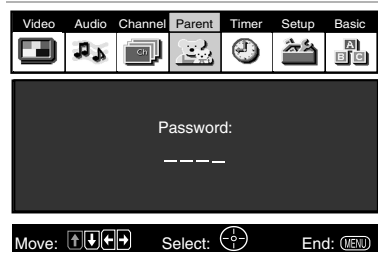
Menu	Allows you to
	<p>Make adjustments to your picture settings.</p>
	<p>Change your audio settings.</p>
	<p>Customize your channel settings.</p>
	<p>Set rating limits on your TV based on program rating or content.</p>

Menu

Allows you to

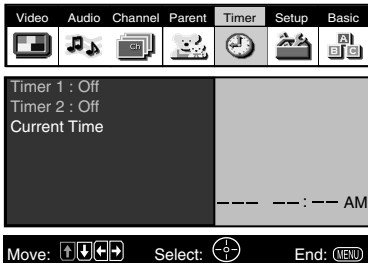

Set the clock on your TV and program scheduled viewing using Timer 1 and Timer 2.



Select closed captioning options, label video inputs, adjust tilt correction, enhance your picture resolution for your DVD (16:9 Enhanced), select menu language, or run a demo of the menus.

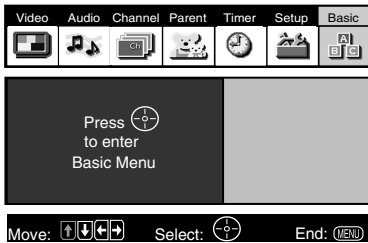

Set the menus to display a simplified menu of most commonly-used menu settings.

Using Picture in Picture (PIP) with Remote Y181

The Picture-in-Picture (PIP) feature allows you to view two programs simultaneously, one in the full size “main” picture and one in a small “window” picture.

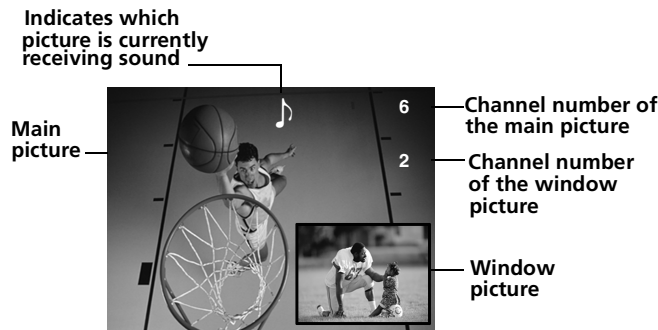

Displaying Picture in Picture



To use PIP

- 1** Press the TV button in the FUNCTION bar to control PIP with the yellow-labeled buttons. Tune your TV to a channel which you know is currently airing programming.
- 2** Press the  button to display the window picture.
- 3** Use the PIP (yellow) CH +/- buttons to change the channel in the PIP window picture.









To check your PIP

- 1** Press the TV button in the FUNCTION bar to control PIP with the yellow-labeled buttons. Tune your TV to a channel which you know is currently airing programming.
- 2** Press the  to turn PIP on. Press , the channel from the main window should now appear in the window picture.
- 3** Select the same channel in the main picture (use the CH+/- buttons on the bottom of your remote control). You should now have the same program playing in both windows.
- 4** Use the PIP (yellow) CH+/- buttons to change the channel in the PIP window picture.
- 5** Press the  PIP (yellow) button to switch the PIP window to other video inputs for other equipment that is connected to any of the VIDEO IN jacks of your TV. You should see a different picture in your PIP window for each piece of connected video equipment. Make sure the connected equipment is turned on and working when you perform this test.
- 6** If the PIP feature does not work properly with the TV or the connected video equipment, refer to the troubleshooting section beginning on page 52.

 If you're having problems with PIP, refer to "Setups that Affect Your Ability to Use PIP" (page 28) or see Troubleshooting section (page 52) for possible solutions.

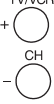
PIP Functions buttons

For KV-27FV300 model

Yellow labeled PIP button	Description
	Press to turn the PIP feature on and off. Press repeatedly to change the window size (1/9, 1/16, Off).
	Press to cycle through the available video equipment you have connected to the TV (in the PIP window picture).
	Press to alternate sound between the main picture and the PIP window picture. The sound symbol  appears for three seconds, indicating whether you are hearing the sound from the main or PIP window picture.
	Press to change the channel in the PIP window picture. To change the channel in the main window, use the main CH+/- buttons at the bottom of the remote control.
	Press to move the location of the window picture to any of the four corners of the screen.
	Press to freeze the window picture. Press again to restore the picture. The main window continues to play as usual.
	Press to switch the main picture with the PIP window picture. Press again to switch back.

 For more information about your remote control, see "Using the Remote Controls" on page 3.

To change channels/programs in the PIP window

- Use the yellow PIP CH+/- button to scroll through TV channels.
- Use the yellow TV/VIDEO button to cycle through your other video equipment connected to the TV, such as your VCR, DVD player, or satellite receiver.

Using Picture in Picture (PIP) with Remote Y182

The Picture-in-Picture (PIP) feature allows you to view two programs simultaneously, one in the full size “main” picture and one in a small “window” picture.

Displaying Picture in Picture

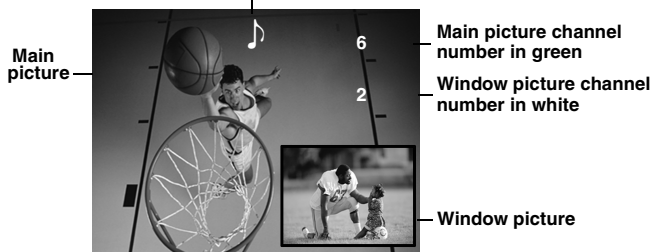

Indicates which picture is currently receiving sound



To use PIP

- 1** Press the TV button in the FUNCTION bar to control PIP with the yellow-labeled buttons. Tune your TV to a channel which you know is currently airing programming.
- 2** Press the  button to display the window picture.
- 3** Use the PIP (yellow) CH+/- buttons to change the channel in the PIP window picture.

To check your PIP





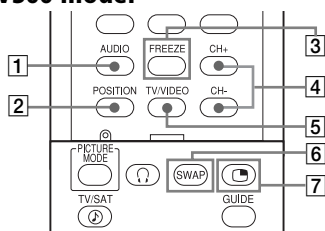

- 1** Press the TV button in the FUNCTION bar to control PIP with the yellow-labeled buttons. Tune your TV to a channel which you know is currently airing programming.
- 2** Press the  to turn PIP on. Press , the channel from the main window should now appear in the window picture.
- 3** Select the same channel in the main picture (use the CH+/- buttons on the bottom of your remote control). You should now have the same program playing in both windows.
- 4** Use the PIP (yellow) CH+/- buttons to change the channel in the PIP window picture.
- 5** Press the  PIP (yellow) button to switch the PIP window to other video inputs for other equipment that is connected to any of the VIDEO IN jacks of your TV. You should see a different picture in your PIP window for each piece of connected video equipment. Make sure the connected equipment is turned on and working when you perform this test.
- 6** If the PIP feature does not work properly with the TV or the connected video equipment, refer to the troubleshooting section beginning on page 52.

 If you're having problems with PIP, refer to "Setups that Affect Your Ability to Use PIP" (page 28) or see Troubleshooting section (page 52) for possible solutions.

PIP Functions buttons

For KV-32FV300, KV-36FV300 model



Yellow-labeled PIP Button	Description
1 AUDIO 	Press to alternate sound between the main picture and the PIP window picture. The sound symbol (♪) appears for 3 seconds, indicating whether you are hearing sound from the main picture or the PIP window picture.
2 POSITION 	Press to move the location of the window picture to any of the four corners of the screen.
3 FREEZE 	Press to freeze the window picture. Press again to restore the window picture. The main window continues to play as usual.
4 CH+ CH- 	Press to change the channel in the PIP window picture. To change the channel in the main window, use the main CH+/- buttons at the bottom of the remote control.
5 TV/VIDEO 	Press to cycle through the available video equipment you have connected to the TV (in the PIP window picture).
6 SWAP 	Press to switch the main picture with the PIP window picture. Press again to switch back.
7 	Press to turn the PIP feature on and off. Press repeatedly to change the window size (1/9, 1/16, Off).

 For more information about your remote control, see “Using the Remote Controls” on page 3.

To change channels/programs in the PIP window

- Use the yellow PIP CH+/- button to scroll through TV channels.
- Use the yellow TV/VIDEO button to cycle through your other video equipment connected to the TV, such as your VCR, DVD player, or satellite receiver.

Setups that Affect Your Ability to Use PIP

- ❑ Any video equipment you have connected to the AUX input cannot be viewed in the PIP window.
- ❑ If you are viewing all channels through a cable box, the PIP feature will not work. The cable box only unscrambles one signal at a time, so the window picture will be the same as the main picture.
- ❑ You can use PIP to see pictures from different sources on your TV. For example, you can have a regular (CATV) channel and the output from a VCR, DVD player or satellite receiver on screen at the same time using PIP. To do this:
 - 1** Connect the CATV cable to the VHF/UHF input on the back of the TV.
 - 2** Connect the peripheral (VCR, DVD player or satellite receiver) to any of the VIDEO IN inputs on the the back of the TV.
 - 3** Tune to one image in the main picture.
 - 4** Tune to a second image in the PIP window.You can then SWAP the images on the TV screen.

 You cannot use a signal from the AUX input with PIP.

Using Wireless Headphones

 Wireless headphones are included and can be used only with Sony TV models KV-32FV300 and KV36FV300.

Installing the Battery

Install the supplied size AA (R6) battery into the headphones.

- 1 Open the battery compartment lid by pressing and sliding the lid as illustrated.

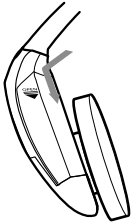

- 2 Insert the battery into the compartment with the positive side up and then close the lid.

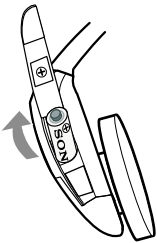



When used continuously, the battery lasts:

- up to 40 hours with an alkaline battery
- up to 20 hours with a manganese battery

Replace the battery with a new one when the sound becomes weak.

Using the Headphones

1 Press . (The  icon and channel number display.)



2 Place the headphones securely onto your head.

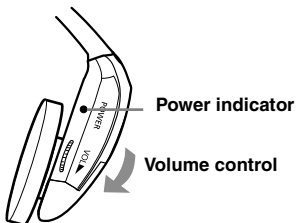

To listen to sound only from wireless headphones

- Turn down the TV speaker level, or press MUTING on the remote control.

To turn off headphones

- Put down the headphones and press .

To ensure optimal sound reception with headphones

- Be sure that the infrared transmitter on the TV and the infrared sensors on the headphones have a clear (unobstructed) line of sight to one another.

To protect the TV's infrared transmitter from possible damage

- Press  to turn off the headphone feature when the headphones are not in use.

To protect your hearing from sudden or prolonged excessive volume

- Set the headphone volume just high enough to hear comfortably.

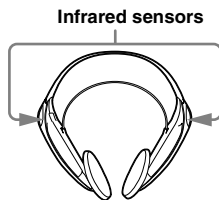
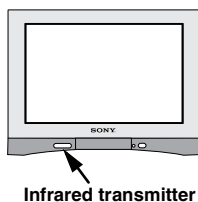

 For optimal sound quality, be sure that the infrared transmitter on the TV and the infrared sensors on the headphones are not obstructed and can "see" one another.



Listening to Sound from Main and PIP Window Pictures

To use your headphones to listen to the sound from the main or window picture (when using PIP), select the audio source.

- 1 If PIP is not displayed, press  to display a PIP window.



- 2 Press .

The  icon and channel number appear for about three seconds. The  is level with the channel number of the main picture.



Main picture audio

Press  again to switch the audio to the PIP window.

The  icon changes, dropping down to the level of the PIP channel.



Window picture audio

- 3 When you are finished using the headphones, press  to turn them off.





Headphones off

 When you exit PIP, the sound will return to the main picture. SAP (Second Audio Program) are not available in the PIP Window. The audio to the headphones automatically turns off when you turn off the TV.



Using the Menus

This section shows the options available for setting up and adjusting the TV.







Depending on the model of television that you have purchased, your remote control will have either a joystick (RM-Y182), or directional buttons (⬆ ⬇ ⬅ ➡) and a  button (RM-Y181).



 The directions in this manual will refer to the remote control that incorporates a joystick (RM-Y182). See "Using the Remote Control" on page 3 for further details of this remote.

How to access menus with Remote Control Y182

- 1 Press  to display the on-screen menu.
- 2 Use the joystick to highlight the desired menu icon. Press  to select it.
- 3 Use the joystick to scroll up and down through the features.
- 4 Follow the instructions on the screen.
- 5 See the specific menu page for instructions on moving through the menu.
- 6 Press  to exit the menu.

How to access menus with Remote Control Y181

- 1 Press  to display the on-screen menu.
- 2 Use the  or  buttons to highlight the desired menu icon. Press  to select it.
- 3 Use the  or  buttons to scroll up and down through the features.
- 4 Follow the instructions on the screen.
- 5 See the specific menu page for instructions on moving through the menu.
- 6 Press  to exit the menu.

 Depending on the model, press  once to display the on-screen menu, and press again to return to normal viewing. If no buttons are pressed, the menu closes automatically after about 90 seconds.

Using the Video Menu



To access the Video menu, refer to the following steps using the joystick of your remote control:

To Display



To Select



Press joystick  to highlight an option then press .

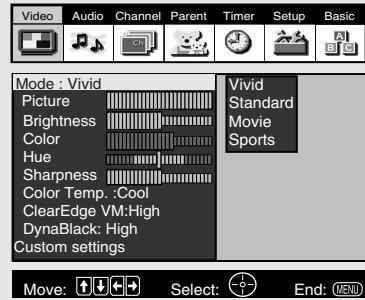

Mode

Customized picture viewing

Use the joystick to scroll up or down to select from one of the following options, then press  to select it.

- Vivid:** Select for enhanced picture contrast and sharpness.
- Standard:** Select for a standard picture.
- Movie:** Select for a finely detailed picture.
- Sports:** Select for a bright picture.



Press  button on the remote control for direct access to the Picture Modes (Vivid, Standard, Movie, Sports).

Picture Controls

- Picture:** Press the joystick left to decrease the contrast.
Press the joystick right to increase the contrast.
- Brightness:** Press the joystick left to darken the picture.
Press the joystick right to brighten the picture.
- Color:** Press the joystick left to decrease the color saturation.
Press the joystick right to increase the color saturation.
- Hue:** Press the joystick left to increase the red tones.
Press the joystick right to increase the green tones.
- Sharpness:** Press the joystick left to soften the picture.
Press the joystick right to sharpen the picture.

Color Temp.

White tint adjustment

Use the joystick to scroll up or down to select from one of the following options, then press  to select it.

- Cool:** Gives white colors a blue tint.
- Neutral:** Gives white colors a neutral tint.
- Warm:** Gives white colors a red tint.

ClearEdge VM

Sharpens picture definition to give objects a sharp, clean edge. Use the joystick to scroll up or down to select from one of the following options: **Off, High, Low**, then press .



DynaBlack

Improves contrast and sharpens image detail. Use the joystick to scroll up or down to select from one of the following options: **Off, High, Low**, then press .



Using the Audio Menu



To access the Audio menu, refer to the following steps:



Press joystick  to highlight an option then press .



Treble	Press the joystick left to decrease higher pitched sound. Press the joystick right to increase higher pitched sound.
Bass	Press the joystick left to decrease lower pitched sound. Press the joystick right to increase lower pitched sound.
Balance	Press the joystick left to emphasize the left speaker. Press the joystick right to emphasize the right speaker.
Steady Sound <i>Stabilizes volume</i>	Use the joystick to scroll up or down to select from one of the following options, then press  to select it. On: Select to stabilize the volume when changing channels. Off: Select to turn Steady Sound Off.
Effect	Use the joystick to scroll up or down to select from one of the following options, then press  to select it. Simulated: Simulates theater quality sound for mono programs. WOW: Provides a dramatic presence with a full, deep bass sound. When WOW is enabled, BBE is directly activated to further enhance the audio performance. TruSurround: Produces a dynamic three dimensional sound for stereo audio signals. Off: Normal stereo or mono reception.

 Press  for direct selection of Effect settings (Simulated, WOW, TruSurround, Off).

MTS

*Multi-Channel
TV Sound*

Use the joystick to scroll up or down to select from one of the following options, then press  to select it.

Stereo: Select when viewing a broadcast in stereo.

Auto SAP: Select to have the TV automatically switch to a Second Audio Program (SAP) when a signal is received.

Mono: Select to reduce noise in areas of poor reception.



Press



button on the remote control for direct access to the MTS settings (Stereo, Auto SAP, Mono).

Speaker

*Custom
selection of
audio output
source*

Use the joystick to scroll up or down to select from one of the following options, then press  to select it.

On: Select to listen to the sound from the TV speakers with or without a separate stereo system.

Off: Select to turn off the TV speakers and listen to the TV's sound only through external audio system speakers.

Audio Out

*Use to control
the TV's volume
through a stereo*

Use the joystick to scroll up or down to select from one of the following options, then press  to select it.

Audio Out settings can only be set when speakers are set to Off.

Variable: Adjust the volume through your TV.

Fixed: Adjust the TV volume through a connected stereo.



Audio Out settings can only be set when Speaker is set to Off.





If your TV is set to Auto SAP, some programs may be muted or distorted. If your TV does not output sound, change your Audio MTS setting to Stereo or Mono.

Using the Channel Setup Menu

To access the Channel Setup menu, refer to the following steps:

To Display → **To Highlight** → **To Select**







Press joystick  to highlight an option then press .



Favorite Channels

Quick access to favorite channels

Press  to open the Favorite Channels menu:

- 1 Use the joystick to scroll up or down to select the position (1-8) where you want to set a favorite channel, then press .
- 2 Use the joystick to scroll through the channels until you find the channel you want to add to your favorite channels.
- 3 Press  to select it, that will change your TV automatically to the selected channel.
- 4 Press the joystick left to return to the channel setup menu or press  to exit.

 To use Favorite Channels: Exit all menus and press . Press  or  to move the cursor to the desired channel number and press .

Cable

Use the joystick to scroll up or down to select from one of the following options, then press  to select it.





- On:** Select if you are receiving cable channels with a CATV cable.
Off: Select if you are using a TV antenna.



 After changing your cable settings, you will need to perform Auto Program.







Channel Fix

Use the joystick to scroll up or down to select from one of the following options, then press  to select it.

- 2-6:** Select when you want to control all channel selection through a cable box or VCR. Select the appropriate channel (usually 3 or 4) and use the cable box's or VCR's remote control for channel selection.
- Video 1:** Select from available video inputs when you have connected video equipment (e.g. satellite receiver) and you want your TV fixed to it.
- AUX 2-6:** Use this setting instead of the **2-6** if you want to change channels using a cable box, VCR or satellite receiver and you've connected it to the AUX input.
- Off:** Channel Fix is not set.

Auto Program	Perform Auto Program whenever setting up your TV. Auto program will search for available channels and program receivable channels.
Channel Skip/Add	Use this feature after you run Auto Program to skip unwanted channels or add new ones. Press  to open Channel Skip/Add menu: <ol style="list-style-type: none">1 Use the joystick to scroll up and down to select the position of the desired channel, then press .2 Use the joystick to scroll up and down to select Skip/Add, then press .3 Press the joystick left to return to the channel setup menu or press  to exit.

 Pressing CH+ or CH- will skip over channels that have been skipped. You can still use the  buttons to directly tune to skipped channels.

Channel Label <i>Label up to 40 channels with their call letters</i>	Press  to open the Channel Label menu: <ol style="list-style-type: none">1 Press , then use the joystick to scroll through the channels until you reach the desired channel number.2 Press  to activate the channel.3 Scroll down to highlight "Label", then press . Use the joystick to scroll up or down to display the first call letter or number of the caption. Press  to select. Repeat this process until you finish selecting all the call letters.4 When finished, press  to activate.5 Press the joystick left to return to the channel setup menu or press  to exit.
--	--

 You cannot use Favorite Channels, Cable, Channel Skip/Add, and Channel Label when Channel Fix is set.

Using the Parent Menu

To access the Parent menu, refer to the following steps:

To Display **To Highlight**  **To Select**

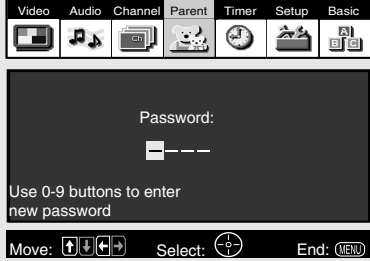



The Parental Control feature is designed to help parents monitor what their children watch on television.

To use the Parent Menu

In Parent menu, you will be asked to set a 4-digit password for any further access into Parent menu.

- 1** Use the ①-⑨ buttons to enter a 4-digit password.
- 2** Confirm your password by entering it again.

 Keep this manual in a safe place. You need your password for any future access to the Parental Control menu. If you forget your password, see page 54.

Once your password is set correctly, the Parent menu appears.

Parental Control

Setting the Rating

You can change the Rating by selecting one of the Parental Lock options.



- 1 Use the joystick to highlight Parental Lock, press **[+]**.

If you are not familiar with Parental Guideline rating system, use one of the following preset categories to simplify the rating selection: Child, Youth, Young Adult.

- 2 Use the joystick to scroll up or down to select the desired rating and press **[+]**.

Rating	TV will allow a maximum rating of
Child	TV-Y, TV-G, G (U.S.), G, C (Canada)
Youth	TV-PG, PG (U.S.), 8 ans + (Canada)
Young Adult	TV-14, PG-13 (U.S.), 14+ (Canada)
Custom	Select to set more restrictive ratings (see next section)
Off	No rating limit

Changing your Password

- 1 Use the joystick to scroll up or down to move the cursor to Change Password and press **[+]**.
- 2 Follow steps 1 and 2 for “Using the Parent Menu” on page 39.

Select a Country

Select U.S.A. to use US ratings (see pages 42-43) or select Canada to use Canadian ratings (see page 44). If you select a Country (U.S.A. or Canada) that is not where you live, the rating you select will not be activated.

- 1 Use the joystick to highlight Parental Lock, press **[+]**.
- 2 Use the joystick to scroll up or down to select the desired country and press **[+]**.

Information for Parents

To view a program that exceeds the TV rating

- Press , then use the - buttons to enter your password.

 Entering your password to view a blocked program will temporarily turn Lock to Off. To reactivate your Lock settings, turn the TV off then back on; the TV will return to the settings that you have selected.

Using the Custom Menu

Follow the instructions on the screen to make your custom settings. Select the country desired for your TV's rating limit. See page 42 for U.S. models and page 44 for Canadian models for more information.

 Once you have blocked a rating or content, all higher ratings or content will be automatically blocked.

United States: Selecting Custom Rating Options

For the United States, the Custom Rating Menu includes the following options: Movie Rating, TV Rating and Unrated. (For Canada, see page 44.)

Movie Rating

This system defines the rating levels of movies shown in theaters and on prime cable channels.

Rating	Defined as
G	General audience
PG	Parental Guidance suggested
PG-13	Parents strongly cautioned
R	Restricted
NC-17	No one 17 and under admitted
X	Adult audience only



TV Rating

The TV rating is divided into two groups: age-based and content-based.

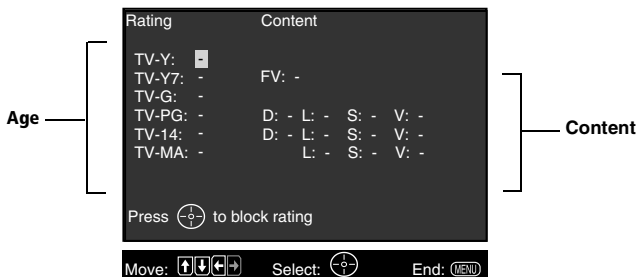

Age	Defined as
TV-Y	All children
TV-Y7	Directed to older children
TV-G	General audience
TV-PG	Parental Guidance suggested
TV-14	Parents strongly cautioned
TV-MA	Mature Audience only

Content	Defined as
FV	Fantasy Violence
D	Suggestive dialogue
L	Strong language
S	Sexual situations
V	Violence

The content ratings will increase depending on the level of the age-based rating. For example, a program with a TV-PG V (Violence) rating may contain moderate violence, while a TV-14 V (Violence) rating may contain intense violence.

Unrated

You have the option of blocking TV programs or movies that are not rated.

Allow	Allows all unrated programs
Block	Blocks all unrated programs



 If you choose to block unrated TV programs, please be aware that the following programs may be blocked: emergency broadcasts, political programs, sports, news, public service announcements, religious programs and weather.

Canada: Selecting Custom Rating Options

For Canada, the Custom Rating Menu includes the following options: English Rating, French Rating and U.S.A. Rating.

English Rating

These ratings are for Canadian programs that are broadcast in English.

Rating	Defined as
C	Children
C8+	Children 8 years and older
G	General programming
PG	Parental Guidance
14+	Viewers 14 and older
18+	Adult programming

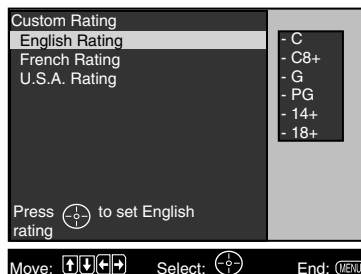

French Rating

These ratings are for Canadian programs that are broadcast in French.

Rating	Defined as
G	General
8 ans+	Not recommended for younger children
13 ans+	Not recommended for children under age 13
16 ans+	Not recommended for ages under 16
18 ans+	This program is restricted to adults







U.S.A. Rating

For programs from the United States, please see "TV Rating" on page 42.

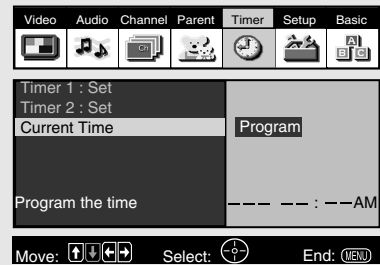
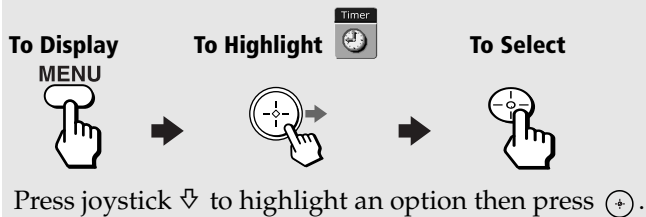



Using the Timer Menu

To access the Timer menu, refer to the following steps:



- Current Time** Set your TV to the current day and time.
- 1 Use the joystick to scroll up or down to enter the correct day and time, then press .
 - 2 Press  to return Timer menu or press  to exit the menu.

 You must set the Current Time before you can use Timer 1 or Timer 2.

- Timer 1 and Timer 2**
Scheduled viewing
- Use the timers to program your TV to turn on and off by day, time, duration and channel. The timers duration is maximum of 6 hours. When the channel is fixed, it is not necessary to set the channel. Press  to program Timer 1 or Timer 2.
- 1 Use the joystick to highlight to select Timer 1 or Timer 2, then press .
 - 2 Use the joystick to enter the desired day, start time, duration, and channel, then press . The timer status should be On when the Timer has been set, and the Timer light on the front panel of the TV should be turned on.
 - 3 Press  to exit the menu.

 Select Off to turn off the Timer (your previous settings will be saved).

 When you perform Auto Program, Timer 1 and Timer 2 settings will be cleared. Also, in the event of any loss of power, Current Time, Timer 1 and Timer 2 settings will be cleared.

Using the Setup Menu



To access the Setup menu, refer to the following steps:

To Display



To Highlight



To Select



Press joystick to highlight an option then press .



Caption Vision

Closed-captioning

Allows you to select from three closed caption modes (for programs that are broadcast with closed captioning).

Use the joystick to scroll up or down to select from one of the following options, then press .

CC1, 2, 3, 4: Displays printed dialogue and sound effects of a program.

Text1, 2, 3, 4: Displays network/station information.

Info: Displays the name of the current program and its remaining time, if available.

Off: Caption Vision is not activated.

Video Label

Label connected equipment

Allows you to identify the audio/video components connected to the TV: VCR, DVD, etc. When you press TV/VIDEO to switch inputs, the Video Label will display on-screen. Press to open the Video Label menu:

1 Use the joystick to scroll up or down to select the video input you want to label and press .

2 Use the joystick to choose a label and press .

If you select "Skip", your TV skips this connection when you press the TV/VIDEO button.

Tilt Correction

Use the joystick to scroll up or down to correct any tilt of the picture from -5 to +5, then press to activate.

Language

Display all menus in the language of your choice. Use the joystick to scroll up or down to select from one of the following options: English, Español (Spanish) and Français (French). Then press .

16:9 Enhanced

Provides enhanced picture resolution for wide-screen sources such as DVD (only available when the TV is in Video mode).

Demo

Press to run a demonstration of the on-screen menus.



You can press any key to exit Demo mode.

Using the Basic Menu



To access the Basic menu, refer to the following steps:



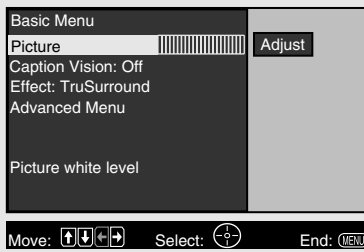

To Display → **To Highlight** → **To Select**



Press joystick  to highlight an option then press .









Picture	Use joystick left to decrease picture contrast.
<i>Picture contrast</i>	Use joystick right to increase picture contrast.
Caption Vision	In the Basic menu, Caption Vision options are Off and the last captioning option selected (CC1-4, Text 1-4, or Info).
<i>Closed-Captioning</i>	
Effect	Use the joystick to scroll up or down to select one of the following options, then press  to select it.
Simulated:	Simulates theater quality sound for mono programs.
WOW:	Provides a dramatic presence with a full, deep bass sound. When WOW is enabled, BBE is directly activated to further enhance the audio performance.
TruSurround:	Produces a dynamic three dimensional sound for stereo audio signals.
Off:	Normal stereo or mono reception.
Advanced Menu	Press  to return to the advanced menus.

 If you use the  button to close the Basic menu, only the Basic menu appears when you press  again. To access the other menus, use the joystick to scroll down to highlight Advanced Menu, then press .

Other Information

Programming the Remote Control

You can use the supplied remote control to operate Sony or non-Sony video equipment.

- 1 Press .
- 2 Press  or  (FUNCTION).
- 3 Use the - buttons to key in the code number from the following chart.
- 4 Press .

VCR codes

Sony	301, 302, 303	JCPenney	309, 305, 304, 330, 314, 336, 337
Admiral (M.Ward)	327	JVC	314, 336, 337, 345, 346, 347
Aiwa	338, 344	Kenwood	314, 336, 332, 337
Audio Dynamic	314, 337	LXI (Sears)	332, 305, 330, 335, 338
Broksonic	319, 317	Magnavox	308, 309, 310
Canon	309, 308	Marantz	314, 336, 337
Citizen	332	Marta	332
Craig	302, 332	Memorex	309, 335
Criterion	315	Minolta	305, 304
Curtis Mathis	304, 338, 309	Mitsubishi/MGA	323, 324, 325, 326
Daewoo	341, 312, 309	Multitech	325, 338, 321
DBX	314, 336, 337	NEC	314, 336, 337
Dimensia	304	Olympic	309, 308
Emerson	319, 320, 316, 317, 318, 341	Optimus	327
Fisher	330, 335	Panasonic	308, 309, 306, 307
Funai	338	Pentax	305, 304
General Electric	329, 304, 309	Philco	308, 309
Go Video	322, 339, 340	Philips	308, 309, 310
Goldstar	332	Pioneer	308
Hitachi	306, 304, 305, 338	Quasar	308, 309, 306
Instant Replay	309, 308	RCA/PROSCAN	304, 305, 308, 309, 311, 312, 313, 310, 329
Realistic	309, 330, 328, 335, 324, 338	Symphonic	338
Samsung	322, 313, 321	Tashiro	332
Sansui	314	Tatung	314, 336, 337
Sanyo	330, 335	Teac	314, 336, 338, 337

VCR codes

Scott	312, 313, 321, 335, 323, 324, 325, 326	Technics	309, 308
Sharp	327, 328	Toshiba	312, 311
Shintom	315	Wards	327, 328, 335, 331, 332
Signature 2000 (M.Ward)	338, 327	Yamaha	314, 330, 336, 337
SV2000	338	Zenith	331
Sylvania	308, 309, 338, 310		

Cable box codes

Sony	230
Hamlin/Regal	222, 223, 224, 225, 226
Jerrold/G. I.	201, 202, 203, 204, 205, 206, 207, 208, 218
Oak	227, 228, 229
Panasonic	219, 220, 221
Pioneer	214, 215
Scientific Atlanta	209, 210, 211
Tocom	216, 217
Zenith	212, 213

Laser Disc Player codes

Sony	701
Panasonic	704, 710
Pioneer	702

DBS codes

DIRECTV	809
Echostar/Dish Network	810

Satellite receiver codes

Sony	801
General Electric	802
Hitachi	805
Hughes	804
Panasonic	803
RCA/PROSCAN	802, 808
Toshiba	806, 807

DVD Player codes









Sony	751
JVC	756
Mitsubishi	761
Onkyo	762
Oritron	759
Panasonic	753
Philips/ Magnavox	757
Pioneer	752
RCA	755
Samsung/Hitachi	758
Toshiba	754
Zenith	760

 If more than one code number is listed, try entering them one by one until you come to the correct code for your equipment.



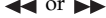





 Whenever you remove the batteries, the code numbers may revert to the factory setting and must be reset.

 In some rare cases, you may not be able to operate your equipment with the supplied remote control. In this case, use the equipment's supplied remote control.



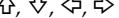

Operating a VCR

Press	To
	Power on the VCR
	Select channels directly
	Change channels
	Play video tape
	Stop
	Search forward or backward
	Pause
	Record
	Change between VCR and TV inputs

Operating a DVD

Press	To
	Power on the DVD
	Select chapters directly
	Search chapters forward or backward
	Play DVD
	Stop
	Pause
	Move the cursor in the menu
	Display the DVD menu



Operating a Laser Disc

Press	To
	Power on the laser disc
	Search chapters forward or backward
	Play disc
	Stop
	Pause

Troubleshooting

If you are having a problem with your TV, try the suggestions below. If the problem persists, contact your nearest Sony Dealer.

Problem	Possible Solutions
Reset the TV to factory settings	<ul style="list-style-type: none"> ❑ Turn on the TV. While holding down the RESET button on the remote control, press POWER button on the TV front panel. (The TV will turn itself off, then back on again.) Release the RESET button.
No picture, no sound	<ul style="list-style-type: none"> ❑ Make sure the power cord is plugged in. ❑ If a red light is flashing on the front of your TV for more than a few minutes, disconnect and reconnect the power cord to restore the TV. If the problem continues, call your local service center. ❑ Check the TV/VIDEO setting: when watching TV, set to TV; when watching video equipment, set to VIDEO 1, 2, 3 or 4 (page 4, 6). ❑ Make sure the batteries have been inserted correctly into the remote control (page 2). ❑ Try another channel to rule out station trouble.
Poor or no picture, good sound	<ul style="list-style-type: none"> ❑ Adjust the Picture setting in the Video menu (page 34). ❑ Adjust the Brightness setting in the Video menu (page 34). ❑ Check the antenna and/or cable connections (page 10).
Good picture, no sound	<ul style="list-style-type: none"> ❑ Press  so that Muting disappears from the screen (page 3 for remote Y181, page 5 for remote Y182). ❑ Check your Audio settings. Your TV may be set to Auto SAP in the MTS feature (page 36).
No color	<ul style="list-style-type: none"> ❑ Adjust the Color setting in the Video menu (page 34).
Only snow appears on the screen	<ul style="list-style-type: none"> ❑ Check the Cable setting in the Channel Setup menu (page 37). ❑ Check the antenna and/or cable connections (page 10). ❑ Make sure the channel selected is currently broadcasting.
Dotted lines or stripes	<ul style="list-style-type: none"> ❑ Adjust the antenna. ❑ Move the TV away from other electronic equipment. Some electronic equipment creates electrical noise, which can interfere with TV reception.
Double images or ghosts	<ul style="list-style-type: none"> ❑ Check your outdoor antenna or call your cable service.
Cannot receive higher number channels (UHF) when using an antenna	<ul style="list-style-type: none"> ❑ Make sure Cable is set to Off in the Channel Setup menu (page 37). ❑ Perform Auto Program to add channels that are not presently in the memory (page 21).

Problem	Possible Solutions
Cable stations don't seem to work	<ul style="list-style-type: none"> ❑ Make sure Cable is set to On in the Channel Setup menu (page 37). ❑ Perform Auto Program to add channels that are not presently in the memory (page 21).
Remote control does not operate	<ul style="list-style-type: none"> ❑ Press TV (FUNCTION) when operating your TV. ❑ Check the orientation of the batteries. ❑ Batteries could be weak. Replace them (page 2). ❑ Move the TV three to four feet away from fluorescent lights.
Cannot change channels with the remote control	<ul style="list-style-type: none"> ❑ Make sure you have not inadvertently switched your TV from the channel 3 or 4 setting if you are using another device to change channels. ❑ If you are using another device to control channels, be sure that you have pressed the FUNCTION button for that device. For example, if you're using your VCR to control channels, be sure to press the VCR/DVD FUNCTION buttons (page 3 for remote Y181, page 5 for remote Y182).
Cannot access other menus when using the Basic menu	<ul style="list-style-type: none"> ❑ If you use the  button to close the Basic menu, only the Basic menu appears when you press  again. To access the other menus, select the Advanced Menu option (page 47).
The remote control doesn't work in PIP mode	<ul style="list-style-type: none"> ❑ Press the TV FUNCTION button. You may have inadvertently pressed the VCR/DVD FUNCTION button, which changes the PIP buttons to VCR mode (page 24 for remote Y181, page 26 for remote Y182).
There is no window picture or it is just static	<ul style="list-style-type: none"> ❑ Be sure your PIP window picture is set to a video source/channel that has a program airing. ❑ You may be tuned to a video input with nothing connected to it. Try cycling through your video inputs using the yellow PIP TV/VIDEO button with the red dot (page 26 for remote Y182, page 24 for remote Y181).
I get the same program in the window picture as in the main picture	<ul style="list-style-type: none"> ❑ Both may be set to the same channel. Try changing channels in either the main picture or the window picture (page 26 for remote Y182, page 24 for remote Y181). ❑ Your TV may be set up to select all your channels through a cable box. The cable box will only unscramble one signal at a time, so you cannot use the PIP feature. If possible, run a direct cable to the VHF/UHF jack on your TV. This will only work if your cable system provides an unscrambled signal (page 12).

Problem	Possible Solutions
I cannot get anything but TV	<input type="checkbox"/> Be sure that you did not set the video label in the Setup menu (page 46) to skip your video inputs. If a video input is skipped, the problem will happen both in the main and PIP pictures.
The TV needs to be cleaned	<input type="checkbox"/> Clean the TV with a soft dry cloth. Never use strong solvents such as thinner or benzine, which might damage the finish of the cabinet.
Lost password for Parental Control	<input type="checkbox"/> In the password screen, enter the following master password: 4357. After using the master password, you must create a new password, it cannot be used to unlock currently blocked channels.
You lost your remote control	<input type="checkbox"/> You can use the front panel controls to access your menus, change channels, adjust the volume or change video inputs (page 2). Contact your nearest Sony Dealer to order a replacement, please call our Sony Direct Accessory and Part Center at 1-800-488-7669 (U.S. residents only).
There is a black box on the screen	<input type="checkbox"/> You have selected a text option in the Setup menu (page 46) and no text is available. To turn off this feature, select Off in the Caption Vision option. If you were trying to select closed captioning, select CC1 instead of Text 1-4.
TV doesn't turn on after disconnecting the TV and timer LED flashes	<input type="checkbox"/> Press the POWER button on your remote control or in the TV front panel, one more time.

If, after reading these Operating Instructions, you have additional questions related to the use of your Sony television, please call our Customer Information Services Center at 1-800-222-SONY (7669) (U.S. residents only) or (416) 499-SONY (7669) (Canadian residents only).

Specifications

For all models (except as noted)

Television system	American TV standard/NTSC (KV-27FV300, KV-32FV300, KV-36FV300)
Channel coverage	VHF: 2-13/UHF: 14-69/CATV: 1-125
Antenna	75-ohm external antenna terminal for VHF/UHF
Picture tube	FD Trinitron® tube
Power requirements	120V, 60 Hz (KV-27FV300, KV-32FV300, KV-36FV300)
Supplied Accessories	Size AA (R6) batteries (2) Remote Control RM-Y181 (1) (KV-27FV300) Remote Control RM-Y182 (1) (KV-32FV300 and KV-36FV300) Wireless Headphones (1) (KV-32FV300 and KV-36FV300)
Optional Accessories	TV Stand: SU-27HV1 for KV-27FV300, SU-32HV1 for KV-32 FV300 SU-36HV1 for KV-36FV300

KV-27FV300

Screen size	Visible screen size: 679 mm (27 inches) measured diagonally Actual screen size: 736,6 mm (29 inches) measured diagonally
Inputs/outputs	Inputs 3 video, 3 audio Outputs 2 S VIDEO 1 AUDIO OUT 2 RF Inputs 1 MONITOR OUT 1 Y, Pb,Pr, 1 audio
Speaker output	7.5 W x 2, 15 W subwoofer
Power Consumption	220 W in use 1 W in standby
Dimensions (W/H/D)	784 x 601.5 x 520 mm (30 ⁷ / ₈ x 23 ¹¹ / ₁₆ x 20 ¹ / ₂ inches)
Mass	48 kg (105 lbs. 13 oz.)

KV-32FV300

Screen size	Visible screen size: 803 mm (32 inches) measured diagonally Actual screen size: 863,6 mm (34 inches) measured diagonally
Inputs/outputs	Inputs 3 video, 3 audio Outputs 2 S VIDEO 1 AUDIO OUT 2 RF Inputs 1 MONITOR OUT 1 Y, Pb,Pr, 1 audio
Speaker output	7.5 W x 2, 15 W subwoofer
Power Consumption	230 W in use 1 W in standby
Dimensions (W/H/D)	898 x 682 x 584 mm (35 ³ / ₈ x 26 ⁷ / ₈ x 23 inches)
Mass	78 kg (171 lbs. 15oz.)

KV-36FV300

Screen size	Visible screen size: 911 mm (36 inches) measured diagonally Actual screen size: 965.2 mm (38 inches) measured diagonally
Inputs/outputs	Inputs 3 video, 3 audio Outputs 2 S VIDEO 1 AUDIO OUT 2 RF Inputs 1 MONITOR OUT 1 Y, Pb,Pr, 1 audio
Speaker output	7.5 W x 2, 15 W subwoofer
Power Consumption	230 W in use 1 W in standby
Dimensions (W/H/D)	1020 x 760 x 640 mm (40 ¹ / ₄ x 30 x 25 ¹ / ₄ inches)
Mass	102 kg (224 lbs. 14oz.)

Design and specifications are subject to change without notice.

Index

16:9 Enhanced **46**

A

Audio Out **36**
Auto Program **21, 33**
Auto SAP **36**

B

Balance **35**
Bass **35**
Batteries
 Inserting in remote **2**
 Inserting in wireless headphones **29**
Brightness **34**

C

Cable **37**
Caption Vision **46**
Channel Fix **37**
Channel Label **38**
Channel Skip/Add **38**
ClearEdge VM **34**
Color **34**
Color Temperature **34**
Connections
 Cable and antenna **10**
 Cable Box and Cable **11**
 Connecting a Camcorder **19**
 Connecting a DVD Player **18**
 Connecting an Audio System **19**
 Connecting Two VCRs **15**
 TV and Cable Box **11**
 TV and Satellite Receiver **16**
 TV and VCR **13**
 TV, Satellite Receiver and VCR **17**
 TV, VCR and Cable Box **14**
Current Time **45**

D

Demo **46**
DISPLAY
 RM-Y-181 **3**
 RM-Y182 **5**
DynaBlack **34**

E

Effect
 Off **35**
 Simulated **35**
 TruSurround **35**
 WOW **35**

F

Favorite Channels **37**

H

Hue **34**

L

Language **46**

M

Menus
 Audio **35**
 Basic **47**
 Channel Setup **37**
 Parent **39**
 Setup **46**
 Timer **45**
 Video **34**
Mode
 Movie **34**
 Sports **34**
 Standard **34**
 Vivid **34**
MTS
 Auto SAP **36**
 Mono **36**
 Stereo **36**

P

Parental Control **40**
Picture **34**
Picture in Picture (PIP)
 RM-181 **24**
 RM-Y182 **26**

R

Ratings
 English Rating **44**
 French Rating **44**
 Movie Rating **42**
 TV Rating **42**
 U.S.A. Rating **42**
 Unrated **43**
Remote Control
 Programming **49**
 RM-Y181 **3**
 RM-Y182 **5**

S

Setting the Rating **40**

Sharpness **34**

SLEEP

RM-181 **5**

RM-Y182 **5**

Speaker **36**

Specifications **55**

Steady Sound **35**

T

Tilt Correction **46**

Timer 1 and Timer 2 **45**

Treble **35**

Troubleshooting **52**

TV Features **1**

TV Front Panel **2**

TV Rear Panel **8**

V

V-Chip (see Parental Control)

Video Label **46**

W

Wireless Headphones

Batteries **29**

PIP **31**

FD Trinitron
WEGA®



Manual de Instrucciones

Lea este manual antes de operar el producto

ADVERTENCIA

Para evitar el riesgo de incendio o descarga eléctrica, no exponga el televisor a la lluvia o humedad.



Este símbolo señala al usuario la presencia de voltaje peligroso sin aislamiento en el interior del aparato de tal intensidad que podría presentar riesgo de descarga eléctrica.



Este símbolo indica al usuario que el manual que acompaña a este aparato contiene instrucciones importantes referentes a su funcionamiento y mantenimiento.

Nota para el instalador de CATV

Esta nota pretende llamar la atención del instalador del sistema CATV en relación con el artículo 820-40 de la NEC que proporciona las pautas para una adecuada conexión a tierra y, en particular, especifica que el cable de conexión a tierra debe estar conectado al sistema de toma de tierra del edificio lo más cerca posible de la entrada del cable.

PRECAUCIONES DE SEGURIDAD

- Utilice el televisor con ca (corriente alterna) como se menciona a continuación para todos los países excepto en donde se indique:
ca 120 V 60 Hz
ca 220 V 50/60 Hz (Chile, Perú, Bolivia)
- Una terminal del enchufe es más ancha que la otra para garantizar la seguridad y solo se podrá introducir en la toma de corriente de una manera (sólo los modelos con ca 120 V). Si no puede insertar completamente el enchufe en la toma, póngase en contacto con su proveedor.
- Si se introduce algún objeto sólido o líquido en el televisor, desconéctelo y haga que sea revisado por personal especializado antes de volver a utilizarlo.

PRECAUCIÓN

PARA EVITAR DESCARGAS ELÉCTRICAS, INTRODUZCA EL ENCHUFE EN EL TOMACORRIENTE POR COMPLETO, CON EL CONTACTO ANCHO DEL ENCHUFE EN LA RANURA ANCHA DEL TOMACORRIENTE.

Al usar videojuegos, computadoras y productos similares con el televisor, mantenga los ajustes de brillo y contraste a un nivel moderado. Si una imagen inmóvil permanece en la pantalla durante un periodo prolongado con elevada intensidad de brillo o contraste, la imagen podría quedar grabada en la pantalla en forma permanente. Igualmente, ver continuamente el mismo canal de televisión podría dejar grabada en la pantalla el logotipo de la emisora. La garantía no cubre este tipo de anomalías, ya que se deben al mal uso del aparato.



Para reducir el riesgo de descarga eléctrica, no utilice el enchufe polarizado con un cable de extensión, un receptáculo ni otras tomas, a menos que las terminales estén bien insertadas y no queden expuestas.



Se advierte que cualquier cambio o modificación que no se apruebe de modo explícito en este manual podría anular su autorización para utilizar este equipo.

NOTIFICACIÓN

Este aparato ha sido debidamente probado, comprobándose que cumple con los límites impuestos a dispositivos digitales Clase B de acuerdo con la Sección 15 de las normas de la FCC. Estos límites se establecieron para ofrecer protección razonable contra interferencias perjudiciales en las instalaciones residenciales. Este aparato genera, usa y puede emitir energía radioeléctrica. De no instalarse y utilizarse de acuerdo con las instrucciones correspondientes, podría producir interferencias perjudiciales en las radiocomunicaciones. No obstante, no puede garantizarse que no se produzcan estas interferencias en una instalación determinada. Si este aparato llega a interferir en la recepción de radio o televisión, lo que podrá comprobarse encendiendo y apagando el aparato, se recomienda al usuario intentar corregir la interferencia mediante una o más de las siguientes medidas:

- Reoriente o cambie de lugar las antenas receptoras.
- Aumente la distancia que separa este aparato del receptor afectado.
- Conecte el aparato en una toma de corriente de un circuito distinto al que esté conectado el receptor que está afectado.
- Consulte con el distribuidor o solicite los servicios de un técnico capacitado en radio y televisión. Cualquier cambio o modificación que no se detalla expresamente en el presente manual podría invalidar su autorización para emplear este aparato.

Protección del televisor

- Para evitar el sobrecalentamiento interno, no obstruya los orificios de ventilación.
- No instale el televisor en un lugar con temperatura elevada, humedad, exceso de polvo o donde puedan producirse vibraciones.

Nota sobre Caption Vision

Este receptor de televisión proporciona pantalla de televisión con visualización de subtítulos de acuerdo con el punto § 15.119 del reglamento de la FCC.

El uso del televisor con finalidades distintas a la visualización privada de emisiones de programas en UHF o VHF o transmisiones vía cable dirigidas al público en general puede requerir la autorización de la compañía de emisión por cable y/o del propietario del programa.

Información para el propietario

Los números de serie y modelo están situados en la portada de este manual y en la parte posterior del televisor.

Marcas comerciales y derechos de autor

ENERGY STAR® es una marca registrada.



Con licencia de BBE Sound, Inc. bajo USP 4638258.4482866. BBE y el símbolo BBE son marcas comerciales de BBE Sound, Inc.

WOW y el símbolo (●)® son marcas comerciales de SRS Labs, Inc. La tecnología WOW se ha incorporado bajo licencia de SRS Labs, Inc.

Normas importantes sobre seguridad

Para su protección, lea detenidamente estas instrucciones y guarde este manual para futuras consultas.

Lea cuidadosamente todas las advertencias y precauciones y siga las instrucciones inscritas en el televisor o descritas en el manual de instrucciones o de reparación.

ADVERTENCIA

Para protegerse contra daños personales, siga las precauciones de seguridad básicas durante la instalación, la utilización y el mantenimiento del televisor indicadas a continuación.

USO

Fuentes de alimentación

Este televisor solamente deberá alimentarse con el tipo de fuente de alimentación indicado en la etiqueta de serie/modelo. Si no está seguro sobre el tipo de red eléctrica de su hogar, consulte a su proveedor o a la compañía de suministro eléctrico local. En caso de un televisor diseñado para alimentarse con baterías, consulte su manual de instrucciones.



Conexión a tierra o polarización

Este aparato cuenta con cable eléctrico con clavija polarizada (con una terminal más ancha que la otra), o con tres terminales (la tercera es para la conexión). Siga las instrucciones indicadas a continuación:

Para los equipos con un enchufe de cable de alimentación de ca polarizado

El enchufe se introduce en la toma de corriente en una única dirección. Se trata de una característica de seguridad. Si no puede insertar completamente el enchufe en la toma, intente girar el enchufe. Si sigue teniendo problemas para insertar el enchufe, póngase en contacto con su electricista para que le instale una toma adecuada. No ponga a prueba la finalidad de seguridad del enchufe polarizado forzándolo.



Advertencia alternativa

Para los equipos con un enchufe de ca con tres cables de conexión de tierra

Este enchufe únicamente se acoplará a una toma de corriente de conexión a tierra. Se trata de una característica de seguridad. Si no puede insertar el enchufe en la toma, póngase en contacto con su electricista para que le instale una toma adecuada. No ponga a prueba la seguridad del enchufe de conexión a tierra.

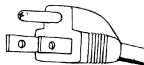

Sobrecarga

No sobrecargue las tomas de pared, los cables de extensión ni los receptáculos más allá de su capacidad, puesto que podría producirse un incendio o una descarga eléctrica. Apague siempre el aparato cuando no lo utilice. Si no va a utilizar el aparato durante un tiempo prolongado, desconéctelo de la toma de pared como precaución ante la posibilidad de que se produzca un mal funcionamiento interno que pueda provocar un incendio.

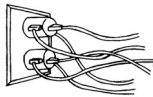

No desconecte la antena ni el cable de alimentación en caso de tormenta. Los relámpagos podrían descargar mientras sujeta el cable y provocarle lesiones graves. Apague el televisor y espere que el tiempo mejore.



Introducción de objetos y líquidos

No introduzca objetos de ningún tipo a través de las ranuras del gabinete, ya que podrían tocar puntos de tensión peligrosa o provocar cortocircuitos de piezas, lo que podría resultar en incendios o descargas eléctricas. No derrame nunca ningún tipo de líquido sobre el televisor.



Accesorios

No utilice ningún accesorio no recomendado por el fabricante, ya que podría ser peligroso. No coloque ningún tipo de objetos, especialmente objetos pesados, encima del aparato. Podrían caerse del aparato y causar lesiones.



Limpieza

Antes de limpiar el televisor, desconéctelo de la alimentación. No utilice limpiadores líquidos ni aerosoles. Para limpiar el exterior del televisor, emplee un paño ligeramente humedecido en agua.



Si se produce un ruido continuo o intermitente en el interior del aparato de televisión mientras está en funcionamiento, desconecte el televisor y póngase en contacto con el proveedor o con el servicio de asistencia técnica. Es normal que algunos aparatos de televisión produzcan ocasionalmente este tipo de ruidos, especialmente cuando se conectan y desconectan.



Instalación

Para levantar o mover el aparato siempre se deberá hacer entre dos o más personas. El aparato es pesado y la superficie inferior es plana. Si intenta mover el aparato sin ayuda o lo manipula de forma insegura, puede producirse lesiones graves. Instale el aparato sobre una superficie plana y estable.

Agua y humedad

No utilice aparatos de alimentación eléctrica cerca del agua — por ejemplo, cerca de una bañera, un lavabo, un fregadero o una lavadora, en un sótano húmedo, ni cerca de una piscina, etc.



Colocación

No coloque el televisor sobre una mesita con ruedas, un pedestal, una mesa o un estante inestable. El televisor podría caer, causando daños serios a niños, adultos y al propio televisor. Utilice solamente la mesita de ruedas o soporte recomendado por el fabricante para el modelo específico. La combinación de un televisor y un mueble con ruedas deberá moverse con cuidado. Las paradas bruscas, la fuerza excesiva y las superficies desiguales pueden hacer que el aparato y el mueble volqueen.

Desconecte todos los cables del aparato antes de intentar moverlo.

No permita que niños o animales se suban encima del aparato o lo empujen. El aparato podría caerse y causar lesiones graves.



Ventilación

Las ranuras y aberturas en la parte posterior o inferior del televisor son para permitir la ventilación necesaria. Para asegurar la operación fiable del televisor y protegerlo contra el sobrecalentamiento, estas ranuras y aberturas no deberán cubrirse ni bloquearse nunca.

❑ No tape las ranuras ni aberturas con paños ni otros materiales.

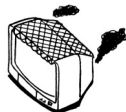

❑ No bloquee las ranuras ni aberturas colocando el televisor sobre una cama, sofá, alfombra u otras superficies similares.

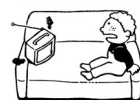

- ❑ No coloque el televisor en un lugar cerrado, como en un librero o un mueble empotrado, a menos que esté adecuadamente ventilado.



- ❑ No coloque el televisor cerca, ni sobre un radiador o una salida de aire caliente, ni expuesto a la luz solar directa.

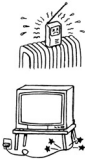

Protección del cable de alimentación

No permita que ningún objeto quede sobre el cable de alimentación, ni coloque el televisor donde el cable pueda quedar sometido a desgaste o presión.

Conexión a tierra o polarización

Este aparato puede estar equipado con un enchufe de línea de corriente alterna polarizado (con una terminal más ancha que la otra). El enchufe sólo se puede introducir en la toma de corriente en una dirección. Se trata de una característica de seguridad. Si no puede insertar completamente el enchufe en la toma, intente girarlo. Si sigue teniendo problemas para introducir el enchufe, póngase en contacto con su electricista para que sustituya la toma obsoleta. No ponga a prueba la seguridad del enchufe polarizado.

Antenas

Conexión a tierra de una antena exterior

Para instalar una antena exterior, siga los procedimientos que se indican a continuación. Los sistemas de antenas exteriores no deben situarse cerca de líneas eléctricas o circuitos de alimentación o luz eléctrica, o bien donde pueda entrar en contacto con dichas líneas eléctricas o circuitos.

CUANDO INSTALE UN SISTEMA DE ANTENA EXTERIOR, EXTREME LAS PRECAUCIONES Y MANTÉNGALO ALEJADO DE DICHAS LÍNEAS ELÉCTRICAS O CIRCUITOS, DADO QUE EL CONTACTO PUEDE RESULTAR FATAL.

Asegúrese de que el sistema de antena tiene conexión a tierra para proporcionar protección contra los incrementos de voltaje y el aumento de las cargas estáticas. El apartado 810 del Código Eléctrico Nacional (NEC) en EE.UU. y el apartado 54 del Código eléctrico de Canadá proporcionan información relativa a la conexión a tierra adecuada del mástil y de la estructura de soporte, la conexión a tierra del cable de conexión a la unidad de descarga de la antena, el tamaño de los conductores de la conexión a tierra, la ubicación de la unidad de descarga de la antena, la conexión de los electrodos de conexión a tierra y los requisitos de los electrodos de conexión a tierra.

Conexión a tierra de la antena de acuerdo con el Código Eléctrico Nacional, ANSI/NFPA 70

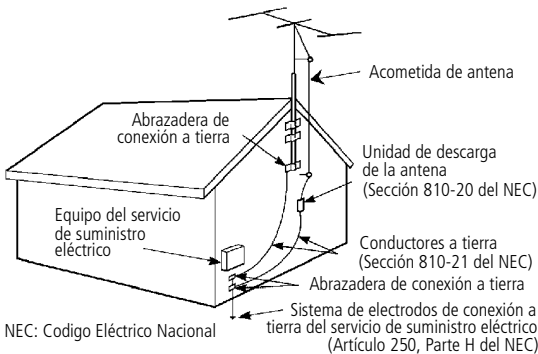

NEC: Código Eléctrico Nacional

Rayos

Para mayor protección del receptor de televisión durante una tormenta con rayos o cuando no se utiliza durante largos periodos de tiempo, desconéctelo de la toma de pared y desconecte la antena. Con ello evitará que los rayos y los incrementos de voltaje dañen el receptor.

Reparación

Daños que requieren reparación

Desconecte el aparato de la toma de pared y haga que sea revisado por personal calificado cuando se produzcan las siguientes condiciones:

- ❑ Si el cable de alimentación o el enchufe están dañados o deshilachados.

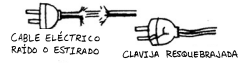

- ❑ Si se ha vertido líquido en el interior del aparato o si se han caído objetos en el interior del producto.



- ❑ Si el aparato se ha expuesto a lluvia o agua.



- ❑ Si el aparato se ha caído y ha sufrido golpes excesivos o si se ha dañado la unidad.



- ❑ Si el aparato no funciona con normalidad al seguir las instrucciones del manual. Ajuste solamente los controles que se especifican en el manual de instrucciones. El ajuste inadecuado de otros controles puede provocar daños y a menudo requerirá mucho trabajo por parte de un técnico calificado para restablecer el funcionamiento normal del aparato.



- ❑ Si el aparato muestra un cambio de rendimiento significativo, debe repararse.

Asistencia técnica

No intente reparar por sí mismo el aparato ya que al abrir el gabinete se vería expuesto a tensiones peligrosas y otros riesgos. Solicite los servicios de personal de reparación calificado.



Piezas de reemplazo

Si necesita piezas de reemplazo, asegúrese de que el técnico certifique por escrito que ha utilizado piezas de reemplazo especificadas por el fabricante con las mismas características que las piezas originales. El uso de piezas no autorizadas puede provocar incendios, descargas eléctricas y otros peligros.



Comprobación de seguridad

Después de realizar cualquier reparación del aparato, solicite al técnico de la reparación que realice comprobaciones rutinarias de seguridad (como especifica el fabricante) para determinar si el aparato se encuentra en condiciones seguras de funcionamiento y certificarlo. Cuando el aparato llega al final de su vida útil, debe desecharse adecuadamente para evitar una implosión del tubo de la imagen. Consulte a un técnico de reparación calificado para depositar el aparato.



Contenido

Introducción

Características del televisor FD Trinitron WEGA®	1
Acerca de este manual	2
Baterías para el control remoto	2
Controles del menú del panel frontal	2
Uso del control remoto.....	3

Conexión del televisor

Panel posterior del televisor.....	5
Conexiones básicas	7
Conexiones del decodificador.....	8
Conexión de equipo adicional	10

Uso de las funciones básicas

Ajuste automático del televisor	17
Acceso rápido a los menús	18
Uso de Imagen dentro de una imagen (PIP).....	20
Ajustes que pueden afectar el uso de Imagen dentro de una Imagen (PIP)	22

Uso de los menús

Para acceder a un menú.....	23
Uso del menú Video	24
Uso del menú Audio	25
Uso del menú Canal	27
Uso del menú Bloqueo de Canal	29
Uso del menú Timer (Reloj)	30
Uso del menú Ajustes.....	31
Uso del menú Básico	32

Información adicional

Programación del control remoto.....	33
Solución de problemas	36
Especificaciones.....	38

Índice alfabético	39
--------------------------------	----

Introducción

Gracias por la compra del televisor FD Trinitron WEGA® de Sony. Antes de utilizar este manual, compruebe el número de modelo situado en la parte posterior del televisor o en la portada de este manual.

Características del televisor FD Trinitron WEGA®

Algunas de las características que disfrutará son:

- ❑ **FD Trinitron CRT Plano** — Su cinescopio tecnológicamente avanzado ofrece una imagen con precisión absoluta y notable detalle.
- ❑ **Entradas Y, Pb, Pr** — Conexión de entrada de video para una calidad de imagen superior.
- ❑ **WOW** — Una nueva función de audio que proporciona un excelente sonido con bajos profundos e intensos. Al activar WOW, BBE se activa directamente para mejorar aún más el programa de audio.
- ❑ **TruSurround** — Produce un sonido tridimensional dinámico en las señales audio estéreo.
- ❑ **Función de bloqueo de canales** — Una herramienta para ayudar a que los padres controlen lo que ven sus hijos bloqueando algunos canales.
- ❑ **ClearEdge VM**—Aumenta la definición de la imagen al proporcionar un contorno limpio y nítido a los objetos.
- ❑ **DynaBlack** — Mejora el contraste y hace más nítidos los detalles de las imágenes.
- ❑ **Imagen dentro de una Imagen (PIP)**— Le permite ver dos canales al mismo tiempo.
- ❑ **Canales Favoritos** — Acceso instantáneo a sus canales favoritos con sólo presionar un botón.
- ❑ **Info** — Una función nueva y práctica que muestra el nombre y el tiempo restante del programa en curso, si la información está disponible.
- ❑ **Control Remoto Universal** — Puede programar el control remoto para operar con él su decodificador de cable, videograbadora, receptor de satélite digital o reproductor DVD.
- ❑ **Energy Star®** — Cumple con las directivas Energy Star de eficiencia en el uso de la energía eléctrica.
- ❑ **Controles del Panel Frontal** — Permiten el acceso a los menús de pantalla sin el control remoto.
- ❑ **Entradas de A/V frontales** — Conexión rápida para videojuegos, cámaras de video y equipos estéreo/mono.
- ❑ **Silenciamiento automático** — Función diseñada para silenciar automáticamente el televisor cuando no se reciben señales.

Acerca de este manual

Este manual proporciona instrucciones para ayudarle a disfrutar de su nuevo televisor. Muestra como conectarlo a la antena o el cable, al decodificador de cable, a la videograbadora, al reproductor de DVD, al receptor de satélite, al sistema estéreo o a la cámara de video. Una vez conectado, siga las instrucciones y utilice el control remoto para acceder a los menús de pantalla.

Baterías para el control remoto

Introduzca dos baterías de tipo AA (R6) (incluidas) en el control remoto como se muestra en la siguiente ilustración.

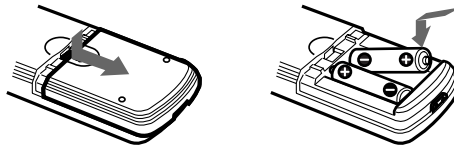

✎ En condiciones de uso normales, las baterías tienen una duración máxima de seis meses. Si el control remoto no funciona correctamente, es posible que las baterías estén gastadas.

✎ Si no va a utilizar el control remoto durante largo tiempo, quite las baterías para evitar posibles daños por fugas.

Controles del menú del panel frontal

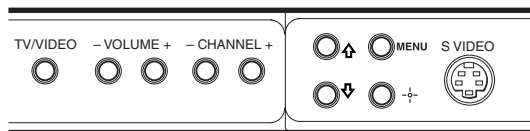

Los controles del panel de audio y video frontal le permiten acceder al menú sin utilizar el control remoto.

- ❑ Presione ^{MENU} para que aparezca el menú en pantalla.
- ❑ Use los botones \uparrow y \downarrow del panel frontal de audio y video en lugar del control remoto.
- ❑ Utilice el botón \leftarrow del panel frontal de audio y video para navegar \leftarrow o \rightarrow y después seleccione un elemento.



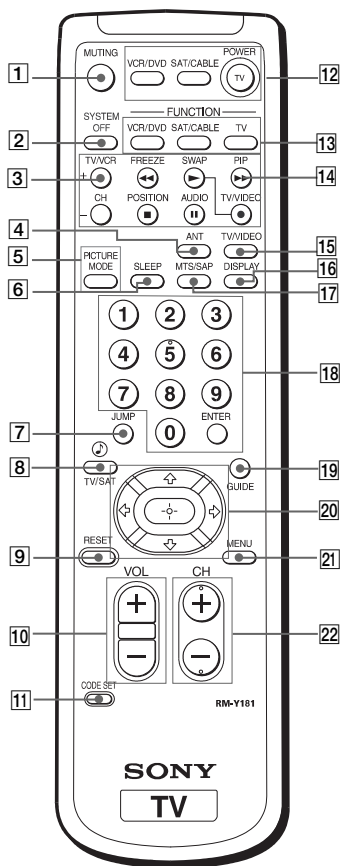

✎ Para navegar por los menús con el control remoto, consulte "Uso de los menús" en la página 23.

Uso del control remoto

Esta sección le muestra cómo utilizar todos los botones del control remoto.



Botón	Descripción
1 MUTE	Presione para desactivar el sonido. Presiónelo de nuevo o presione $\text{VOL} \left[+ \right]$ para restaurar el sonido.
2 SYSTEM OFF	Presiónelo para apagar todos los aparatos Sony al mismo tiempo. Es posible que no funcione con aparatos antiguos.
3 TV/VCR	Presiónelo cuando haya terminado de utilizar la videograbadora y desee pasar a la entrada de ANT/CABLE. La videograbadora permanecerá encendida.
4 ANT (antena)	Presiónelo para cambiar la entrada de VHF/UHF a AUX.
5 PICTURE MODE	Presione repetidamente para recorrer las modalidades de video disponibles: Viva, Estándar, Película y Deportiva. Esta función se encuentra también en el Menú de Video. Consulte "Uso del Menú de Video" en la página 24 para más detalles.
6 SLEEP	Presione repetidamente hasta que aparezca el número de minutos (15, 30, 45, 60 o 90) que quiera tener encendido el televisor antes de apagarse automáticamente. Para cancelar este modo, presione el botón hasta que aparezca SLEEP OFF. Estando en modo de Reposo, presiónelo una vez para ver el tiempo restante.
7 JUMP	Presione para alternar entre dos canales. El televisor cambia del canal actual al último canal seleccionado.
8 TV/SAT	Presione para alternar entre las entradas TV y SAT (satélite) cuando esté en modo SAT FUNCTION.
	Presione para acceder directamente a los ajustes de Efecto de Audio (Simulado, WOW, TruSurround, No), cuando el control remoto esté en modo TV FUNCTION. Consulte "Uso del Menú Audio" en la página 25 para más detalles.
9 RESET	Presiónelo para volver a la configuración de fábrica cuando esté en un menú de pantalla.
10 VOL (volumen)	Presiónelo para ajustar el volumen.
11 CODE SET	Programe con él su control remoto para que pueda operar el equipo de video conectado al televisor (consulte "Programación del control remoto" en la página 33).

Botón	Descripción
12 Botones POWER	Presiónelos para encender y apagar el equipo conectado.
13 Botones FUNCTION	Presiónelos para controlar el equipo conectado con su control remoto.
14 PIP (imagen dentro de una imagen)	Presiónelo para operar la función PIP. Consulte "Uso de Imagen dentro de una imagen (PIP)" en la página 20.
VCR (Funcionamiento)	Presione para operar su grabadora. La grabadora deberá estar programada en el control remoto, (consulte "Programación del control remoto" en la página 33).
	Rebobinar.
REC	Presione el botón  y el botón en blanco (arriba a la izquierda) al mismo tiempo para grabar programas con su videocasetera (el control remoto debe haberse programado para poder utilizar esta opción).
	Avance rápido.
	Reproducir.
	Parar.
II	Pausa. Presiónelo de nuevo para reanudar la reproducción normal.
15 TV/VIDEO	Presiónelo para alternar entre las entradas de video disponibles.
16 DISPLAY	Presione una vez para ver la hora actual, el nombre del canal (si se ha definido) y el número del canal. Presiónelo nuevamente para desactivar la función. Consulte "Uso del Menú Timer (Reloj)" en la página 30 para conocer más detalles.
17 MTS/SAP	Presiónelo para recorrer las opciones de Sonido Multicanal del televisor (MTS): Estéreo, Mono y Auto SAP (Segundo Programa de Audio).
18 0-9 y ENTER	Presiónelo para cambiar los canales directamente y para introducir valores numéricos en la pantalla.
19 GUIDE	Presiónelo para mostrar la guía de programas de su antena de satélite.
20	Presione los botones con flechas para mover el cursor en los menús en pantalla. Presione el botón central para seleccionar una opción o acceder a ella.
21 MENU	Presione este botón para ver el menú en pantalla. Presiónelo de nuevo para salir del menú en cualquier momento.
22 CH (canal)	Presione para cambiar de canal.

 Para obtener información sobre los botones de operación de Imagen dentro de una imagen (PIP), consulte la página 21.

 Si pierde su control remoto, consulte la página 37.

Conexión del televisor

Lea esta sección antes de instalar el televisor por primera vez. Esta sección hace referencia a las conexiones básicas, así como a cualquier otro equipo opcional que conecte.

Panel posterior del televisor

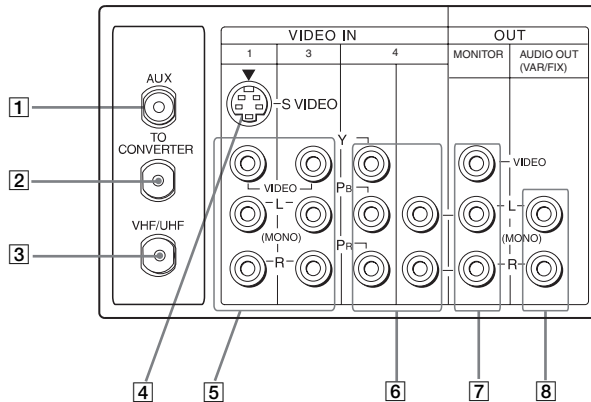

Toma	Descripción
1 AUX	Le permite ver los canales locales y de cable si su servicio de cable no ofrece los primeros. Usted puede cambiar entre los canales locales y los del cable si oprime ANT en el control remoto. Los aparatos conectados a la entrada AUX no podrán verse en PIP.
2 TO CONVERTER	Ésta es una salida de VHF/UHF que le permite programar su televisor para cambiar entre canales codificados (mediante decodificador) y los canales normales de televisión por cable. Use esta salida en lugar de un conector en Y para obtener una mejor calidad de imagen cuando necesite cambiar entre canales de cable codificados y decodificados.
3 VHF/UHF	Establece una conexión con el cable o la antena de VHF/UHF.
4 S VIDEO	Establece una conexión con la toma S VIDEO OUT (salida de S VIDEO) de la videograbadora o de otro equipo de video con S VIDEO. S VIDEO proporciona una mejor calidad de imagen que las tomas VHF/UHF o la toma de entrada de video. Como S VIDEO no proporciona sonido, debe conectar los cables de audio de todas formas.

Toma	Descripción
5 VIDEO/AUDIO (L/R)	Establece una conexión con las tomas de salida de AUDIO y VIDEO de la videograbadora o de otro equipo de video. En el panel frontal del televisor existe una tercera toma de entrada de video (VIDEO 2). Estas tomas de entrada de AUDIO/VIDEO proporcionan una mejor calidad de imagen que la toma VHF/UHF.
6 Y, P_B, P_R/ L, R	Se conecta a las tomas de entrada de video para componentes Y, P _B , P _R y las tomas AUDIO L y R del reproductor de DVD o la caja decodificadora digital.
7 MONITOR OUT	Le permite grabar en la videograbadora el programa que está viendo. Cuando hay dos videograbadoras conectadas (consulte "Conexión de dos videograbadoras para grabar cintas" en la página 12), puede utilizar el televisor como monitor para editar de cinta a cinta.
8 AUDIO OUT (VAR/FIX) L(MONO)/R	Se conecta a las tomas de entrada AUDIO L y R del equipo de audio o video. Puede escuchar el sonido del televisor con el equipo de sonido.

Conexiones básicas

Televisor con antena interior o exterior o cable CATV

Dependiendo del cable que tenga, elija una de las siguientes conexiones:

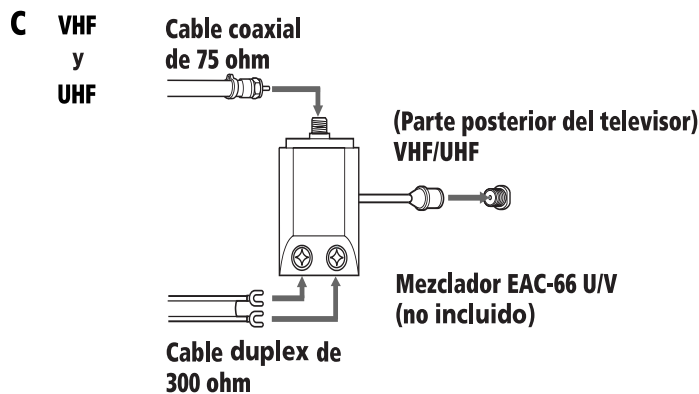
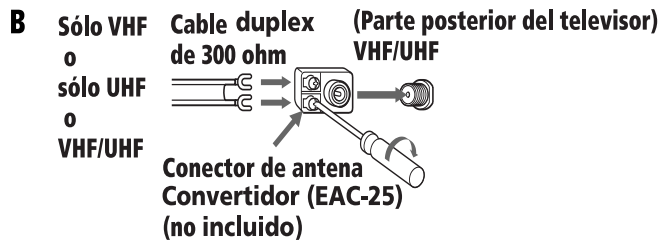
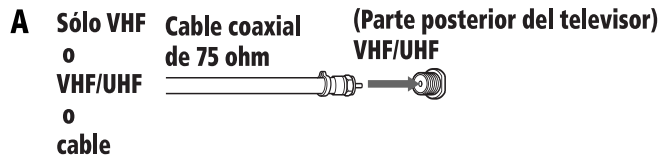

 Si conecta el televisor a una antena interior o exterior, es posible que deba ajustar la orientación de la antena para obtener una mejor recepción.

Conexiones del decodificador

Algunos sistemas de televisión por cable usan señales codificadas que requieren de un decodificador para poder ver todos los canales. Si está suscrito a ese tipo de servicio de cable, utilice esta conexión. Las señales codificadas que lleguen al televisor desde el decodificador no pueden verse en PIP. Si algunos de sus canales están codificados, tome en consideración la posibilidad de utilizar la conexión de Decodificador y cable.

Decodificador y televisor

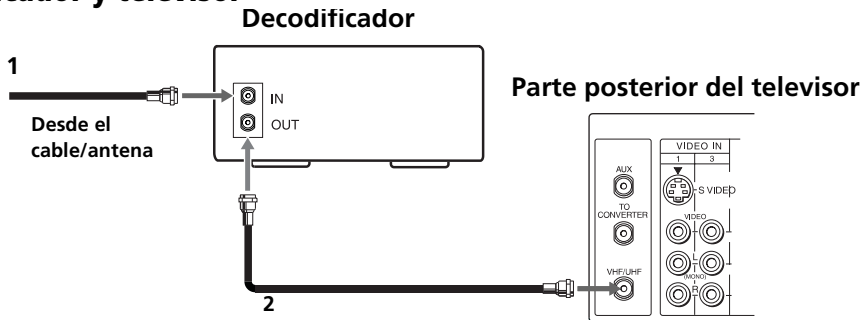

- 1 Conecte el cable coaxial de su servicio de cable a la toma IN del decodificador.
- 2 Conecte un cable coaxial (no incluido) desde la toma OUT del decodificador a la toma VHF/UHF del televisor.

 Si desea controlar toda la selección de canales con el decodificador, es aconsejable utilizar la función Fijar Canal ajustando el televisor en el canal 3 o el 4 (consulte la página 27).

Decodificador y cable

Utilice esta conexión si está suscrito a un sistema de cable que codifique algunos canales (canales de pago) pero no todos. Esta configuración le permite utilizar el control remoto para:

- cambiar de canal por medio del decodificador cuando esté recibiendo una señal codificada
- cambiar de canal por medio de su televisor

Esta conexión también le permite utilizar la función PIP cuando esté viendo canales no codificados que lleguen directamente a su televisor por el cable. Las señales codificadas que lleguen desde el decodificador no pueden verse en PIP. Para obtener más información sobre la función PIP, consulte la página 20.

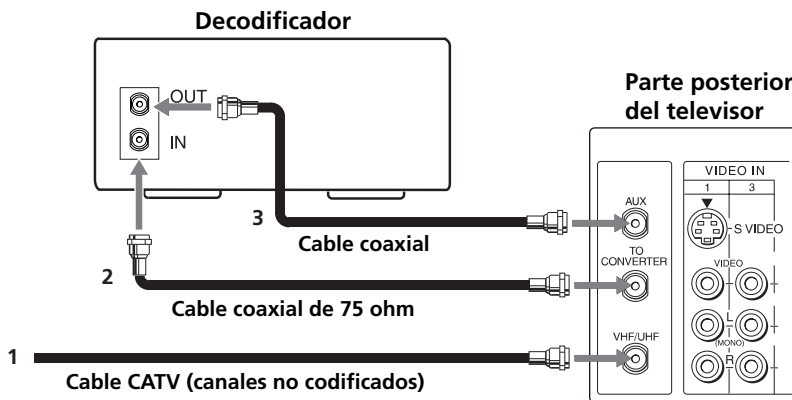

- 1** Conecte el cable coaxial del servicio de cables a la toma VHF/UHF del televisor.
- 2** Conecte la toma IN del decodificador a la toma TO CONVERTER del televisor mediante un cable coaxial (no incluido).
- 3** Conecte la toma OUT del decodificador a la toma AUX del televisor mediante un cable coaxial (no incluido).

Presione el botón ANT del control remoto para alternar las entradas de decodificador y de cable directo.

Su control remoto Sony puede programarse para que opere el decodificador (consulte la página 34).

Si desea utilizar el decodificador para cambiar de canal, ponga el televisor en el canal 3 o 4. Ajuste la función Fijar Canal para asegurarse de que no cambia accidentalmente los canales por medio del televisor (consulte la página 27).

Conexión de equipo adicional

Conexión de un televisor y una videgrabadora

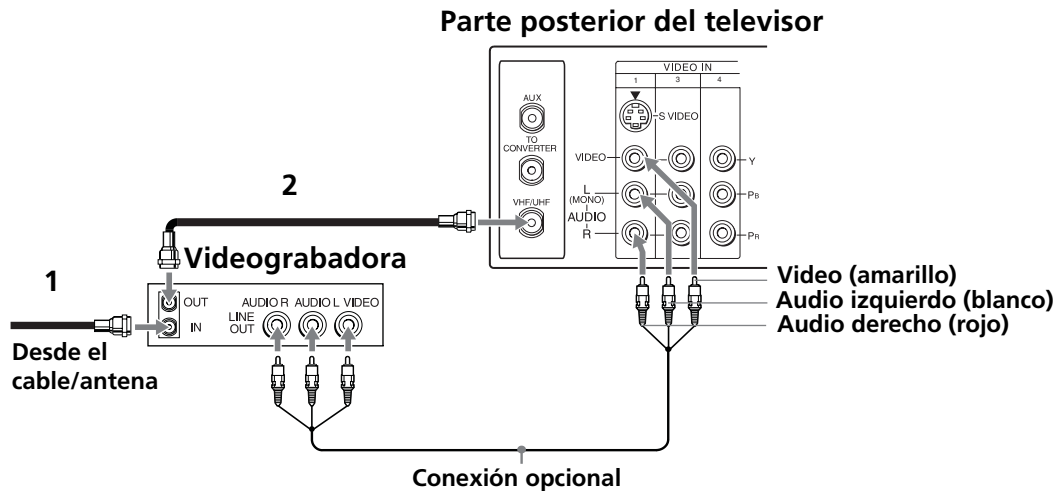

Para ver programas de video desde la videgrabadora, sintonice el televisor en los canales 3 ó 4 (como se indica en la parte posterior de la videgrabadora).

- 1** Conecte el cable coaxial de la antena del televisor o del servicio de cable a la toma IN de la videgrabadora.
- 2** Conecte el cable coaxial (no incluido) de la toma OUT de la videgrabadora a la toma VHF/UHF del televisor.

Conexión opcional

Si la videgrabadora dispone de salidas de video, puede obtener una mejor calidad de imagen conectando los cables de audio y video (no incluidos) desde la salida AUDIO y VIDEO OUT de la videgrabadora a la toma AUDIO/VIDEO IN del televisor.

Puede utilizar el **TV/VIDEO** botón para cambiar entre las entradas VHF/UHF y VIDEO.

Para obtener una mejor calidad de imagen, utilice S VIDEO en lugar del cable amarillo de audio y video. Como S VIDEO no proporciona sonido, debe conectar los cables de audio de todas formas.

Conexión de un televisor, una videograbadora y un decodificador

Utilice esta conexión si está suscrito a un sistema de cable que codifique algunos canales (canales de pago) pero no todos. Esta configuración le permite utilizar el control remoto para:

- ❑ cambiar de canal con el decodificador o la videograbadora mientras recibe una señal codificada
- ❑ cambiar de canal con el televisor

Esta conexión también le permite utilizar la función PIP mientras ve canales no codificados que lleguen directamente a su televisor por el cable. Las señales codificadas que lleguen desde el decodificador no pueden verse en PIP. Para obtener más información sobre la función PIP, consulte la página 20.

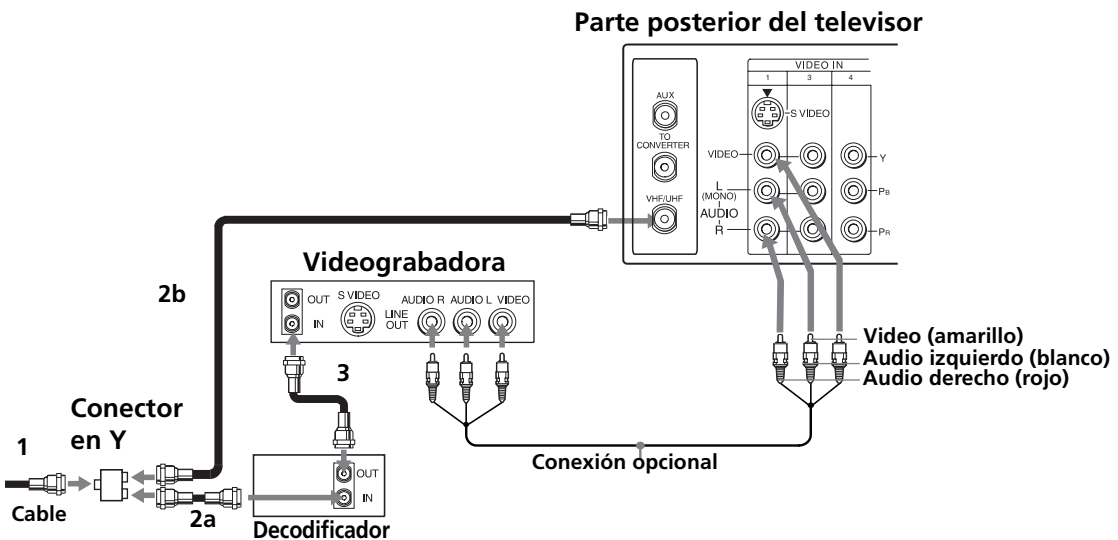

- 1** Conecte la toma unida de entrada del conector en Y a su conexión de cable de entrada.
- 2** Con un cable coaxial (no incluido), conecte las dos tomas de salida del conector en Y a:
 - a)** la toma IN del decodificador y
 - b)** la toma VHF/UHF del televisor.
- 3** Conecte la toma OUT del decodificador a la toma IN de la videograbadora con un cable coaxial (no incluido).

Si desea controlar toda la selección de canales a través del decodificador, es aconsejable utilizar la función Fijar Canal ajustando el televisor en el canal 3 o 4 (consulte la página 27).

Conexión opcional

Si la videograbadora tiene salidas de video, podrá obtener una mejor calidad de imagen si conecta los cables de audio y video (no incluidos) desde la salida AUDIO y VIDEO OUT de la videograbadora a la toma de entrada AUDIO/VIDEO IN del televisor.

Para obtener una mejor calidad de imagen, utilice S VIDEO en lugar del cable amarillo de audio y video. Como S VIDEO no proporciona sonido, debe conectar los cables de audio de todas formas.

Puede utilizar el  botón para cambiar entre las entradas VHF/UHF y VIDEO.

Conexión de dos videograbadoras para grabar cintas

Puede conectar dos videograbadora para editar cintas de video. También puede conectarlas a su televisor para ver el programa que esté grabando.

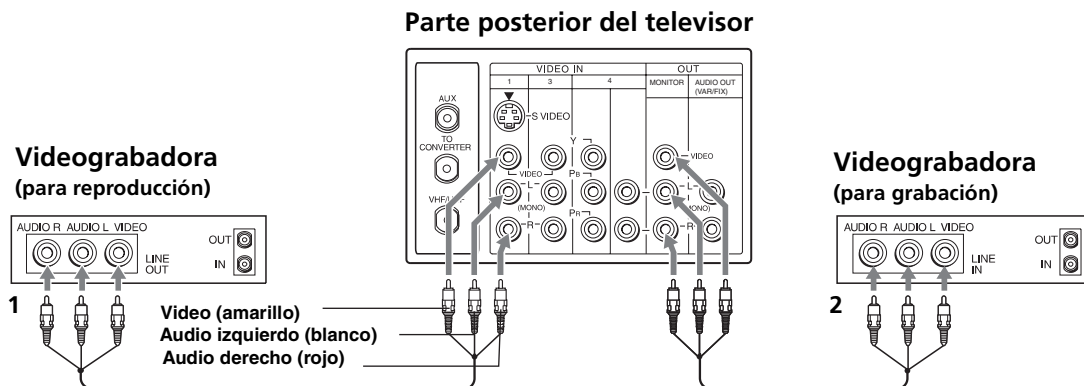

- 1** Use cables de audio y video (no incluidos) para conectar las tomas de AUDIO y VIDEO OUT de la primera videograbadora a las de AUDIO y VIDEO IN del televisor.
- 2** Use cables de audio y video (no incluidos) para conectar las tomas de AUDIO y VIDEO IN de la segunda videograbadora a las de MONITOR AUDIO y VIDEO OUT del televisor.

Para editar cintas, presione  para ajustar el televisor en la entrada de video que desee reproducir.

Conexión de un televisor y un receptor de satélite

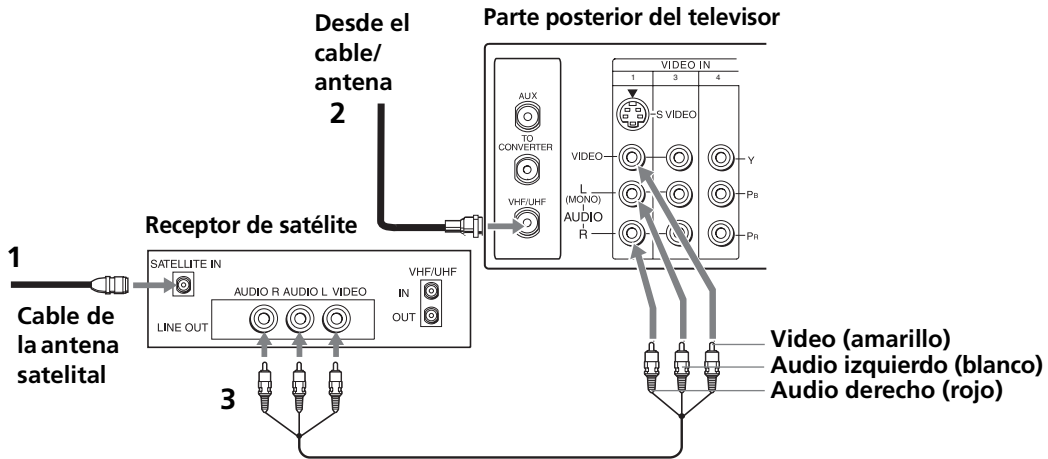

- 1** Conecte el cable de la antena por satélite a la entrada SATELLITE IN del receptor de satélite.
- 2** Conecte el cable coaxial del servicio de cable o antena a la toma VHF/UHF del televisor.
- 3** Use cables de audio y video (no incluidos) para conectar las tomas AUDIO y VIDEO OUT del receptor de satélite a las de AUDIO y VIDEO IN del televisor.

 Puede utilizar el  botón para cambiar entre las entradas VHF/UHF y VIDEO.

 Para obtener una mejor calidad de imagen, utilice S VIDEO en lugar del cable amarillo de audio y video. Como S VIDEO no proporciona sonido, debe conectar los cables de audio de todas formas.

Conexión de un televisor, un receptor de satélite y una videgrabadora

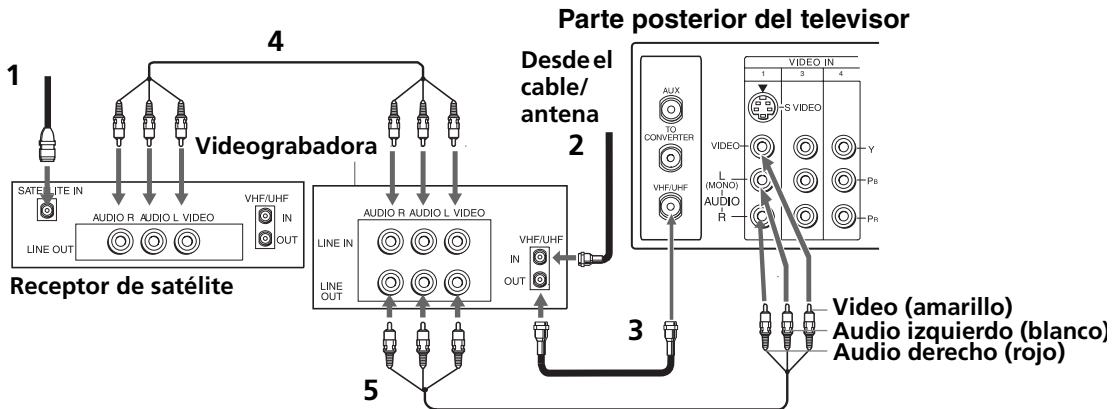

- 1 Conecte el cable de la antena por satélite a la entrada SATELLITE IN del receptor de satélite.
- 2 Conecte el cable coaxial del servicio de cables o antena a la toma IN de la videgrabadora.
- 3 Conecte la toma OUT de la videgrabadora a la toma VHF/UHF del televisor con un cable coaxial (no incluido).
- 4 Use cables de audio y video (no incluidos) para conectar las tomas de AUDIO y VIDEO OUT del receptor de satélite a las de AUDIO y VIDEO IN de la videgrabadora.
- 5 Conecte las tomas AUDIO y VIDEO OUT de la videgrabadora a las tomas AUDIO y VIDEO IN del televisor con cables de audio y video (no incluidos).

🔧 Para ver las imágenes desde el receptor del satélite o la videgrabadora, seleccione la entrada de video a la que esté conectado el receptor de satélite o la videgrabadora presionando TV^{VIDEO} en el control remoto.

Conexión de un reproductor de DVD

Use cables de audio y video (no incluidos) para conectar las tomas de AUDIO y VIDEO OUT del reproductor de DVD a las de VIDEO IN del televisor.

Parte posterior del reproductor de DVD

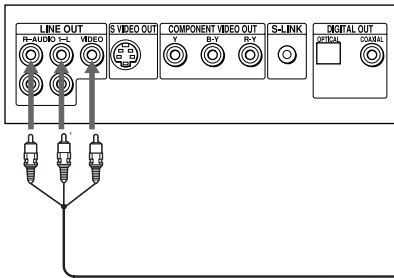

Parte posterior del televisor

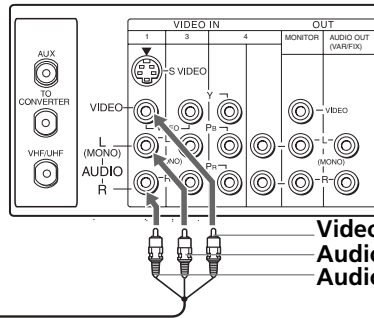

Video (amarillo)
Audio izquierdo (blanco)
Audio derecho (rojo)

Para obtener una mejor calidad de imagen, utilice S VIDEO en lugar del cable amarillo de audio y video. Como S VIDEO no proporciona sonido, debe conectar los cables de audio de todas formas.

Conexión opcional

Si el reproductor de DVD tiene salidas de video para componentes (Y, P_B, P_R), puede optimizar la calidad de imagen con cables de video para componentes.

Parte posterior del reproductor de DVD

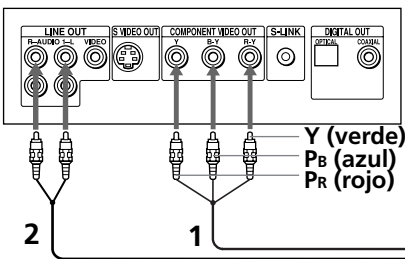

Y (verde)
P_B (azul)
P_R (rojo)

Parte posterior del televisor

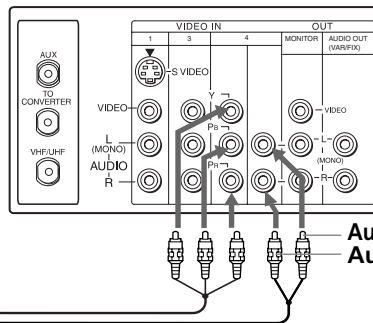

Audio izquierdo (blanco)
Audio derecho (rojo)

- 1 Conecte Y, P_B, P_R OUT de su reproductor de DVD a Y, P_B, P_R IN del televisor con cables de componentes de video (no incluidos).
- 2 Conecte la toma AUDIO OUT del reproductor de DVD a la toma AUDIO IN del televisor.

Las salidas Y, P_B, P_R del reproductor de DVD en ocasiones están marcadas Y, C_B y C_R o Y, B-Y, y R-Y. En tal caso, conecte los cables según el color de las tomas.

Conexión de una cámara de video

Conecte las tomas AUDIO y VIDEO OUT de la cámara de video a las de AUDIO y VIDEO IN del televisor con cables de audio y video (no incluidos).

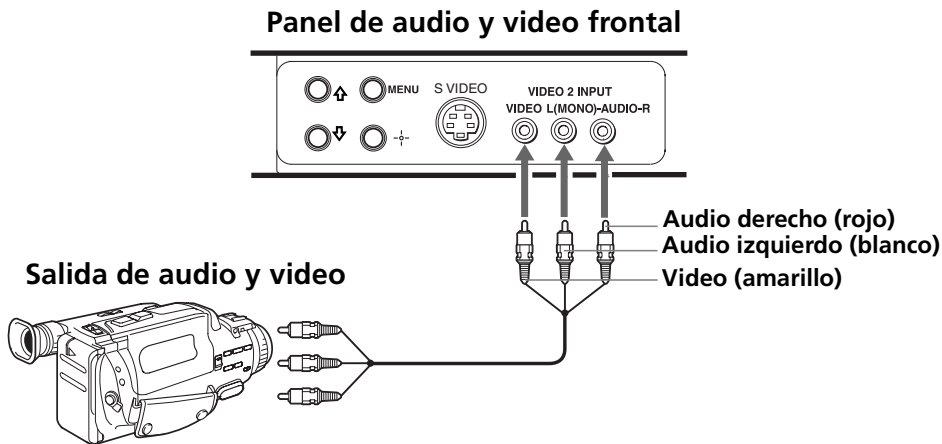

Si la cámara tiene salida de S VIDEO, puede usar un cable de S VIDEO para mejorar la calidad de la imagen. Utilice S VIDEO en lugar del cable amarillo de audio y video. Como S VIDEO no proporciona sonido, debe conectar los cables de audio de todas formas.

Conexión de un sistema de sonido

Conecte AUDIO OUT del televisor a una de las entradas de línea disponibles (por ejemplo TV, AUX, TAPE2) del equipo de sonido con cables de audio (no incluidos).

Parte posterior del televisor

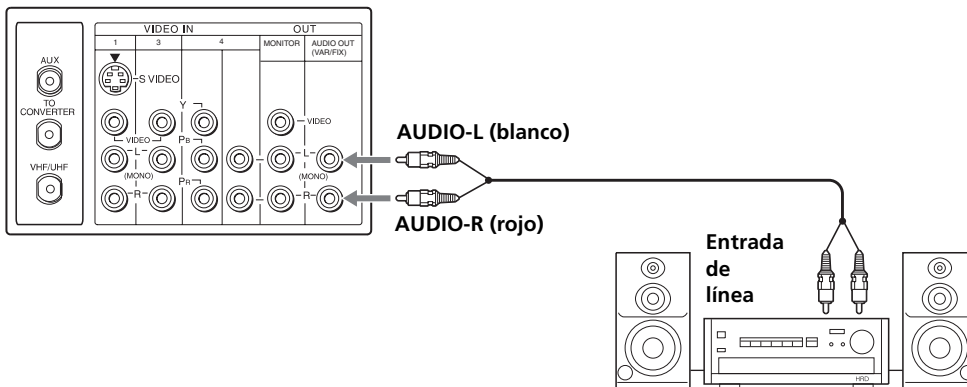

Ajuste el equipo de sonido a la entrada de línea seleccionada. Consulte "Uso del Menú Audio" en la página 25 para obtener más instrucciones sobre la configuración del audio.



Uso de las funciones básicas

Ajuste automático del televisor

Cuando haya terminado de conectar el televisor, puede ajustar los canales con la opción de Autoprogramación.

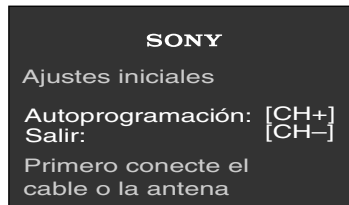









- 1 Presione  para encender el televisor. Aparece la pantalla Ajustes iniciales.



- 2 Presione  en el control remoto o en el panel frontal del televisor para realizar la Autoprogramación, o presione  para salir.

 La pantalla Ajustes iniciales aparecerá cada vez que encienda el televisor hasta que active Autoprogramación.

Para volver a activar Autoprogramación

- 1 Presione .
- 2 Presione  para seleccionar Canal.
- 3 Presione  para seleccionar Cable. Presione  para seleccionar.
- 4 Presione  o  para seleccionar Si o No según el estado del televisor. Presione .
- 5 Presione  para seleccionar Autoprogramación. Presione  para buscar los canales.
- 6 Una vez finalizada la función de Autoprogramación, presione  para salir.

Acceso rápido a los menús

Los ajustes siguientes están disponibles en los menús de pantalla. Para obtener más detalles sobre el uso de los menús, consulte “Uso de los menús” en la página 23.

Menú	Permite
 <p>Video Audio Canal Bloqueo Timer Ajustes Básico</p> <p>Modo: Vívido Contraste Brillo Color Tinte Nitidez Temp. Color: Frío ClearEdge VM: Alto DynaBlack: Alto</p> <p>Mover: [Left][Right] Seleccionar: [Enter] Salir: [MENU]</p>	<p>Modificar los ajustes de la imagen.</p>
 <p>Video Audio Canal Bloqueo Timer Ajustes Básico</p> <p>Agudos Graves Balance Auto Volumen: Sí Efecto: WOW MTS: Estéreo Bocinas: Sí Salida de Audio: Var.</p> <p>Mover: [Left][Right] Seleccionar: [Enter] Salir: [MENU]</p>	<p>Cambiar el ajuste de audio.</p>
 <p>Video Audio Canal Bloqueo Timer Ajustes Básico</p> <p>Canales Favoritos Cable: No Fijar Canal: No Autoprogramación Omitir/Añadir Canal Nombre del Canal</p> <p>Mover: [Left][Right] Seleccionar: [Enter] Salir: [MENU]</p>	<p>Personalizar el ajuste de los canales.</p>
 <p>Video Audio Canal Bloqueo Timer Ajustes Básico</p> <p>Bloqueo de Canal 1: No 2: No 3: No 4: No</p> <p>Mover: [Left][Right] Seleccionar: [Enter] Salir: [MENU]</p>	<p>Bloquear los canales no deseados.</p>

Menú

Permite



Ajustar el reloj del televisor y programar el encendido y apagado automático en un canal establecido mediante Timer 1 y Timer 2 (Reloj 1 y Reloj 2).



Seleccionar los modos de subtítulos, etiquetar las entradas de video, corregir la inclinación de la imagen, seleccionar el idioma de los menús o ejecutar una demostración de los menús.



Obtener acceso rápido a los ajustes de menú de uso más común.

Uso de Imagen dentro de una imagen (PIP)

La función de Imagen dentro de una imagen (PIP) le permite ver dos canales al mismo tiempo, uno en tamaño completo en la pantalla del televisor, y otro en una ventanilla dentro de la pantalla del televisor.

Para ver una Imagen dentro de una imagen

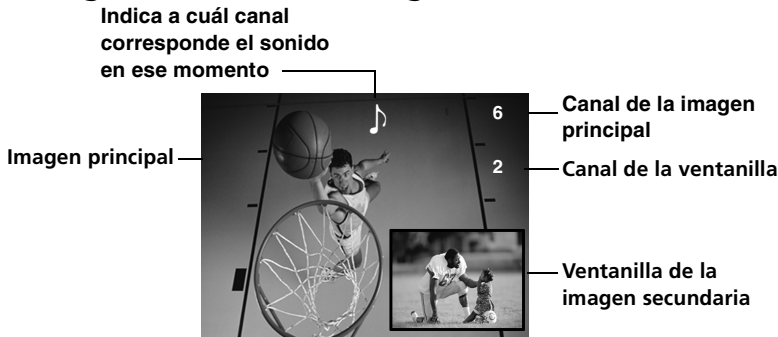

Para usar PIP (Imagen dentro de una Imagen):

- 1 Presione el botón TV FUNCTION del control remoto para ver un canal que se esté emitiendo.
- 2 Presione el botón y aparecerá la ventanilla.
- 3 Use los botones PIP (amarillos) CH +/- para cambiar el canal de la ventanilla.

Para verificar su PIP









- 1 Presione el botón TV FUNCTION del control remoto para ver un canal que se esté emitiendo.
- 2 Presione el botón y seleccione el mismo canal que el de la ventana principal. Usted debe tener ahora el mismo programa en la pantalla principal y en la ventanilla.
- 3 Use los botones amarillos CH +/- para cambiar el canal de la ventanilla.
- 4 Ahora use los botones principales CH +/- de la parte inferior de su control remoto para cambiar el canal en la pantalla principal.
- 5 Presione el botón para cambiar a otras entradas de video de otros aparatos que estén conectados a cualquiera de las tomas VIDEO IN de la parte posterior de su TV. Debe ver una imagen distinta en la ventanilla para cada aparato de video que esté conectado al televisor. Asegúrese de que los aparatos conectados estén encendidos y funcionando cuando haga esta prueba.

- 6** Si la función PIP no funciona correctamente con el televisor o el equipo de video conectado a él, consulte la sección de Solución de problemas que comienza en la página 36 para ver posibles soluciones.

 Si tiene problemas con la función PIP, consulte la sección “Ajustes que pueden afectar el uso de Imagen dentro de una imagen PIP” (página 22) o consulte la sección de Solución de problemas (página 36) para ver posibles soluciones.

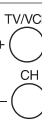
Funciones de botones PIP

Botones de etiqueta amarilla PIP Descripción

	<p>Presione para activar la función PIP. Presione repetidas veces para cambiar el tamaño de la imagen de la ventanilla y desactivar la función PIP.</p>
	<p>Presione para recorrer el equipo de video que tiene conectado al televisor.</p>
	<p>Presiónelo para alternar entre el sonido de la imagen principal y el de la ventanilla. El símbolo de sonido  aparece durante tres segundos, indicándole si el sonido que escucha proviene de la imagen principal o de la ventanilla.</p>
	<p>Presiónelo para cambiar el canal de la ventanilla. Para cambiar el canal de la imagen principal, use los botones CH+/- en la parte inferior del control remoto.</p>
	<p>Presione para cambiar la ubicación de la ventanilla a cualquiera de las cuatro esquinas de la pantalla.</p>
	<p>Presione para congelar la imagen de la ventanilla. Presione el botón de nuevo para restaurar la imagen. La imagen principal sigue funcionando normalmente</p>
	<p>Presione para intercambiar la imagen principal con la de la ventanilla. Presione este botón de nuevo para regresar al estado original.</p>

 No se puede ver la imagen de entrada de AUX en la ventanilla.

 Para obtener más información sobre su control remoto, consulte “Uso del control remoto” en la página 3.

Ajustes que pueden afectar el uso de Imagen dentro de una Imagen (PIP)

- ❑ No podrá verse en la ventanilla PIP ningún equipo de video que tenga usted conectado a la entrada AUX.
- ❑ PIP no funcionará si está usted viendo todos los canales a través de un decodificador. Este dispositivo decodifica una sola señal a la vez, por lo que la imagen en la ventanilla será idéntica a la de la imagen principal.
- ❑ Se puede usar Imagen dentro de una Imagen para ver en su televisor imágenes provenientes de diversas fuentes. Por ejemplo, mediante esta función, se puede ver simultáneamente en la pantalla un canal normal de cable y la imagen generada por una videograbadora, un reproductor de DVD o un receptor satelital. Para lograrlo:
 - 1** Conecte el cable del servicio de televisión por cable en la entrada VHF/UHF en la parte posterior del televisor.
 - 2** Conecte el otro aparato (videograbadora, reproductor de DVD o receptor satelital) en cualquiera de las entradas VIDEO IN en la parte posterior del televisor.
 - 3** Sintonicé una imagen en la imagen principal.
 - 4** Sintonicé una segunda imagen en la ventanilla.









Puede entonces intercambiar las dos imágenes que están en la pantalla del televisor.



 No se puede usar una señal mediante la entrada AUX con Imagen dentro de una Imagen.

Uso de los menús

Esta sección muestra las opciones disponibles para configurar y ajustar el televisor.

Para acceder a un menú

- 1** Presione  para ver el menú en pantalla.
- 2** Utilice los botones  o  para seleccionar el menú deseado y después presione .
- 3** Utilice los botones  o  para seleccionar la opción deseada y después presione .
- 4** Siga las indicaciones que aparecen en pantalla para activar las opciones deseadas. Presione  para terminar el ajuste.
- 5** Presione  para salir del menú.

 Presione  una vez para mostrar el menú en pantalla y presiónelo de nuevo para volver a la vista normal. Si no presiona ningún botón, el menú se cierra automáticamente transcurridos 90 segundos aproximadamente.

Uso del Menú Video



Para acceder al menú Video, siga los siguientes pasos:

Para mostrar



Para seleccionar





Presione  para resaltar la opción deseada y después presione .



Modo

Visualización personalizada de la imagen

Presione  o  para seleccionar una de las siguientes opciones:

- Vívido:** Seleccione este modo para aumentar el contraste y la nitidez de la imagen.
- Estándar:** Seleccione este modo para obtener una imagen estándar.
- Película:** Seleccione este modo para obtener una imagen muy detallada.
- Deportes:** Seleccione este modo para obtener una imagen brillante.













Presione





para acceder directamente a los ajustes de Modo (Vívido, Estándar, Película y Deportes).

Controles de imagen

- Contraste:** Presione  para reducir el contraste de la imagen. Presione  para aumentar el contraste de la imagen.
- Brillo:** Presione  para oscurecer la imagen. Presione  para aumentar el brillo de la imagen.
- Color:** Presione  para reducir la intensidad del color. Presione  para aumentar la intensidad del color.
- Tinte:** Presione  para aumentar los tonos rojos. Presione  para aumentar los tonos verdes.
- Nitidez:** Presione  para suavizar la imagen. Presione  para aumentar la nitidez de la imagen.

Temp. color



Ajuste de la tonalidad del blanco

Presione  o  para seleccionar una de las siguientes opciones y después presione  para seleccionarla.

- Frío:** Proporciona a los colores blancos un tono azulado.
- Neutro:** Proporciona a los colores blancos un tono neutro.
- Cálido:** Proporciona a los colores blancos un tono rojizo.



ClearEdge VM

Definición de imagen

Aumenta la definición de la imagen al proporcionar un contorno limpio y nítido a los objetos. Presione  o  para seleccionar una de las siguientes opciones: **No, Alto, Bajo**.

DynaBlack



Contraste dinámico

Mejora el contraste y hace más nítidos los detalles de las imágenes. Presione  o  para seleccionar una de las siguientes opciones: **No, Alto, Bajo**.











Uso del Menú Audio



Para acceder al menú Audio, siga los siguientes pasos:



Presione  para resaltar la opción deseada y después presione .





Agudos	Presione  para reducir los sonidos agudos. Presione  para aumentar los sonidos agudos.
Graves	Presione  para reducir los sonidos graves. Presione  para aumentar los sonidos graves.
Balance	Presione  para reducir el volumen de la bocina derecha. Presione  para reducir el volumen de la bocina izquierda.
Auto Volumen <i>Estabiliza el volumen</i>	Presione  o  para seleccionar una de las siguientes opciones: Sí: Seleccione esta opción para estabilizar el volumen cuando cambie de canal. No: Seleccione esta opción para desactivar Auto Volumen.
Efecto	Presione  o  para seleccionar una de las siguientes opciones: Simulado: Simula el sonido estéreo de las salas de cine y teatro en los programas mono. WOW: Provee una espectacular presencia del sonido de los graves. Al activar WOW, BBE se activa directamente para mejorar aún más el programa de audio. TruSurround: Produce un sonido tridimensional dinámico en las señales de audio estéreo. No: Recepción mono o estéreo normal.

 Presione  para acceder directamente a los ajustes de Efecto de Audio.

MTS

*Sonido
Multicanal
del televisor*

Presione  o  para seleccionar una de las siguientes opciones:

Estéreo: Seleccione esta opción cuando vea una emisión en estéreo.

Mono: Seleccione esta opción para reducir el ruido en zonas de difícil recepción.



Auto SAP: Seleccione esta opción para que el televisor cambie automáticamente al Segundo Programa de Audio (SAP) al recibir la señal.



Presione  para acceder directamente a los ajustes de MTS (Estéreo, Mono y Auto SAP).

Bocinas

*Selección
personalizada de
la fuente de
salida de audio*



Presione  o  para seleccionar una de las siguientes opciones:

Sí: Seleccione esta opción para escuchar el sonido de las bocinas del televisor con sistema estéreo adicional o sin él.

No: Seleccione esta opción para apagar las bocinas del televisor y escuchar el sonido del televisor únicamente por las bocinas del sistema de audio externo.

Salida de Audio

*Utilícelo para
controlar el
volumen del
televisor con un
equipo de sonido*

Presione  o  para seleccionar una de las siguientes opciones:

Variable: Ajusta el volumen a través del televisor.

Fija: Ajusta el volumen del televisor a través de un dispositivo estéreo conectado.



La función Salida de Audio sólo puede activarse cuando Bocinas se encuentra en la posición No.



Si el televisor se encuentra en el modo Auto SAP, es posible que algunos programas se silencien o se distorsionen. Si el televisor no emite ningún sonido, cambie el ajuste de Audio a Estéreo o Mono.

Uso del Menú Canal



Para acceder al menú Canal, siga los siguientes pasos:

Para mostrar



Para resaltar



Para seleccionar



Presione \downarrow para resaltar la opción deseada y después presione \rightarrow .

- Canales Favoritos**
Acceso rápido a los canales favoritos
- 1 Presione \uparrow o \downarrow para seleccionar la posición (1 a 8) en la que desea ajustar un canal favorito y después presione \rightarrow .
 - 2 Presione \uparrow o \downarrow para desplazarse por los canales hasta encontrar el que desea agregar a sus canales favoritos.
 - 3 Presione \rightarrow para seleccionarlo, esto cambiará su televisor de manera automática al canal que seleccionó.
 - 4 Presione \leftarrow para volver al menú de Canal o presione \rightarrow para salir.

Para usar la opción de Canales favoritos: Salga de todos los menús y presione \rightarrow . Presione \uparrow o \downarrow para desplazar el cursor al número de canal deseado y presione \rightarrow .

- Cable** Presione \uparrow o \downarrow para seleccionar una de las siguientes opciones:
- Sí:** Selecciónelo si recibe canales vía cable.
 - No:** Selecciónelo si utiliza una antena de televisión.

Después de cambiar los ajustes del cable, deberá realizar la función Autoprogramación.

- Fijar Canal** Presione \uparrow o \downarrow para seleccionar una de las siguientes opciones:
- 2-6:** Selecciónelos cuando desee controlar toda la selección de canales por medio de un decodificador o una videogradora. Seleccione el canal adecuado (normalmente el 3 o el 4) y utilice el control remoto del decodificador o de la videogradora para seleccionar los canales.
 - Video 1:** Seleccione esta opción desde las entradas de video disponibles cuando haya conectado el equipo de video (por ejemplo, el receptor de satélite) y desee que quede fijo en el televisor.
 - No:** Fijar Canal no está activado.

- Autoprogramación** Realice la función Autoprogramación siempre que ajuste el televisor. Recorrerá todos los canales disponibles y programará los que se reciben.

- Omitir/Añadir Canal** Utilice esta función después de ejecutar Autoprogramación para omitir los canales no deseados o para añadir nuevos canales.
- 1 Presione \uparrow o \downarrow para seleccionar la posición del canal deseado y después presione \rightarrow .
 - 2 Presione \uparrow o \downarrow para omitir o añadir canal y después presione \rightarrow .
 - 3 Presione \leftarrow para volver al menú de Canal o presione MENU \rightarrow para salir.

 Cuando presione CH+ o CH- no tendrá acceso a los canales omitidos, sólo a través de los botones CH - CH podrá sintonizarlos.

- Nombre del Canal** *Etiqueta hasta 40 canales con sus letras de llamada*
- 1 Presione \rightarrow y después presione \uparrow o \downarrow hasta que localice el número de canal deseado. Presione \rightarrow para activar el canal.
 - 2 Presione \downarrow para resaltar "Nombre" y después presione \rightarrow . Presione \uparrow o \downarrow para mostrar la primera letra de llamada o número de captura y después presione \rightarrow para seleccionarlo. Repita este proceso, hasta que halla seleccionado todas las letras.
 - 3 Presione \leftarrow para volver al menú de Canal o presione MENU \rightarrow para salir.

 No podrá utilizar las opciones Canales Favoritos, Cable, Omitir/Añadir Canal, Nombre del Canal y el menú de Bloqueo de Canal cuando Fijar Canal esté activado.

Uso del Menú Bloqueo de Canal

Para acceder al menú Bloqueo de Canal, siga los siguientes pasos:

Para mostrar



Para resaltar 











Para seleccionar



Presione  para resaltar la opción deseada y después presione .



- Bloquear o Desbloquear**
- 1 Presione  o  para seleccionar la posición (1 a 4) en la que desee bloquear o desbloquear un canal y después presione .
 - 2 Presione  o  para desplazarse por los canales hasta encontrar el canal que desee bloquear o desbloquear y después presione .
 - 3 Presione  para salir.

 Si un canal está bloqueado, se mostrará una pantalla negra con la palabra "Bloqueado", (solamente para el uso habitual del televisor). La función Bloqueo de Canal se desactiva en los modos de Video..





Uso del Menú Timer (Reloj)

Para acceder al menú Timer, siga los siguientes pasos:

Para mostrar  → **Para resaltar**  → **Para seleccionar** 









Hora Actual Permite ajustar el día y la hora actual en su televisor. Presione  para abrir el menú de Hora Actual:

- 1 Presione  o  para introducir el día y la hora y después presione .
- 2 Presione  para salir del menú.

 Debe ajustar la Hora Actual antes de poder utilizar Timer 1 y Timer 2 (Reloj 1 y Reloj 2).

Timer 1 y Timer 2 (Reloj 1 y Reloj 2) Programa su televisor al día, hora, duración y canal deseado. La programación máxima del reloj es de 6 horas. Cuando el canal esté fijado, no será necesario introducirlo.

Visualización programada

- 1 Presione  o  para seleccionar Timer 1 o Timer 2 (Reloj 1 o Reloj 2) y después presione .
- 2 Presione  o  para introducir el día, hora, duración y el canal deseado y después presione . Timer (Reloj) debe estar en Sí cuando se haya fijado, y se encenderá una luz roja en el panel frontal del televisor.
- 3 Presione  para salir del menú.

 Puede fijar Timer (Reloj) en las posiciones Sí, No o Programar. Cuando Timer 1 y Timer 2 (Reloj 1 y Reloj 2) esté ajustado podrá activarlo y desactivarlo sin tener que revisar los ajustes.



 Al ejecutar Autoprogramación, los ajustes de Timer 1 y Timer 2 (Reloj 1 y Reloj 2) se borrarán. Asimismo, en caso de producirse una pérdida de electricidad, los ajustes de Hora Actual, Timer 1 y Timer 2 (Reloj 1 y Reloj 2) se borrarán.

Uso del Menú Ajustes

















Para acceder al menú Ajustes, siga los siguientes pasos:

Para mostrar **Para resaltar**  **Para seleccionar**



Presione  para resaltar la opción deseada y después presione .



Caption Vision	Permite seleccionar tres modos de subtítulos (para programas que se emiten con subtítulos).
<i>Subtítulos</i>	<p>Presione  o  para seleccionar una de las opciones siguientes:</p> <p>CC1, 2, 3, 4: Muestra el diálogo impreso y los efectos de sonido de un programa.</p> <p>Text1, 2, 3, 4: Muestra información sobre la red o emisora.</p> <p>Info: Muestra el nombre del programa actual y el tiempo restante, si está disponible.</p> <p>No: Los subtítulos no están activados.</p>
Etiqueta de Video	Permite etiquetar los componentes de audio/video que tiene conectado a su televisor: videograbadora, reproductor de DVD, etc.
<i>Etiqueta el equipo conectado</i>	<p>1 Presione  o  para seleccionar la entrada que desee etiquetar y después presione .</p> <p>2 Presione  o  para elegir una etiqueta y presione .</p> <p>3 Presione  para volver al menú de Ajustes o presione  para salir.</p>
Rotación	Presione  o  para corregir la inclinación de la imagen entre -5 a +5 y después presione  para activarla.
Idioma	<p>Muestra todos los menús en el idioma elegido.</p> <p>Presione  o  para seleccionar el idioma deseado (Español, Inglés, Francés) y después presione .</p>
Modo 16:9	Proporciona una resolución mejorada de la imagen para fuentes de pantalla panorámica como el reproductor de DVD (sólo está disponible cuando el televisor esté en modo Video).
Demo	Presione  para efectuar una demostración de los menús en pantalla.
<i>(Demostración)</i>	

 Puede presionar cualquier tecla para salir del modo Demo (Demostración).

Uso del Menú Básico

Para acceder al menú Básico, siga los siguientes pasos:

Para mostrar



Para resaltar



Para seleccionar



Presione  para resaltar la opción deseada y después presione .

Menu Básico

Contraste  **Ajustar**







Caption Vision: No





Efecto: WOW

Menú Avanzado

Intensidad blanca

Mover:     Seleccionar:  Salir: 







Contraste <i>Contraste de la imagen</i>	Presione  para disminuir el contraste de la imagen. Presione  para aumentar el contraste de la imagen.
Caption Vision <i>Subtítulos</i>	En el menú Básico, Caption Vision solo muestra No y la última opción seleccionada (CC1-4, Text 1-4, o Info).
Efecto	Presione  o  para seleccionar una de las siguientes opciones y después presione  .
	Simulado: Simula el sonido estéreo de las salas de cine y teatro en los programas mono.
	WOW: Provee una espectacular presencia del sonido de los graves. Al activar WOW, BBE se activa directamente para mejorar aún más el programa de audio.
	TruSurround: Produce un sonido tridimensional dinámico en las señales de audio estéreo.
	No: Recepción mono o estéreo normal.
Menú Avanzado	Presione  para volver a los menús avanzados.

 Si utiliza el botón  para cerrar el menú Básico, éste aparecerá de nuevo cuando vuelva a presionar . Para acceder a los demás menús, presione  para resaltar el Menú Avanzado y después presione .

Información adicional

Programación del control remoto

Puede utilizar el control remoto incluido con equipos de video Sony y de otros proveedores.

- 1 Presione  .
- 2 Presione  o  (FUNCTION).
- 3 Utilice los botones  -  para introducir el número de código según la siguiente tabla.
- 4 Presione  .

Códigos de videograbadora

Sony	301, 302, 303	JCPenney	309, 305, 304, 330, 314, 336, 337
Admiral (M.Ward)	327	JVC	314, 336, 337, 345, 346, 347
Aiwa	338, 344	Kenwood	314, 336, 332, 337
Audio Dynamic	314, 337	LXI (Sears)	332, 305, 330, 335, 338
Broksonic	319, 317	Magnavox	308, 309, 310
Canon	309, 308	Marantz	314, 336, 337
Citizen	332	Marta	332
Craig	302, 332	Memorex	309, 335
Criterion	315	Minolta	305, 304
Curtis Mathis	304, 338, 309	Mitsubishi/MGA	323, 324, 325, 326
Daewoo	341, 312, 309	Multitech	325, 338, 321
DBX	314, 336, 337	NEC	314, 336, 337
Dimensia	304	Olympic	309, 308
Emerson	319, 320, 316, 317, 318, 341	Optimus	327
Fisher	330, 335	Panasonic	308, 309, 306, 307
Funai	338	Pentax	305, 304
General Electric	329, 304, 309	Philco	308, 309
Go Video	322, 339, 340	Philips	308, 309, 310
Goldstar	332	Pioneer	308
Hitachi	306, 304, 305, 338	Quasar	308, 309, 306
Instant Replay	309, 308	RCA/PROSCAN	304, 305, 308, 309, 311, 312, 313, 310, 329
Realistic	309, 330, 328, 335, 324, 338	Symphonic	338
Samsung	322, 313, 321	Tashiro	332
Sansui	314	Tatung	314, 336, 337
Sanyo	330, 335	Teac	314, 336, 338, 337

Códigos de videgrabadora

Scott	312, 313, 321, 335, 323, 324, 325, 326	Technics	309, 308
Sharp	327, 328	Toshiba	312, 311
Shintom	315	Wards	327, 328, 335, 331, 332
Signature 2000 (M.Ward)	338, 327	Yamaha	314, 330, 336, 337
SV2000	338	Zenith	331
Sylvania	308, 309, 338, 310		

Códigos de decodificadores de cable

Sony	230
Hamlin/Regal	222, 223, 224, 225, 226
Jerrold/G. I.	201, 202, 203, 204, 205, 206, 207, 208, 218
Oak	227, 228, 229
Panasonic	219, 220, 221
Pioneer	214, 215
Scientific Atlanta	209, 210, 211
Tocom	216, 217
Zenith	212, 213

Códigos de reproductores de discos láser

Sony	701
Panasonic	704, 710
Pioneer	702

Códigos de DBS

DIRECTV	809
Red Echostar/Dish	810

Códigos de receptor de satélite

Sony	801
General Electric	802
Hitachi	805
Hughes	804
Panasonic	803
RCA/PROSCAN	802, 808
Toshiba	806, 807

Códigos de reproductores de DVD











Sony	751
JVC	756
Mitsubishi	761
Onkyo	762
Oritron	759
Panasonic	753
Philips/Magnavox	757
Pioneer	752
RCA	755
Samsung/Hitachi	758
Toshiba	754
Zenith	760

 Si aparecen varios códigos, introdúzcalos por separado hasta que encuentre el código correcto para su equipo.









 Cuando retire las baterías del control remoto, es posible que los números de los códigos vuelvan a los ajustes de fábrica y sea necesario reconfigurarlos.

 En casos excepcionales, es posible que no pueda utilizar el equipo con el control remoto incluido. En tal caso, utilice el control original de dicho equipo.



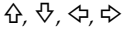

Uso de una videgrabadora

Presione	Para
	Encender la videgrabadora
	Seleccionar los canales directamente
	Cambiar de canal
	Reproducir cintas de video
	Detener el funcionamiento
	Desplazarse hacia adelante o hacia atrás
	Poner en pausa
 y 	Grabar
(Simultáneamente)	
	Alternar entre las entradas VCR y TV

Uso de un reproductor de DVD

Presione	Para
	Encender el reproductor de DVD
	Seleccionar capítulos directamente
	Buscar capítulos hacia adelante o hacia atrás
	Reproducir un DVD
	Detener el funcionamiento
	Poner en pausa
	Desplazar el cursor por el menú
	Mostrar el menú DVD



Uso de un reproductor de discos láser

Presione	Para
	Encender el reproductor de discos láser
	Buscar capítulos hacia adelante o hacia atrás
	Reproducir discos
	Detener el funcionamiento
	Poner en pausa

Solución de problemas

Si tiene problemas con el televisor, intente seguir las indicaciones que se sugieren a continuación. Si el problema persiste, consulte con su proveedor Sony más cercano.

Problema	Posibles Soluciones
Hace falta restablecer los ajustes de fábrica	<ul style="list-style-type: none"> <input type="checkbox"/> Encienda el televisor. Mientras mantenga oprimido el botón RESET del control remoto, oprima el botón de encendido (POWER) en el televisor. (El televisor se apagará). Suelte el botón RESET, enciéndalo nuevamente.
No hay imagen ni sonido	<ul style="list-style-type: none"> <input type="checkbox"/> Asegúrese de que el cable de alimentación está conectado. <input type="checkbox"/> Si hay una luz roja que parpadea en la parte frontal del televisor durante algunos minutos, desconecte y vuelva a conectar el cable de alimentación para restaurar el televisor. Si el problema persiste, llame al servicio técnico local. <input type="checkbox"/> Compruebe los ajustes de TV/VIDEO: si ve la televisión, póngalo en TV; si ve imágenes de un aparato de video, póngalo en VIDEO (página 4). <input type="checkbox"/> Asegúrese de que las baterías están introducidas correctamente en el control remoto (página 2). <input type="checkbox"/> Intente ver otro canal para descartar algún problema en la emisora.
Imagen de baja calidad o sin imagen, buen sonido	<ul style="list-style-type: none"> <input type="checkbox"/> Ajuste el Contraste en el menú de Video (página 24). <input type="checkbox"/> Ajuste el Brillo en el menú de Video (página 24). <input type="checkbox"/> Compruebe las conexiones de la antena o del cable (página 7).
Buena imagen, sin sonido	<ul style="list-style-type: none"> <input type="checkbox"/> Presione  para que desaparezca MUTING de la pantalla (página 3). <input type="checkbox"/> Compruebe los ajustes de Audio. Es posible que el televisor esté ajustado en Auto SAP o Bocinas se encuentre en la posición NO (página 26).
Sin color	<ul style="list-style-type: none"> <input type="checkbox"/> Ajuste Color en el menú de Video (página 24).
Sin señal	<ul style="list-style-type: none"> <input type="checkbox"/> Compruebe el ajuste del cable en el menú de Canal (página 27). <input type="checkbox"/> Compruebe las conexiones de la antena o del cable (página 7). <input type="checkbox"/> Asegúrese de que el canal seleccionado esté emitiendo señal.
Líneas de puntos o rayas	<ul style="list-style-type: none"> <input type="checkbox"/> Ajuste la antena. <input type="checkbox"/> Aparte el televisor de cualquier otro equipo electrónico. Algunos equipos electrónicos crean ruido eléctrico que puede interferir con la recepción del televisor.
Imágenes dobles o fantasmas	<ul style="list-style-type: none"> <input type="checkbox"/> Revise la antena exterior o llame al servicio técnico del cable.
No se reciben canales con un número alto (UHF) cuando se utiliza una antena	<ul style="list-style-type: none"> <input type="checkbox"/> Asegúrese de que Cable está en la posición No en el menú de Canal (página 27). <input type="checkbox"/> Ejecute Autoprogramación para añadir canales que actualmente no estén en la memoria (página 17).
Parece que no funcionan las emisoras de cable	<ul style="list-style-type: none"> <input type="checkbox"/> Asegúrese de que Cable está en la posición Si en el menú de Canal (página 27). <input type="checkbox"/> Ejecute Autoprogramación para añadir canales que actualmente no estén en la memoria (página 17).
El control remoto no funciona	<ul style="list-style-type: none"> <input type="checkbox"/> Al operar su televisor, oprima TV (FUNCTION). <input type="checkbox"/> Vea si colocó las baterías correctamente. <input type="checkbox"/> Las baterías pueden estar bajas. Sustitúyalas (página 2). <input type="checkbox"/> Aleje el televisor a 1 metro aproximadamente de cualquier lámpara fluorescente.

Problema	Posibles Soluciones
No se puede cambiar el canal con el control remoto	<ul style="list-style-type: none"> <input type="checkbox"/> Asegúrese de que no ha cambiado el televisor del canal 3 o 4 con otro dispositivo para cambiar canales. <input type="checkbox"/> Si está usando otro aparato para cambiar los canales, no olvide presionar el botón FUNCTION correspondiente a ese aparato. Por ejemplo, si está usando su grabadora para controlar los canales, asegúrese de presionar los botones VCR/DVD FUNCTION (página 3).
No puede acceder a otros menús con el menú Básico.	<ul style="list-style-type: none"> <input type="checkbox"/> Si utiliza el botón  para cerrar el menú Básico, éste aparecerá de nuevo cuando vuelva a presionar . Para acceder a los demás menús, seleccione menú Avanzado (página 32).
El control remoto no funciona en modo PIP	<ul style="list-style-type: none"> <input type="checkbox"/> Presione el botón TV FUNCTION. Es posible que accidentalmente haya presionado el botón VCR/DVD FUNCTION, que cambia los botones PIP al modo de grabadora (página 20).
No aparece la ventanilla en pantalla o no tiene imagen	<ul style="list-style-type: none"> <input type="checkbox"/> Asegúrese que la ventanilla se encuentre sintonizada con una fuente de video o un canal con programación al aire. <input type="checkbox"/> Es posible que se encuentre sintonizado con una entrada de video que no tiene nada conectado. Trate de recorrer sus entradas de video con el botón amarillo con el punto rojo PIP TV/VIDEO (página 20).
Se ve el mismo programa en la ventanilla que en la pantalla principal	<ul style="list-style-type: none"> <input type="checkbox"/> Es posible que ambas se encuentren sintonizadas al mismo canal. Trate de cambiar canales, ya sea en la pantalla principal o en la ventanilla (página 20). <input type="checkbox"/> Es posible que su televisor esté configurado para seleccionar todos los canales mediante un decodificador de cable. El decodificador de cable sólo decodificará una señal a la vez, por lo que usted no podrá utilizar la función PIP. Si es posible, conecte un cable directo a la toma VHF/UHF de su televisor. Esto sólo funcionará si su sistema de cable proporciona una señal no codificada (página 9).
Sólo puedo sintonizar señal de televisión en la ventanilla	<ul style="list-style-type: none"> <input type="checkbox"/> Asegúrese de que no configuró la etiqueta de video en el menú de Ajustes (página 31) para omitir sus entradas de video.
El televisor está sucio	<ul style="list-style-type: none"> <input type="checkbox"/> Limpie el televisor con un paño suave y seco. Nunca use solventes fuertes como diluyentes o bencina, puesto que pueden dañar el acabado de la unidad.
Perdió el control remoto	<ul style="list-style-type: none"> <input type="checkbox"/> Puede utilizar los controles del panel frontal de audio y video para acceder a los menús (página 2). Póngase en contacto con su proveedor Sony más cercano para solicitar uno de repuesto.
Aparece un cuadro negro en la pantalla	<ul style="list-style-type: none"> <input type="checkbox"/> Está seleccionada una opción de texto en el menú de Ajustes (página 31) y no hay texto disponible. Para desactivar esta función, seleccione NO en la opción Caption Vision (subtítulos). Si desea ver subtítulos, escoja CC1 en lugar de Texto 1-4.

Si después de leer este manual de instrucciones, tiene más preguntas relacionadas con el uso del televisor Sony, póngase en contacto con su proveedor Sony más cercano para recibir asistencia técnica.

Especificaciones

Sistema de televisión	Estándar de televisión estadounidense /NTSC
Cobertura de canales	VHF: 2-13/UHF: 14-69/CATV: 1-125
Antena	Terminal de antena externa para VHF/UHF de 75 ohm
Tubo de imagen	Cinescopio FD Trinitron®
Requisitos de alimentación para todos los países excepto en donde se indique:	ca 120 V 60 Hz ca 220 V 50/60 Hz (Chile, Perú, Bolivia)
Accesorios incluidos	Baterías (R6) de tamaño AA (2) Control remoto RM-Y181
Accesorios opcionales	Cables de conexión VMC-810S/820S, VMC-720M, YC-YC-15V/30V, RK74A Mezclador EAC-66 U/V TV stand SU-27HV1

KV-29FV300

Tamaño de la pantalla	Tamaño de pantalla visible: 679 mm medido en diagonal Tamaño de pantalla real: 736,6 mm medido en diagonal
Entradas/salidas	3 de video, 3 de audio 2 S VIDEO 1 Y, P _B , P _R , 1 de audio 1 Salida de Audio 1 Salida de Monitor
Salida de bocina	7.5 W × 2, 15 W Subwoofer
Consumo de energía para todos los países excepto en donde se indique:	220 W 210 W (Chile, Perú, Bolivia) 1 W en espera
Dimensiones (Anch. × Alt. × Prof.):	784 × 601,5 × 520 mm (30 ⁷ / ₈ × 23 ¹¹ / ₁₆ × 20 ¹ / ₂ pulgadas)
Peso	48 kg (105 lbs. 13oz)

El diseño y las especificaciones están sujetos a cambios sin previo aviso.

Índice alfabético

A

Agudos 25
Autoprogramación 17, 27
Auto Sap 26
Auto Volumen 25

B

Balance 25
Bloquear o desbloquear 29
Bocinas 26
Brillo 24

C

Cable 27
Canales Favoritos 27
Caption Vision 31
Características del televisor 1
ClearEdge VM 24
Color 24
Conexiones
 Cable y antena 7
 Decodificador y cable 9
 Decodificador y televisor 8
 Conexión de dos videograbadoras 12
 Conexión de una cámara de video 16
 Conexión de un reproductor de DVD 15
 Conexión de un sistema de sonido 16
 Conexión de un televisor, una videograbadora y un decodificador 11
 Conexión de un televisor, un receptor de satélite y una videograbadora 14
 Conexión de un televisor y una videograbadora 10
 Conexión de un televisor y un receptor de satélite 13
Contraste 24
Control remoto
 Programación 33
 Uso 3, 4

D

Demo(Demostración) 31
DISPLAY(Despliegue) 4
Dyna Black 24

E

Efecto
 No 25
 Simulado 25
 TruSurround 25
 WOW 25
Especificaciones 38
Etiqueta de Video 31

F

Fijar Canal 27

G

Graves 25

H

Hora actual 30

I

Idioma 31
Imagen dentro de una Imagen (PIP) 20
Instalación de baterías 2

M

Menús
 Ajustes 31
 Audio 25
 Básico 32
 Bloqueo de Canal 29
 Canal 27
 Timer (Reloj) 30
 Video 24
Modo 16:9 31
Modo
 Deportes 24
 Estándar 24
 Película 24
 Vívido 24
MTS
 Auto Sap 26
 Estéreo 26
 Mono 26

N

Nitidez 24
Nombre del Canal 28

O

Omitir/Añadir Canal 28

P

Panel frontal del televisor 2
Panel posterior del televisor 5

R

Rotación 31

S

Salida de Audio 26
SLEEP 3
Solución de problemas 36

T

Temperatura del Color 24
Timer 1 y Timer 2 (Reloj 1 y Reloj 2) 30
Tinte 24

SERVICE MANUAL

BA-5D CHASSIS

<u>MODEL NAME</u>	<u>REMOTE COMMANDER</u>	<u>DESTINATION</u>	<u>CHASSIS NO.</u>
KV-27FV300	RM-Y181	US	SCC-S65AA
KV-27FV300	RM-Y181	CND	SCC-S64AA
KV-29FV300	RM-Y181	LATIN NORTH	SCC-S62BA
KV-29FV300	RM-Y181	LATIN SOUTH	SCC-S62CA
KV-32FV300	RM-Y182	US	SCC-S65BA
KV-32FV300	RM-Y182	CND	SCC-S64BA
KV-36FV300	RM-Y182	US	SCC-S65CA
KV-36FV300	RM-Y182	CND	SCC-S64CA
KV-36FV300	RM-Y182	HAWAII	SCC-S67AA

CORRECTION - 1

SUBJECT: CRITICAL PARTS INCORRECTLY IDENTIFIED IN EXPLODED VIEW,
ELECTRICAL PARTS LIST, A BOARD SCHEMATIC

Correct the service manual as shown.
File this Correction with the service manual.

 : Corrected Item



SECTION 6: EXPLODED VIEWS

6-1. CHASSIS (KV-27FV300/29FV300 ONLY) (Page 55)

INCORRECT

REF. NO.	PART NO.	DESCRIPTION
 9	8-598-593-00	TUNER, FSS BTF-WA421
14	1-771-787-12	SWITCH, RF ANTENNA

CORRECT

REF. NO.	PART NO.	DESCRIPTION
 9	8-598-593-00	TUNER, FSS BTF-WA421
 14	1-771-787-12	SWITCH, RF ANTENNA

SECTION 7: ELECTRICAL PARTS LIST (Page 70)

INCORRECT

REF. NO.	PART NO.	DESCRIPTION
 TU001	8-598-593-00	TUNER, FSS BTF-WA421

CORRECT

REF. NO.	PART NO.	DESCRIPTION
 TU001	8-598-593-00	TUNER, FSS BTF-WA421

TRINITRON® COLOR TELEVISION
SONY®

A BOARD SCHEMATIC DIAGRAM

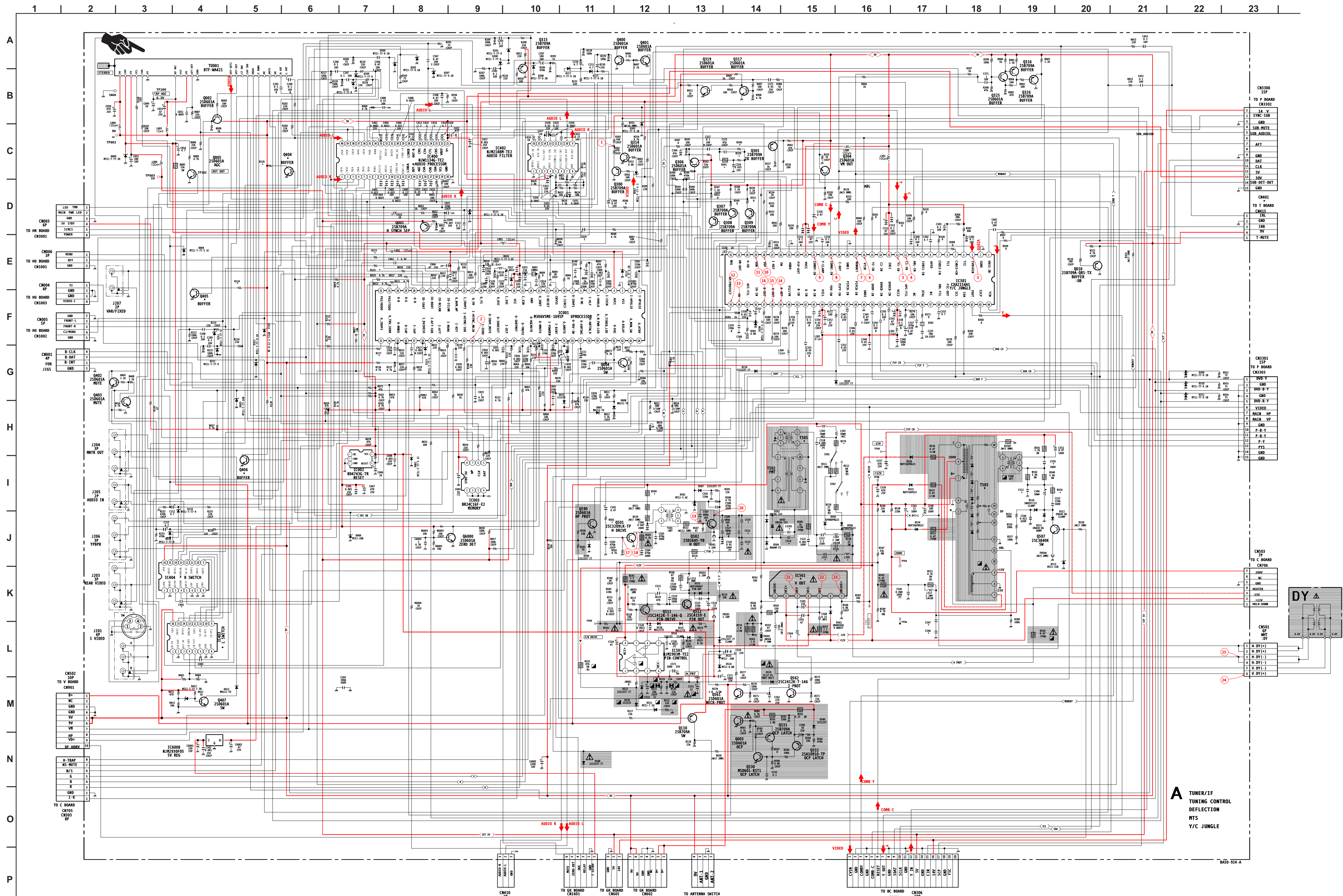

SERVICE MANUAL

BA-5D CHASSIS

<u>MODEL NAME</u>	<u>REMOTE COMMANDER</u>	<u>DESTINATION</u>	<u>CHASSIS NO.</u>
KV-27FV300	RM-Y181	US	SCC-S65AA
KV-27FV300	RM-Y181	CND	SCC-S64AA
KV-29FV300	RM-Y181	LATIN NORTH	SCC-S62BA
KV-29FV300	RM-Y181	LATIN SOUTH	SCC-S62CA
KV-32FV300	RM-Y182	US	SCC-S65BA
KV-32FV300	RM-Y182	CND	SCC-S64BA
KV-36FV300	RM-Y182	US	SCC-S65CA
KV-36FV300	RM-Y182	CND	SCC-S64CA
KV-36FV300	RM-Y182	HAWAII	SCC-S67AA

CORRECTION- 2

SUBJECT: EXPLODED VIEW PARTS NUMBER CORRECTION

Correct the service manual as shown.
File this Correction with the service manual.

 : Corrected Item

Section 6: Exploded View (Pages 56, 58, & 60)

6-2. Picture Tube (KV-27FV300/29FV300 Only)

6-4. Picture Tube (KV-32FV300 Only)

6-6. Picture Tube (KV-36FV300 Only)

TRINITRON® COLOR TELEVISION

SONY®

 : Corrected Item

Section 6: Exploded View (Pages 56, 58, & 60)

6-2. Picture Tube (KV-27FV300/29FV300 ONLY)

INCORRECT

CORRECT

REF. NO.	PART NO.	DESCRIPTION	REF. NO.	PART NO.	DESCRIPTION
28	4-087-375-01	DOOR, CONTROL	 28	4-087-375-11	DOOR, CONTROL

6-4. Picture Tube (KV-32FV300 ONLY)

INCORRECT

CORRECT

REF. NO.	PART NO.	DESCRIPTION	REF. NO.	PART NO.	DESCRIPTION
31	4-087-375-01	DOOR, CONTROL	 31	4-087-375-11	DOOR, CONTROL

6-6. Picture Tube (KV-36FV300 ONLY)

INCORRECT

CORRECT

REF. NO.	PART NO.	DESCRIPTION	REF. NO.	PART NO.	DESCRIPTION
31	4-087-375-01	DOOR, CONTROL	 31	4-087-375-11	DOOR, CONTROL